

LIBRARY

ELECTRIC RAILWAY ENGINEERING

BY

H. F. PARSHALL, M. INST. C. E.

CONSULTING ENGINEER

AND

H. M. HOBART, M. I. E. E.

CONSULTING ENGINEER

LONDON
ARCHIBALD CONSTABLE & CO., LTD
1907

NOT RELEVANT

27 1

11 ABBEY, AGNEW, & CO., LTD., PRINTERS,
LONDON AND TORONTO.

Preface

THE introduction of electricity into railway working, greatly widens the scope of electrical engineering. Heretofore the application of electricity has been of a comparatively limited nature, since the amount of power that may be usefully applied for lighting, traction, or industrial purposes is largely limited by, and commensurate with, the population served. In the case of railway working these limitations do not exist. There are practically no limitations as to the amount of power or the distance to which it may be transmitted, other than those imposed by competition between steam and electric traction.

While the mechanical fitness of an electrical system has been proved by such installations as the Baltimore Tunnel, the New York New Haven and Hartford Railway, the New York Central, the North-Eastern, the Lancashire and Yorkshire, and the Central London Railway, the commercial limitations imposed by its relatively greater first cost have yet to be demonstrated. The installations under construction, like those of the New York Central, the New York New Haven and Hartford, and the Pennsylvania Railways, will go far towards demonstrating the extent to which electric traction may compete with the steam locomotive.

The considerations which have led to the adoption of electric traction on the larger steam railways have generally been peculiar to the local circumstances. For instance, in the cases of the Baltimore Tunnel and the New York Central Railway the first consideration was to avoid the smoke nuisance in tunnels. With regard to the latter railway, once the necessity for electric traction had been realised, the question of additional improvements was taken into consideration, and such elaborate alterations to sidings, stations, and terminal arrangements were deemed advisable to suit the more rapid electrical working, that the cost as a whole was several times that necessarily incident to the change from steam to electricity.

The electrical installation must of necessity, to compete with steam, be capable of dealing with a greater maximum demand per hour in passenger accommodation, since, with its power station, transforming system, and train equipment, it is of greater cost than the steam locomotive. The electrical installation, with its higher speeds and better acceleration, possesses greater mobility than a steam equipment, and the train may be easily split up into self-contained units to suit the varying demands of the traffic. Except in the case of exceedingly dense and steady traffic, the cost of working by electricity will, apparently for a long time to come, be greater than that of working by steam. It frequently happens in railway working that the advantages or disadvantages of a particular kind of train service for working in or about the terminus of a great railway should not be dealt with by themselves, but rather as a feature of the system in its entirety. Thus it often occurs that the commercial limitations of a railway are determined by the facilities at its termini, and that improved facilities may mean an increase in the earning capacity of the line. Frequently the operation of main line trains is limited by the necessities of local traffic. There are numerous cases of this description where electricity may be relied upon to improve the condition of a system as a whole, although the local commercial advantages, taking the increased

PREFACE

cost as compared with the increased local traffic, are not at first apparent. These distances will undoubtedly extend as time goes on, since, with the great improvements being effected in steam-driven generating apparatus, the higher pressures at which motors may be safely worked, and the redistribution of population incident to more rapid transit, the conditions now deemed favourable for electrical working on short lines will become common on lines extending over considerable distances.

In the application of electricity to long distance lines, it is to be steadily borne in mind that the steam locomotive has demonstrated itself to be the most efficient self-contained machine, considering its varying functions, that the engineer has yet devised, and that, to compete with this machine, every appliance entering into the electric traction installation must compare from every point of view, as regards efficiency, with this most highly developed and perfect mechanism, and that the electric locomotive installation duplicates, in many respects, the steam locomotive installation.

It is not our purpose to undertake to predict the form that the ultimate electric railway installation may assume. Standardisation has been one of the great elements of success in steam railway working, and the future growth of electric traction will be slow until the standardisation phase has been reached. At the present time there exists a wide difference of opinion among engineers as regards the commercial advantages of alternating current and continuous current motors for traction. In our judgment, the limitation of the alternating current motor is fixed, in its relation of energy output to weight, by the inherent properties of single-phase commutator apparatus, and that the limitation of the continuous current motor will be determined by the maximum safe voltage at which a commutating machine can be worked. While the development of each class of machine has advanced beyond the point that could reasonably have been foreseen, and while in our judgment it is impossible at the present time to predict where the limitations will be reached, we are satisfied that a careful comparison of the two types at the present time is decidedly to the advantage of the high tension continuous current motor. The primary mechanical advantage of electric traction is obtained with either class of apparatus, owing to the fact that power may be distributed over the train and applied to as many axles as may be necessary to secure the best mechanical result.

There is not much to choose between the methods of control as between alternating current and continuous current, and in the main the points to be proved in the working of the two systems will be found to lie in the maintenance of the motor and train equipments. The terms adopted in the comparison of the properties of the two classes of machines leave much to be desired. In the maintenance of a train equipment a serious item is that of keeping the armature central in the fields: hence it is fundamental that motors of like power should, when compared, have the same mechanical characteristics as regards weight and speed of rotor, and mechanical clearance. Another condition we would emphasise is that for the same speed the motors should have the same torque per ampere intake, and the same percentage of line voltage at the terminals. We are tempted to emphasise this point, since it is entirely misleading to the railway engineer to compare the electrical results without making mention of mechanical and other differences that primarily affect the whole question of operation and maintenance.

With the gradual extension of the application of electricity for all purposes along the different railway systems, the distance to which electrical working becomes

PREFACE

profitable, will be extended, and with the installation of such power systems as are now becoming common in Great Britain, it would appear that the distance may be indefinitely extended.

The advantages of electric traction, like those of the central power installation, increase with the magnitude. The diversity and load factors increase therewith, as also the various economies incidental to an improved load factor. As an ultimate result, freight haulage may be anticipated. The electrical output per mile of track must be considerable to bring the cost of haulage per ton-mile by electricity to that now common by steam.

In the following pages we have endeavoured to place in an accessible form, a portion of the results of our own observations and experience in this most important department of engineering, and we have referred to and quoted from the work of other writers in instances where the usefulness of the book is thereby increased. We fully realise that the book is incomplete in many respects, but having regard to the amount of time already taken in its preparation, further delay in its publication does not seem warranted.

The authors wish to take this opportunity of making due acknowledgment of the assistance rendered them by engineers, technical journals, manufacturers, and others.

In the former class should be mentioned Messrs. Evan Parry, W. Casson, F. W. Carter, Prof. Ernest Wilson, F. Punga, A. S. Garfield, T. Stevens, B. Valatin, C. W. G. Little, P. von Kalnassy, W. C. Gotshall, W. M. Camp, O. Lasche, G. Wüthrich, and A. G. Ellis.

A number of manufacturing and operating companies have kindly supplied us with valuable data. Amongst others may be mentioned Messrs. The Oerlikon Co., The British Thomson-Houston Co., The British Westinghouse Co., Ganz & Co., The Brush Electrical Engineering Co., and the Interborough Rapid Transit Co. of New York.

Amongst the technical periodicals which have extended us courtesies in the supplying of data, and in granting permission to quote from their columns, we would mention *The Street Railway Journal*, *The Electrical Review*, *The Electrician*, *The Tramway and Railway World*, *The Engineer*, *Engineering*, *The Light Railway and Tramway Journal*, *Elektrotechnische Zeitschrift*, *Zeitschrift des Vereines Deutscher Ingenieure*, and *Elektrische Bahnen und Betriebe*.

For permission to quote from their proceedings we have to express our thanks to the Institutions of Civil Engineers, Electrical Engineers, Mechanical Engineers, and the American Institutes of Electrical Engineers and Mining Engineers.

Table of Contents

	PAGE
PREFACE	v
 PART I THE MECHANICS OF ELECTRIC TRACTION 	
CHAPTER I	
TRACTION RESISTANCE AT CONSTANT SPEED	3
CHAPTER II	
ACCELERATION	21
CHAPTER III	
THE TRACTIVE FORCE AND THE POWER AND ENERGY AT THE AXLES	40
CHAPTER IV	
THE STUDY OF THE CHARACTERISTICS OF ELECTRIC RAILWAY MOTORS, AND OF SECTION CHARACTERISTICS AND THE CONSTRUCTION OF LOAD CURVES	54
 PART II THE GENERATION AND TRANSMISSION OF THE ELECTRICAL ENERGY 	
CHAPTER V	
THE ELECTRICAL POWER GENERATING PLANT	101
CHAPTER VI	
THE HIGH TENSION TRANSMISSION SYSTEM	140
CHAPTER VII	
THE SUB-STATIONS	172
CHAPTER VIII	
THE DISTRIBUTING SYSTEM	214

TABLE OF CONTENTS

PART III

THE ROLLING STOCK

CHAPTER IX

LOCOMOTIVES AND MOTOR CARRIAGES AND THEIR ELECTRICAL EQUIPMENT	PAGE
	291

CHAPTER X

TRUCKS	430
--------	-----

INDEX	465
-------	-----

List of Illustrations

PART I

THE MECHANICS OF ELECTRIC TRACTION

FIG.	PAGE
1. Curves of Tractive Resistance at Low Speeds for an 83-Ton 75-foot Car, as deduced from the Berlin-Zossen Tests	4
2. Curves of Tractive Resistance for Various Lengths of Train	6
3. Curves of Tractive Resistance for 83-Ton 75-foot Car	7
4. Curves for Tractive Resistance according to well-known Formulae. Single Car Operation. Weight of Car about 22 Tons	8
5. Same as Fig. 4, but for Train of Five 40-Ton Carriages, say 200 Tons	9
6. Curves of Tractive Resistance in Tube Railways	9
7. Curves of Tractive Resistance in Tube Railways and on Surface	10
8. Curves of Component and Resultant Tractive Resistance for 83-Ton 75-foot Car, deduced from Berlin-Zossen Tests	11
9. Percentage of Passenger Weight to Total Train Weight (Grand Central Station to Mott Haven Junction)	12
10. Curves of Tractive Resistance in Pounds per Ton for Various Speeds in Miles per Hour	15
11. Curves of Tractive Resistance in Pounds per Ton for Various Speeds in Feet per Second	16
12. Curves of Power in Kilowatts at the Axles per Ton Weight of Train	16
13. Curves of Total Power in Kilowatts at Axles	17
14. Carter's Train Resistance Curves, giving the Variable Component of Train Resistance	18
15. (A, B, C, D, E, and F). Speed, distance, and time Curves for Various Accelerations <i>To face</i>	22
16. Speed-distance-time Curves (Armstrong's)	23
17. Speed-distance-time Curves	24
18. (A, B, and C). Speed-distance-time Curves for a 1-mile Run at an Average Speed of 30 Miles per Hour. Time from Start to Stop = 2 Minutes	25
19. Speed-time and Distance-time Curves for Various Accelerations and Average Speeds. $\frac{1}{2}$ -mile Run	<i>To face</i> 26
20. Speed-time and Distance-time Curves for Various Accelerations and Average Speeds. 1-mile Run	<i>To face</i> 26
21. Speed-time and Distance-time Curves for Various Accelerations and Average Speeds. 2-mile Run	<i>To face</i> 26
22. Speed-time and Distance-time Curves for Various Accelerations and Average Speeds. 4-mile Run	<i>To face</i> 26
23. Speed-time and Distance-time Curves for Various Accelerations and Average Speeds. 8-mile Run	<i>To face</i> 26
24. Maximum Speeds for Different Lengths of Sections and Various Accelerations and Schedule Speeds, and Various Durations of Stop	27
25. Curves of Acceleration and Schedule Speed for Various Distances between Stops <i>To face</i>	28
26. Curves of Limiting Attainable Schedule Speeds for given Mean Rates of Acceleration and Braking	30
27. Speed-time Curve for a 65 (Metric) Ton Electric Train of Motor Cars (no Trailers)	31
28. Speed-time Curve for a Constant Acceleration of 2.2 Miles per Hour per Second. Average Speed 40 Miles per Hour	31
29. Speed-time Curves for a Mean Acceleration of 2.2 Miles per Hour per Second. Average Speed 40 Miles per Hour	31
30. To Illustrate Case of Running on "Motor Curve"	32

LIST OF ILLUSTRATIONS

FIG.	PAGE
31. Speed-time and Speed-distance Curves for an Average Speed of 40 Miles per Hour for Runs of Various Lengths	33
32. Speed-time-distance Curves for an Average Speed of 60 Miles per Hour for 2, 4, and 8-mile Runs from Start to Stop	35
33. Speed-distance-time Curves for 4-mile Section	36
34. Values of $\frac{V_{max.}}{V_{av.}}$ and of $\frac{b}{B}$	38
35. Charts showing Tractive Force with Various Accelerating Rates for Trains of Different Weights	40
36. Charts showing Tractive Force with Various Accelerating Rates for 200-ton Train	41
37. Curves of Speed, Tractive Force, Power, and Energy at Axle. 200-ton Train operated between Stops at an Average Speed of 30 Miles per Hour, with One Stop per Mile	42
38. Curve of Watt-hours at Axles per Ton-Mile for 200-ton Train operating with One Stop per Mile at an Average Speed of 30 Miles per Hour between Stops, and with Varying Rates of Acceleration	43
39. Curve of Maximum Instantaneous Power at Axles in Kilowatts per Ton Weight of Train. 200-ton Train operated with One Stop per Mile at an Average Speed of 30 Miles per Hour between Stops for Different Rates of Uniform Acceleration. Rate of Retardation taken as equal to Rate of Acceleration	44
40. Curve of Average Power from Start to Stop in Kilowatts at Axles per Ton Weight of Train operated with One Stop per Mile at an Average Speed of 30 Miles per Hour between Stops, for Different Rates of Uniform Acceleration	44
41. Curves for Tranear operated on Ordinary Series Parallel and on Regenerative Control Systems	46
42. Tranear Relative Inputs at Different Speeds on Level Track	47
43. Curves of Energy and Maximum Instantaneous Power at Axles	48
44. Curves of Energy required at Axles of 200-Ton Train for Various Lengths of Run and Schedule Speeds	49
45. Curves of Energy Input to 200-Ton Train for Various Lengths of Run and Schedule Speeds	50
46. Curves showing Relation between the Accelerating Rate and the Ratio of the Maximum to the Average Power at the Axles. 200-Ton Train operated with One Stop per Two Miles, at an Average Speed of 30 Miles per Hour between Stops	50
47. Typical Train Characteristic (S.T.) Curves for Trains operated by Continuous Current	51
48. Typical Train Characteristic (S.T.) Curves for Continuous Current Equipments	52
49. To explain Connection between Speed and Input of Ideal Series Motors	55
50. Curves showing Efficiency, Speed, and Tractive Force of G.E. 66 A. Motor of 125 H.-P. Rated Output	56
51. To explain Connection between Speed and Input of G.E. 66 A. Motor	58
52. To explain Connection between Tractive Force and Input using Four G.E. 66 A. Motors	60
53. To explain Connection between Tractive Force (Curve I), Initial Accelerating Rate (Curve II.) and Input, using Four G.E. 66 A. Motors	61
54 to 59. Acceleration-current-speed-time Curves for Four G.E. 66 A. Motors in Parallel	<i>To face</i> 62
60. Characteristic Curves of Parallel Operation of Four G.E. 66 A. Motors	64
61. Characteristic Curves of Parallel Operation of Four G.E. 66 A. Motors	65
62 and 63. Characteristic Curves of Parallel Operation of Four G.E. 66 A. Motors	66
64 to 66. Acceleration-current-speed-time Curves for Four G.E. 66 A. Motors in Parallel	<i>To face</i> 66
67 to 70. Acceleration-current-speed-distance-time Curves for Four G.E. 66 A. Motors in Parallel	<i>To face</i> 66
71. Curves Allocating the Distribution of the Energy with Four 66 A. Motors in Parallel	68
72. Curves of Input and Output for Four G.E. 66 A. Motors in Parallel	70
73 to 75. Speed, Tractive Force, and Power Curves for Four G.E. 66 A. Motors in Parallel and assuming Straight Line Acceleration and Retardation	71
76. Series Parallel Operation of Four G.E. 66 A. Motors	72

LIST OF ILLUSTRATIONS

FIG.	PAGE
77. Characteristic Curves of Series Parallel Operation of Four G.E. 66 A. Motors, with a Gear Ratio of 3:94, and with 34 in. Driving Wheels. 125-Ton Train. Level Track <i>To face</i>	72
78 to 80 and 84. Relating to Method of Series-Parallel Control corresponding to Method B. of Table XX. <i>To face</i>	72
81 to 83 and 85. Relating to Method of Series-Parallel Control corresponding to Method C. of Table XX. <i>To face</i>	72
86 to 89. Time-tractive Force Speed Curves <i>To face</i>	76
90. Characteristic Curves for a $\frac{1}{2}$ -mile Run at an Average Speed of 19 Miles per Hour. 120-Ton Train. Level Track. No Coasting.	77
91. Characteristic Curves for a $\frac{1}{2}$ -mile Run at an Average Speed of 18.4 Miles per Hour. 120-Ton Train. Level Track. Coasting for 39 Seconds	78
92. Characteristic Curves for a $\frac{1}{2}$ -mile Run at an Average Speed of 16.1 Miles per Hour. 120-Ton Train. Level Track. Coasting for 72 Seconds	78
93. Characteristic Curves for a $\frac{1}{2}$ -mile Run at an Average Speed of 13.4 Miles per Hour. 120-Ton Train. Level Track. Coasting for 107 Seconds	79
94. Characteristic Curves for a $\frac{1}{2}$ -mile Run at an Average Speed of 19 Miles per Hour, and with Coasting for 23 Seconds. 120-Ton Train. Level Track <i>To face</i>	80
95. Characteristic Curves for a $\frac{1}{2}$ -mile Run at an Average Speed of 19 Miles per Hour, and with Coasting for 32 Seconds. 120-Ton Train. Level Track <i>To face</i>	80
96. Characteristic Curves for a $\frac{1}{2}$ -mile Run at an Average Speed of 19 Miles per Hour. 120-Ton Train. Grades as set forth in Table XXIV. <i>To face</i>	80
97. Characteristic Curves of G. E. 66 A. Motor for three different Gear Ratios <i>To face</i>	82
98. Characteristic Curves of Series Parallel Operation of four G.E. 66 A. Motors with a Gear Ratio of 4.73, and with 34-inch Driving Wheels. 125-Ton Train. Level Track <i>To face</i>	82
99. Typical Temperature Curve for an intermittently-loaded Motor.	83
100. Curve showing the Temperature Rise of a Railway Motor when running on a Service with long Coasts and frequent Stops <i>To face</i>	84
101. The Effect of frequent Stops in High Speed Railroading (A. H. Armstrong, <i>Street Railway Journal</i> , Vol. XXIII., p. 70, January 9th, 1904)	85
102. Energy Consumption for a 32-Ton Car at Various Schedule Speeds	86
103. Carter's Curve of Rated Capacity of Electrical Equipment	87
104. Curves for deriving the Kilowatts Input per Ton to a 30-Ton Car for Various Schedule Speeds and Various Stops per Mile. Duration of Stop = 20 Seconds	89
105. Armstrong's Curves for showing the variations in Train Resistance with Size and Speed of Train <i>To face</i>	89
106. Curves of Tractive Resistance for Single Cars of Various Weights according to Wympe (Blood's Formula)	90
107. Curves compiled from Carter's Data on Weights of Continuous Current Equipments	92
108. Curves of Total Energy Consumption at the Contact Shoe per Ton-mile	93

PART II

THE GENERATION AND TRANSMISSION OF THE ELECTRICAL ENERGY

109. Central London Railway: Daily Load Curve	102
110. Diagram for Estimating Condenser Capacities <i>To face</i>	114
111. Central London Railway: Plan of Power Station	116
112. Central London Railway: Cross-section of Power Station	117
113. Glasgow Corporation Tramways: Plan of Power Station <i>To face</i>	120
111. Glasgow Corporation Tramways: Cross-section of Power Station	121
115. Bristol Tramways: Cross-section of Power Station	125
116. Dublin United Tramways: Cross-section of Power Station	128
117. Arrangement of Boiler Plant of Dublin United Tramways Generating Station <i>To face</i>	128
118. Plan of Engine Room of Dublin United Tramways Generating Station <i>To face</i>	128

LIST OF ILLUSTRATIONS

	PAGE
116.	131
119. Design of 10,000-k.w. Power Station. Plan	131
120. Design of 10,000-k.w. Power Station. Cross-section	132
121. Comparison of Efficiencies of English and Foreign Electrical Generating Stations	135
122. Costs of High-tension Three-core Cables	143
123. Curves showing the Ratio of the Cost of Three-core Cables complete, to the Cost of Copper contained in the Three Cores for 500 to 20,000 Volts between Cores	144
124. Costs of Cables for Transmission Lines, for transmitting 1,000 to 16,000 k.w. to a distance of 10 to 14 kilometres at Power Factors of 1.0 and 0.8	144
125 to 128. Curves showing Minimum Costs of Cables for transmitting 1,000 to 8,000 k.w. to a Distance of 10 to 40 kilometres	146
129. Kavanagh's Curves of Current Densities in Cables	150
130. Current-carrying Capacity of British Standard Cables	151
131. Ferguson's Tests of Temperature Distribution in Cables	152
132 and 133. Ferguson's Curves showing Temperature Rise in Cables	152
134. New York Subway: Arrangement of Cable Ducts under Street	154
135. New York Subway: Location and Arrangement of Cable Ducts inside Wall of Tunnel	154
136. New York Subway: Arrangement of Cable Ducts under Passenger Station	155
137. New York Subway: Arrangement of Cables in Manhole	156
138. New York Subway: Cable	157
139. Arrangement of Central London Railway Cables	157
140. District Railway: Cables Mounted on Wall, showing Joints	159
141. District Railway: Section through High Tension Cable-Joint	160
142. District Railway: Manhole in Transmission Line under Construction	161
143. Sections of Various High-tension Cables	162
144. Section of Henley's Patent Lamina Conductor Three-core Cable	162
145. Curve showing Voltage required at Generator for 23,100 Volts per Phase at Receiving End with Different Power Factors	170
145A. New York Central Railway: Plan, Elevation, and Sections of Pole for Transmission Lines	170
146 to 148. Phase Characteristics of Hypothetical Synchronous Motors	174
149. Phase Characteristics of Synchronous Motor for 900-k.w. Input at Rated Load	176
150. Saturation Curve of a 600-k.w. Rotary Converter	178
151. Curves showing Amperes Input per Phase at Various Loads of a 600-k.w. Rotary Converter	179
152, 158 and 159. Curves of Efficiency and Power Factor of a 600-k.w. Rotary Converter	182
153 to 157. Diagram for determining Generator Voltage at Various Loads	181
160 to 163. Rotary Converter Compounding Curves	186
164 and 165. Rotary Converter Regulation Curves	188
166 and 167. Full Load Voltages at Commutators of Rotary Converters	188
168. 400-k.w. Rotary Converter Characteristic Phase Curves	189
169. Booster Volt-ampere Characteristic Curves	193
170. Battery Volt-ampere Characteristic Curves	193
171. Connection Diagram for Battery-Booster Set in Parallel with Two Shunt-wound Rotary Converters	194
172. Curves of Regulation of Rotary Converter, Battery, and Booster	194
173. Diagrams showing Subdivision of the Current between Rotaries and Battery	195
174. Curves showing Distribution of Load between Rotaries and Battery Booster	195
175. Five Minutes Load Curve	196
176. Connections of Three-phase Rotary with Compensator	205
177. Diagram of Connections for Synchronising and Switching applicable to Six-phase Rotary Converters	207
178. Diagram of Connections applicable to Three-phase Rotaries	207
179. Central London Railway: General Arrangement of Marble Arch Sub-station	208
180. Central London Railway: Notting Hill Gate Sub-station Main Switchboard	213
181. Central London Railway: Diagram of Connections of Two Sub-stations	212
182. Central London Railway: Arrangement of High Tension Bus Bars and Ammeter Transformer	213

LIST OF ILLUSTRATIONS

FIG.	PAGE
183. Central London Railway: Back View of Sub-station Switchboard. High Tension and Low Tension Feeder Panels	211
184. Central London Railway: Back View of Sub-station Switchboard. Transformer and Converter Panels	211
184A. Central London Railway: Front View of High Tension Panels, showing Three-phase Switch	215
185. Central London Railway: Notting Hill Gate Sub-station. Bank of 300-k.w. Transformers	216
186. Central London Railway: Notting Hill Gate Sub-station. 300 k.w. Transformer. Elevations and Plan	217
187. 300-k.w. Central London Railway Transformer, Efficiency and Losses	217
188. Central London Railway: Samuelson's Triple Pole Quick Brake Switch for Rotary Converter	218
189. Central London Railway: 900-k.w. Rotary Converter	<i>To face</i> 218
190. Central London Railway: 900-k.w. Rotary Converter	219
191. Central London Railway: Curves of Efficiency and Losses of 900-k.w. Rotary Converter	219
192. Central London Railway: Magnetisation Curve of 900-k.w. Rotary Converter	220
193. Central London Railway: Phase Characteristic of 900-k.w. Rotary Converter	220
194. Metropolitan Railway: Ruislip and Harrow Sub-stations	222
195. Metropolitan Railway: Ruislip and Harrow Sub-stations	223
196. District Railway: Plan of Charing Cross Sub-station	224
197. District Railway: Gallery Elevation, Charing Cross Sub-station	225
198. District Railway: Diagram of Connections at Charing Cross Sub-station	226
199. District Railway: Putney Bridge Sub-station Switchboard	227
200. District Railway: Type C. Oil Switch in Sub-station	228
201. North-Eastern Railway: Ground Plan of Typical Sub-station	229
202. North-Eastern Railway: Longitudinal Section of Sub-station	230
203. North-Eastern Railway: Cross Section of Sub-station	230
204. North-Eastern Railway: Westinghouse Oil-Break High Tension Switches	231
205. North-Eastern Railway: Electrical Connections at Pandon Dene Sub-station	233
206. New York Subway: Converter Floor Plan of Sub-station No. 14	237
207. New York Subway: Cross Section of Sub-station No. 14	238
208. New York Subway: Longitudinal Section of Sub-station No. 14	239
209. New York Subway: Operating Gallery in Sub-station	240
210. Curve for Resistance and Composition of Steel	246
211. Curves showing the Effect of Carbon and Manganese on the Conductivity of Steel	247
212. Methods of Mounting and Insulating Conductor Rails	250
213. Conductor Rail Insulator. London Underground Electric Railways Co.	250
214. Pedestal Type of Rail Insulator	251
215. Reconstructed Granite Co.'s Insulators	252
216. Chambers' Patent Third Rail Insulator	253
217. Methods of Protecting Conductor Rails	253
218. N.Y.C. Showing Arrangement of Under Contact Third Rail	254
219. The Farnham "Under Contact" Protected Third Rail System	255
220. Sections of Single Track on Various Railways	<i>To face</i> 256
221. Sections of Double Track on Various Railways	257
222. Sections of Various Types of Conductor and Track Rails in Common Use	258
223. Photograph showing Single Cable Suspension with Side Poles as erected by the Westinghouse Co.	261
224. Photograph showing Double Cable Suspension supported from Gantries constructed by the Westinghouse Co.	262
225. Side Pole Single Insulation, Single Cable Suspension, (British Thomson-Houston Co.)	263
226. Side Pole Double Insulation Single Cable Suspension with Vertically Yielding Anchorage, (British Thomson-Houston Co.)	264
227. Side Pole and Bracket Arm, with Insulators and Stay, (British Westinghouse Co.)	265
228. Bracket Arm Insulator, (British Westinghouse Co.)	265
229. Insulated Stay for Trolley Wire for attaching to Bracket Arm, (British Westinghouse Co.)	266

LIST OF ILLUSTRATIONS

FIG.		PAGE
230.	Section Insulator. (British Westinghouse Co.)	266
231.	Method of Sectionalising Conductor. (British Thomson-Houston Co.)	267
232.	Hanger of Suspender. (British Westinghouse Co.)	268
233.	Curve Pull-off. (British Westinghouse Co.)	268
234.	Gantry for Two Tracks, supporting Two Conductors on the Single Cable Principle with Double Insulation. (British Thomson-Houston Co.)	268
235.	Gantry Constructions for Two, Four, and Six Tracks, with Double Cable Suspension. (British Thomson-Houston Co.)	<i>To face</i> 268
236.	Engineering Standards. Committee Standard Sections	270
237.	General Electric Co. (U.S.A.) Rail Bond; Section through Bond, showing Effect of Compression	273
238.	General Electric Co. Type of Bond, Protected by Fishplate	274
239.	General Electric Co. Type of Bond under Sole of Rail	274
240.	General Electric Co. Bond outside Fishplate	274
241.	Rail Bonding Press	274
242.	Forest City Electric Co.'s Protected Bond	275
243.	Protected Type Rail Bond under Fishplate	276
244.	Protected Type of Bonds on London Underground Electric Railways	276
245.	Protected Type of Bond on London Underground Electric Railways	276
246.	Chicago Rail Bond	277
247.	Crown Rail Bond	277
248.	Columbia Rail Bond	277
249.	Thomas' Soldered Rail Bonds	278
250.	Shawmut Soldered Rail Bond	278
251.	Arrangement of Track Boosters for Alternating Currents	284

PART III

THE ROLLING STOCK

252.	Electric Locomotive for New York Central Railroad. Weight, 85 Metric Tons	291
253.	Electric Locomotive for New York Central Railroad. Weight, 85 Metric Tons	292
254.	Assembly of Truck of New York Central Locomotive	294
255.	Motor Armature of New York Central Locomotive	295
256.	Sectional View of Air Compressor for New York Central Locomotive	296
257.	Third Rail Shoe of New York Central Locomotive	297
258.	Overhead Contact Device of New York Central Locomotive	297
259.	Characteristic Curves of New York Central Locomotive	298
260.	Curves of Current Input, Voltage and Speed of New York Central Locomotive with Eight-Car Train	299
261.	Curves of Current Input, Voltage and Speed of New York Central Locomotive with Four-Car Train	299
262.	New York Central Locomotive hauling a Six-car Train during one of the Tests of November, 1904	300
263.	Profile of Alignment and Grades of New York Central Experimental Track	301
264.	Diagram of Governing Dimensions and Weights of New York Central Steam and Electric Locomotives employed in Tests made April 29th, 1905	302
265.	Acceleration and Speed-time Curves for Run D of New York Central Locomotive Tests	305
266.	Acceleration Test on New York Central Electric Locomotive hauling a Train of Eleven Cars	306
267.	Speed Run of New York Central Electric Locomotive hauling a Train of Eleven Cars	306
268.	Baltimore and Ohio 1896 Gearless Six-pole Locomotive. Complete Weight, 87 Metric Tons	308
268A.	Truck of Baltimore and Ohio 1896 Gearless Locomotive, showing Motor in Place	309
269.	One Component of 1903 Baltimore and Ohio Locomotive	310
270.	Baltimore and Ohio Two-unit 1903 Locomotive, with Geared Four-pole Motors, Weight of Two-unit Combination, 146 Tons	311
271.	Interior of One-unit of Baltimore and Ohio 1903 Electric Locomotive	312

LIST OF ILLUSTRATIONS

FIG.	PAGE
272. Frame of One-unit of Baltimore and Ohio 1903 Electric Locomotive	313
273. Character Curves of Baltimore and Ohio 1903 Geared Two-unit Locomotive	315
274. Method of mounting Armature on Axle of City and South London Railway Gearless Locomotive	316
275. City and South London Gearless Locomotive	316
276. Central London Railway Gearless Locomotive	318
277. 49 Metric-ton Paris-Orleans Geared Electric Locomotive	320
278. Paris-Orleans Geared Electric Locomotive	321
279. Characteristic Curves of Paris-Orleans Locomotive with 4:1 Gear Ratio	322
280. Characteristic Curves of Paris-Orleans Electric Locomotives with 2:23 Gear Ratio	323
281. "Baggage-car." Type of Paris-Orleans Electric Locomotive	324
282. Early Type of Valtellina Three-Phase Gearless Locomotive	327
283. Early Type of Valtellina (Gearless) Locomotive	<i>To face</i> 328
284. Early Type of Valtellina (Gearless) Locomotive	<i>To face</i> 328
285. Early Type of Valtellina (Gearless) Locomotive	328
286. Early Type of Valtellina (Gearless) Locomotive	329
287. "1904" Type of Valtellina Locomotive	330
288. "1904" Type Valtellina Three-Phase Electric Locomotive	331
289. "1904" Type Valtellina Three-Phase Electric Locomotive	332
290. "1904" Type Valtellina Three-Phase Electric Locomotive	333
291. "1904" Type Valtellina Three-Phase Electric Locomotive	333
292. "1904" Type Valtellina Three-Phase Electric Locomotive	334
293. Trolley for "1904" Type Valtellina Three-Phase Electric Locomotive	335
294. Interior of Driver's Cab of "1904" Valtellina Locomotive	336
295. Electrical Connections of "1904" Type Valtellina Three-Phase Electric Locomotive	<i>To face</i> 336
296. Communicating Bearing between Crank and Connecting Rod on "1904" Type Valtellina Three-Phase Locomotive	337
297. One of the Cascade Motor Sets of the "1904" Type Valtellina Three-Phase Electric Locomotive	337
298. Outline Drawings of one of the Cascade Motor Sets of the "1904" Type Valtellina Three-Phase Electric Locomotive	<i>To face</i> 336
299. Showing Slip Rings of Motor of "1904" Type Valtellina Three-Phase Electric Locomotive	338
300. Diagram of Pneumatic Control Connections for the Water Rheostat Type of Valtellina "1904" Three-Phase Locomotive	339
301. Diagram of Pneumatic Control Connections for the Metallic Rheostat Type of Valtellina "1904" Three-Phase Locomotive	340
302. Motor-driven Air Compressor for the "1904" Type Valtellina Three-Phase Electric Locomotive	341
303. Motor Car of the Valtellina Railway, Equipped with Four Polyphase Motors	342
304. Three-Phase Motor mounted on Axle of Valtellina Motor Carriage	343
305. Elastic Coupling between Wheel and Motor of Valtellina Motor Carriage	344
306. One of the Bogie Trucks of a Valtellina Motor Carriage, with Three-Phase Motors	345
307. Oerlikon 15,000-volt 15-Cycle Locomotive, equipped with Single-Phase Commutator Motors	345
308. Oerlikon 15,000-volt 15-Cycle Locomotive, equipped with Single-Phase Commutator Motors	346
309. Outline Drawings of 200 Kilovolt Ampere Air Blast Transformer, of which two are installed on the Oerlikon 15,000-volt 15-Cycle Locomotive with Single-Phase Commutator Motors (Dimensions in Millimetres)	347
310. 200 h.-p. Single-Phase Commutator Motor with Reversing Poles as Installed on the 15,000-volt 15-Cycle Oerlikon Locomotive	348
311. 200 h.-p. Single-Phase Commutator Motor with Reversing Poles, as Installed on the 15,000-volt 15-Cycle Oerlikon Locomotive	349
312. Diagram of Principles of Operation of 200 h.-p. Single-phase Interpole Commutator Motors of the Type Employed on the Oerlikon 15,000-volt 15-Cycle Locomotive	349
313. Connection Diagram of Wiring of Oerlikon 15,000-volt 15-Cycle Locomotive with Single-Phase Commutator Motors	350

LIST OF ILLUSTRATIONS

FIG.	PAGE
314. Characteristic Curves of Oerlikon 200 h.-p. Single-Phase Commutator Motor (Current Constant at 200 Amperes)	350
315. Characteristic Curves of Oerlikon 200 h.-p. Single-Phase Commutator Motor (Speed Constant at 650 R.P.M.)	350
316. Oerlikon High-Voltage Single-Phase Locomotive of the Motor Generator Type	351
317. High-Voltage Single-Phase Motor Generator Type Oerlikon Locomotive	352
318. Oerlikon Trolley	352
319. Oerlikon Trolley	353
320. Oerlikon Trolley	353
321. Oerlikon Trolley	354
322. Oerlikon Overhead High Tension Switch	355
323. Siemens and Halske High-speed Locomotive, with 10,000-volt Three-Phase Motors	356
324. Siemens and Halske High-speed Locomotive, with 10,000-volt Three-Phase Motors	357
325. Characteristic Curves of 10,000-volt Motors of the Siemens and Halske Locomotive	358
326. Siemens and Halske 10,000-volt Three-Phase Motor	358
327. Siemens and Halske 10,000-volt Three-Phase Motor	359
328. Siemens and Halske 10,000-volt Three-Phase Motor	359
329. Stator of 10,000-volt Siemens and Halske Three-Phase Motor	360
330. Siemens and Halske 10,000-volt Three-Phase Motor	360
331. Diagram of Electrical Connections of Siemens and Halske 10,000-volt Three-Phase Locomotive	361
332. Siemens and Halske High-speed Zossen Motor Car	<i>To face</i>
333. Siemens and Halske High-speed Zossen Motor Car	361
334. A.E.G. High-speed Motor Car	362
335. Allgemeine Electricitäts-Gesellschaft High-speed Motor Car used in Berlin Zossen Trials	363
336. S. & H. Motor for High-speed Zossen Motor Car	364
337. A.E.G. Motor for High-speed Zossen Motor Car	365
338. Spring Supporting Gear for A.E.G. Motor	365
339. Rotor of Motor of S. & H. Zossen Motor Car	365
340. Rotor of Motor of A.E.G. Zossen Motor Car	366
341. Rotor of Motor of A.E.G. Zossen Car in Place on Axle	366
342. Stator Core and Secondary Winding of Motor of Siemens and Halske Zossen Motor Car	366
343. Assembled Motor of A.E.G. High-speed Zossen Motor Car	367
344. Method of Suspending Carriage of Langen Mono-rail System	367
345. Transverse and Longitudinal Sections of the Langen Mono-rail Carriages at Elberfeld	368
346. A Terminal Station of a Langen Mono-rail System	368
347. Langen Mono-rail Carriage for 85 Passengers, as proposed for Berlin. (Length between Buffers, 52 ft. 6 in.)	369
348. Designs of Langen Mono-rail System over a River	370
349. Designs of Langen Mono-rail System over a Street	370
350. Supporting Structure for the Berlin Project for a Langen Mono-rail System (Scale, 1:50)	371
351. Curves showing Variation of Weight Coefficient of Railway Motors, with Speed in Revolutions per Minute	373
352. Curves showing Variation of the Total Weight of Railway Motors, with Speed and Revolutions per Minute	374
353. Curve showing relation of Weight of Motor in Metric Tons to $D^2\gamma g$ of Armature for Continuous Current Railway Motors	376
354. Curves showing Values of Gross Core Length of Armature for various Weights of Motors and Diameters of Driving Wheels. (See Table CXI.)	377
355. Curves for Gearless Motors, showing Overall Length of Motor Frame for various Motor Weights and Diameters of Driving Wheels. (See Table CXII.)	379
356. Curves for Geared Motors, showing Overall Length of Motor Frame for various Motor Weights and Diameters of Driving Wheels. (See Table CXIII.)	380
357. Curves showing Limiting Lowest Speeds of 75 h.-p., 150 h.-p., and 300 h.-p. Geared and Gearless Motors for various Diameters of Driving Wheels	381

LIST OF ILLUSTRATIONS

FIG.		PAGE
358.	Limiting Values of Motor Speed (r.p.m.) for Different Train Speeds (Miles per Hour) for Motors of 75, 150, and 300 h.-p. <i>To face</i>	384
359.	Curves showing Relation between Speed of Locomotive and Driving Wheel Diameter, Motor Speed, and Weight	387
360.	Diagram of Repulsion Type Single-Phase Motor	393
361.	Diagrams of the Latour-Winter-Eichberg Type of Single-Phase Commutator Motor	394
362.	Compensated Series Type of Single-Phase Commutator Motor	396
363.	Assembly of British Thomson-Houston Co.'s Compensated Series Single-Phase Railway Motor	396
364.	Assembly of British Thomson-Houston Co.'s Compensated Series Single-Phase Railway Motor	397
365.	Field for British Thomson-Houston Co.'s Compensated Series Single-Phase Railway Motor	397
366.	Parts of British Thomson-Houston Co.'s Compensated Series Single-Phase Railway Motor	398
367.	Assembly Drawing giving the Main Dimensions of British Thomson-Houston Co.'s 75 h.-p. Single-Phase Compensated Series Type Railway Motor	398
368.	G.E.A. 605 Railway Motor. Characteristic Curves on 250-volt Alternating-Current Circuit, 25 Cycles. Efficiency corrected for a Copper Temperature of 75° Cent. 33-inch Wheels 73/17 Gear. (British Thomson-Houston Co.)	400
369.	G.E.A. 605 Railway Motor. Characteristic Curves on 250-volt Continuous-current Circuit. Efficiency Corrected for a Copper Temperature of 75° Cent. 33-inch Wheels 73/17 Gear (British Thomson-Houston Co.)	401
370.	Car Wiring for T—33 A. Controllers with Four G.E.A. 605 Compensated Motors for A.C. Operation (British Thomson-Houston Co.)	402
371.	British Thomson-Houston Co.'s Latest Form of Oil-Cooled Compensator, as Employed in Single-Phase Railway System	402
372.	Diagram of Connections of British Thomson-Houston Co.'s Single-Phase Railway System as arranged for the Multiple-Unit System of Control	403
373.	Diagram of British Westinghouse Electric and Manufacturing Co.'s Single-Phase Series Motor, with Forced Neutralising Winding, and showing Normal Distribution of Magnetic Flux	403
374.	Characteristic Curves of British Westinghouse Electric and Manufacturing Co.'s Standard Single-Phase Railway Motor	404
375.	British Westinghouse Electric and Manufacturing Co.'s Single-Phase Motors and Control Equipment Connections for Working on Alternating-Current or Continuous-Current Circuits	405
376.	British Westinghouse Electric and Manufacturing Co.'s Wiring Diagram for a Motor Coach equipped with Single-Phase Series Motors and Electro-Pneumatic Multiple-Unit Control System	406
377.	Armature of British Westinghouse Electric and Manufacturing Co.'s 150 h.-p. Single-Phase Railway Motor	407
378.	Outline Drawing of 150 h.-p. Single-Phase Series Wound Railway Motors, as manufactured by the British Westinghouse Electric and Manufacturing Co. <i>To face</i>	408
379.	Field Frame of British Westinghouse Co.'s 150 h.-p. Single-Phase Railway Motor with the Neutralising Windings only in Place	408
380.	Field Frame of British Westinghouse Co.'s 150 h.-p. Single-Phase Railway Motor with both the Neutralising Windings and the Magnetising Coils in Place	409
381.	Diagram, showing Relative Electrical Connections between Auto-Transformer and Preventive Coil and Voltages applied to Motors for the several Positions of Master Controller (British Westinghouse Electric and Manufacturing Co.)	409
382.	Diagram, showing Distribution of Current with Controller in Second Position (British Westinghouse Electric and Manufacturing Co.)	410
383.	Diagram, showing Distribution of Current with Controller in Transition from Second to Third Position (British Westinghouse Electric and Manufacturing Co.)	410
384.	Photograph of the High-tension End of an Air-Blast Type of Auto-Transformer, as employed in the British Westinghouse Co.'s Single-Phase Railway System	410

LIST OF ILLUSTRATIONS

FIG.	PAGE
385. Outline Drawing of Oil-insulated Auto-Transformer by the British Westinghouse Electric and Manufacturing Co.	412
386. Electro-pneumatically-controlled Unit Switches, as employed in the British Westinghouse Co.'s Single-phase Railway System	412
387. British Westinghouse Co.'s Self-Reversing Pantograph Trolley	413
388. British Westinghouse Co.'s Self-Reversing Pantograph Trolley	413
389. British Westinghouse Co.'s Exhibition Car at Trafford Park, Manchester	414
390. Some Characteristic Curves of Single-Phase Commutator Motors (Full Line Curves) and Continuous Current Motors (Broken Line Curves).	<i>To face</i> 416
391. Efficiency Curves of Latour-Winter-Eichberg Motor	417
392. Calculated Curve of 175 h.-p. Repulsion Motor at 1,500 Volts	418
393 and 394. Comparison of Efficiencies of Continuous-Current and Single-Phase Motors	422
395. Diagram for Continuous-Current 2-mile Run	424
396. Diagram for Single-Phase 2-mile Run	424
396A. Plan Outlines of Motor Carriages and Trailers	<i>To face</i> 424
397. Paris-Metropolitan Motor Car with Rigid Wheel Base	430
398. Truck of Paris-Metropolitan Motor Car with Rigid Wheel Base	431
399. Goods Locomotive of North-Eastern Railway	432
400. Mr. Worsdell's Design for the Bogies for the Electric Motor Cars for the North-Eastern Railway. General Arrangement of Motor Truck (Brush Electrical Engineering Co., Ltd.)	<i>To face</i> 432
401. Type of Bogie Truck as employed for Passenger Coaches on American Steam Railways	433
402. General Arrangement of Motor Bogie in Hay's Design for the Bogies for the Electric Motor Carriages of the Lancashire and Yorkshire Railway	<i>To face</i> 434
403. General Assembly of Motor Truck for the Motor Carriages of the Manhattan Elevated Railway	436
404. Truck for Central London Railway Geared Locomotive	437
405 and 406. District Railway Trailer Trucks	438
407. District Railway Motor Car Truck	439
408. Central London Railway: General Arrangement of Motor Bogie	<i>To face</i> 440
409. Hedley's Heavy Service Motor Truck used at Chicago	<i>To face</i> 440
410. Cast Steel Trailer Truck	<i>To face</i> 440
411. Central London Railway: Cast Steel Trailer Bogies. General Arrangement of McGuire Truck	440
412. J. G. Brill Company No. 27 E Truck for Brooklyn Heights Elevated Railway. (May 22nd, 1901)	<i>To face</i> 440
413. Brill Truck	441
414. Brill Truck	442
415. Bogie Truck under Trailer End of Central London Railway Carriage	<i>To face</i> 442
416. Motor Truck showing Arrangement of Brakes on Manhattan Railway	447
417 to 419. Standard Brake Heads and Shoes	448
420 and 421. Central London Railway: New Brake Block for Motor Trucks	449
422. Central London Railway: Carriage Axle-Box	<i>To face</i> 450
423. Master Car-builders' Standard Axle-Box for a $4\frac{1}{2}$ " \times 8" Journal	454
424. Korbully Axle-Box	<i>To face</i> 454
425 to 435. Car and Wagon Axles	<i>To face</i> 458
436. Manhattan Wheel	460
437. Tyre Sections (issued 1904).	462

List of Tables

PART I

THE MECHANICS OF ELECTRIC TRACTION

TABLE	PAGE
I. Values of V^5	5
II. Rolling Stock Data	14
III. Equivalent Values of Distance, English and Metric	18
IV. Equivalent Values of Speed, English and Metric	19
V. Comparative Table of Speeds	19
VI. Comparative Table of Speeds	20
VII. Tractive Force and Accelerating Rate	22
VIII. Corresponding Schedule Speeds in Miles per Hour for Runs of following distances between Stops	29
IX. Consumption of Energy at Axles in Watt Hours per Ton Mile, one Stop per Mile	43
X. Average Power at Axles in Kilowatts per Ton, one Stop per Mile	41
XI. For a Run of two Miles between Stops, at an average Speed of 30 Miles per Hour, this Table sets forth the Calculations of the Tractive Force (T. F.), Power and Energy at the Axles per Ton Weight of Train for a 200-Ton Train at various Rates of Acceleration, the Braking giving a Rate of Retardation equal to the Rate of Acceleration	45
XII. Recoverable Energy per Ton Mile in Percentage of Total Energy expended at Axles per two Mile run from Start to Stop and Average Speed of 30 Miles per Hour	46
XIII. Summary of Results given in Table XII.	47
XIV. G.E. 66 A. Railway Motor at 500 Volts. Ratio of Gearing = 3.94. Diameter of Car Wheels = 34 ins.	57
XV. Four G.E. 66 A. Railway Motors. Ratio of Gearing = 3.94. Diameter of Car Wheels = 34 ins. All four Motors in Parallel	59
XVI. Four G.E. 66 A. Railway Motors. Ratio of Gearing = 3.94. Diameter of Car Wheels = 34 ins. All four Motors in Parallel	60
XVII. Controller positions for four G.E. 66 A. Motors. Mean Acceleration = 1 Mile per Hour per Second. Speed = 13.4 Miles per Hour	65
XVIII. Distance covered during each Operation for Run of one Mile	67
XIX. Nett Energy at Car Wheel. Mean Rate of Acceleration = one Mile per Hour per Second	69
XX. Comparison of five Alternative Methods of Motor Control	75
XXI. Calculations for a Half-mile Run at an Average Speed of 19 Miles per Hour. 120-Ton Train. Level Track	77
XXII. Comparison of Results of Half-mile Runs with various Periods of Coasting. Acceleration = one Mile per Hour per Second in all cases. 120-Ton Train. Level Track	79
XXIII. Comparison of Results of Half-mile Runs at an average Speed of 19 Miles per Hour, and with various Periods of Coasting. 120-Ton Train. Level Track. Varying Rates of Acceleration	79
XXIV. Calculations for Operation of a 120-Ton Train at an average Speed of 19 Miles per Hour over a Half-Mile Section with a 2.73 per cent. down Gradient for the first 300 ft., and a 2.73 per cent. up Gradient for the last 300 ft.	81
XXV. Schedule of Gradients on the various Sections of the Railway	84
XXVI. Continuous Current Motor Equipments Employed on a Number of Typical Railways	88

LIST OF TABLES

TABLE	PAGE
XXVII. Schedule Speed with 15 Second Stops, for a Mean Acceleration of 1.5 Miles per Hour Per Second, and a Mean Retardation of 1.5 Miles per Hour per Second, when the Maximum Speed does not exceed the Average Speed from Start to Stop by more than 33 $\frac{1}{3}$ per cent	91
XXVIII. Armstrong's Data for average Input to Train under various Conditions of Service	91
XXIX. Representative Data of Trains for various Services	94
XXX. Watt-Hours Input to Trains for various Services per Seat Mile	94
XXXI. Watt-Hours Input to Trains for various Services per Seat Mile	94
XXXII. Dependence of Energy Consumption on Schedule Speed	95
XXXIII. Comparison of Input per Seat Mile with Continuous Current and Single-Phase Equipments	96
XXXIV. Further Comparisons of Input with Continuous Current and Single-Phase Equipments	96
XXXV. Comparison of Schedule Speeds with Continuous Current and Single-Phase Equipments	96

PART II

THE GENERATION AND TRANSMISSION OF THE ELECTRICAL ENERGY

XXXVa. Schedule of Type and Capacity of Plant Installed at the Central London Railway Generating Station	119
XXXVb. Schedule of Type and Capacity of Plant Installed at the Generating Station of the Glasgow Corporation Tramways	122
XXXVc. Schedule of Type and Capacity of Plant Installed at the British Tramways Generating Station	126
XXXVd. Schedule of Type and Capacity of Plant Installed at the Generating Station of the Dublin United Tramways Co.	130
XXXVI. Operating Costs of Electrical Power Generating Stations	133
XXXVII. Annual Overall Efficiencies of Three Electrical Power Generating Stations	134
XXXVIII. Annual Overall Efficiencies of Twenty-six Electrical Generating Stations	136
XXXIX. Annual Overall Efficiencies of English and Foreign Electrical Generating Stations	134
XL. Table of Thermal Efficiency of Engine and Generator and Overall Efficiency of Complete Plant on Steady Load	138
XLl. Table of Overall Efficiencies of Steam Plants under Service Conditions	139
XLII. Data of Cables for Various Voltages <i>To face</i>	142
XLIII. British Standard Sizes of Stranded Conductors for Electric Supply	147
XLIV. Maximum Permissible Current in Copper Conductors according to the Rules of the Institution of Electrical Engineers	148
XLV. Current Densities in Copper Wires Employed in Cables for 1,000 Volts and over, according to the Rules of the German Society of Electricians	149
XLVI. Particulars of Central London Railway High Tension Cables	157
XLVII. Dielectric Capacity of Central London Railway Cables	158
XLVIII. Weights and Dimensions of Central London Railway High Tension Cables	158
XLIX. Particulars of London Underground Railways High Tension Cables	159
L. Engineering Standards Committee's Table of Thicknesses of Insulation for Paper-Insulated Concentric Cables for Pressures exceeding 2,200 Volts	162
LI. Engineering Standards Committee's Table of Thicknesses of Insulation for Paper-Insulated Three-Core Cables for Pressures exceeding 2,200 Volts	163
LII. Engineering Standards Committee's Table of Thicknesses of Insulation for Rubber-Insulated Concentric Underground Cables for Pressures exceeding 660 Volts	163
LIII. Engineering Standards Committee's Table of Thicknesses of Insulation for Rubber-Insulated Three-Core Underground Cables for Pressures exceeding 660 Volts	164
LIV. Resistances and Weights of Copper Conductors of various Sizes	167
LV. Inductances and Reactances of Copper Conductors	167

LIST OF TABLES

TABLE	PAGE
LVI. Capacities and Charging Currents of Copper Conductors	168
LVII. Data of 600-K.W. Rotary Converter	177
LVIII. Amperes Input to Rotary Converter with Varying Field Excitation, at Full Load Output	178
lix. Amperes Input to Rotary Converter with Varying Field Excitation for various Outputs	179
LX. Adjustment with 64 per cent. Compounding at Full Load, and for Unity Power Factor at 75 per cent. of Full Load	179
LXI. Rotary Converter adjusted for Unity Power Factor at Three-quarter Load and 64 per cent. Compounding at Full Load	180
LXII. Variation in Rotary Converter Voltage with Varying Load	182
LXIII. 64 per cent. Compounding at Full Load, Adjustment for Unity Power Factor at Three-quarter Load	182
LXIV. Rotary Converter adjusted for Unity Power Factor at Three-quarter Load and 36 per cent. Compounding at Full Load	183
LXV. 36 per cent. Compounding at Full Load, Adjustment for Unity Power Factor at Three-quarter Load	184
LXVI. Rotary Converter with Shunt Excitation	185
LXVII. Shunt Excitation and a Resistance of 0.02 Ohm per Phase	185
LXVIII. Some Data of a Rotary Converter Installation	188
LXIX. Distribution of Current in Rotary Converter and Battery for a Period of Five Minutes	197
LXIXA. Cost of Battery-Booster Sets, including the Battery and Booster and Switch Gear complete and ready for work, but excluding the Battery House—One-hour Discharge Rate	202
LXIXB. Cost of Battery-Booster Sets, including the Battery and Booster and Switch Gear complete and ready for work, but excluding the cost of the Battery House—Three-hours Discharge Rate	203
LXX. Number of Sub-stations on various Electric Railways and their Capacity	209
LXXI. List of Sub-stations on various Electric Railways and Data regarding their Equipment	209
LXXII. Floor Space of various Electric Sub-stations	211
LXXIII. Composition and Conductivity of Conductor Rails	248
LXXIIIa. Showing Spacing of Insulating Supports	249
LXXIV. Particulars of Conductor Rails for various Railways	249
LXXV. Particulars of Conductor Rails for various Railways	256
LXXVI. Table of Span and Dip of Suspension Cables	260
LXXVII. Particulars of Standard Track Rails	272
LXXVIII. Particulars of Track Rails of various Railways	272
LXXIX. Resistances of Rail Bonds	279
LXXX. Comparison of Resistances of various Rail Bonds, not including in any case the Resistance of the Rail	279
LXXXI. Particulars of Rail Bonds on various Railways	280
LXXXII. Resistance, Reactance and Impedance per mile of Bull Head Rails. Standard Section, 25 cycles per second	282
LXXXIII. Resistance, Reactance and Impedance per mile of Bull Head Rails. Standard Section, 20 cycles per second	282
LXXXIV. Resistance, Reactance and Impedance per mile of Bull Headed Steel Rails. Standard Section, 15 cycles per second	283
LXXXV. Impedance of Rail portion of Circuit	283
LXXXVI. Impedance of Overhead Conductor	284
LXXXVII. Total Impedance per Mile of Circuit	285
LXXXVIII. Table of Current Values in Track Rails for 10 Volts Difference of Potential between ends of Rail for 100 lb. Rail	286
LXXXIX. Table of Pressure Differences on Track Rails with 100 Amperes in Rail—100 lb. Rail	287

LIST OF TABLES

PART III

THE ROLLING STOCK

TABLE	PAGE
XC. Leading Data of New York Central Electric Locomotive	293
XCI. Weight of Electrical Equipment of New York Central Locomotive	293
XCII. Composition of Trains in New York Central Tests of April, 1905	303
XCIII. Average Voltage at Live Rail during Acceleration	303
XCIV. Comparison of Steam and Electric Locomotives on New York Central Railway	305
XCv. Leading Data of Baltimore and Ohio 1896 Gearless Locomotive	308
XCVI. Principal Dimensions of Baltimore and Ohio 1903 Geared Two-unit Locomotive	313
XCvII. Weight of Electrical Equipment of Baltimore and Ohio 1903 Geared Two-unit Locomotive	314
XCvIII. Detailed Weights of Gearless Central London Railway Locomotive	317
XCIX. Gearless Central London Locomotive Weights, Exclusive of Electrical Equipment	319
C. Weights of Electrical Equipment of Gearless Central London Locomotive	319
CI. Principal Data of Paris-Orleans Geared Electric Locomotives	321
CII. Weights of Electrical Equipment of Paris-Orleans Geared Electric Locomotives	323
CIII. Data of Paris-Orleans Rolling Stock	324
CIV. Comparison of Steam Locomotive with Gearless Bi-polar Electric Locomotive	325
CV. Itemised Weights of Oerlikon 15,000-volt Fifteen-cycle Locomotive, with Single-Phase Commutator Motors	348
CVI. Principal Data of a Carriage of the Langen Mono-rail System	371
CVII. Weight Coefficients of Continuous Current Railway Motors	374
CVIII. Total Weights of Continuous Current Railway Motors, exclusive of Gearing	374
CIX. Valatin's Data for Railway Motors	375
CX. Values of $1^2\lambda g$ for Continuous Current Railway Motors	376
CXI. Gross Length of Core in Centimetres (λg) of Motors of various Weights, for Driving Wheels of various Diameters, taking $D = 0.5 \times$ Diameter of Driving Wheel	377
CXII. Overall Length of Frame, in Inches, of Gearless Motors of various Weights for Driving Wheels of various Diameters	378
CXIII. Overall Length of Frame, in Inches, of Geared Motors of various Weights for Driving Wheels of various Diameters	379
CXIV. Speeds of 75 h.-p. Motor for various Locomotive Speeds in Miles per Hour and various Driving Wheel Diameters	382
CXV. Speeds of 150 h.-p. Motor for various Locomotive Speeds in Miles per Hour and various Driving Wheel Diameters	383
CXVI. Speeds of 300 h.-p. Motor for various Locomotive Speeds in Miles per Hour and various Driving Wheel Diameters	384
CXVII. Showing Particulars of Motors for the Mean Points in Fig. 358	385
CXVIII. Data for Weights of Locomotives and Motor Equipments	386
CXIX. Weight of Single-Phase and Continuous Current Motors	389
CXX. Showing the Seating Capacity per Square Foot of Coaches used on various Railways	429
CXXI. Journal Pressures	458
CXXII. Various Qualities of Steel for Axles	460
CXXIII. Qualities of Steel for Tyres	463

Part I

THE MECHANICS OF ELECTRIC TRACTION

ELECTRIC RAILWAY ENGINEERING

Chapter I

TRACTIVE RESISTANCE AT CONSTANT SPEED

THERE is a general impression that the subject of tractive resistance on rails is but little understood. Although this is to a certain extent the case so far as relates to an analysis of the various physical causes of resistance to motion on rails, there is now fairly general agreement as to the amount of the total tractive resistance at various constant speeds on a modern well-built surface railway on a calm day on a straight track. While there are minds to which an indefiniteness of the nature of 30 per cent. presents itself as a hopeless impediment, there appears to be no justification for this attitude so far as relates to tractive resistance on rails. It is true that the degree of wetness or dryness of the rail, the velocity of the wind, the contour of the train and its mechanical design, and the character of the permanent way, all introduce considerable variations. The engineer will not disregard these influences; indeed, each of these influences will, in a given case, require careful study. But, so far as relates to preliminary estimates of the average power required at the axles, the most elaborate recent experimental data obtained in different countries and under varied conditions, converge toward sufficiently definite values.

As a matter of fact, even were the latest experimental data for tractive resistance at various constant speeds widely divergent, no considerable uncertainty would be introduced into the results, except for the case of long runs between stops. For runs of lengths up to a mile or two at high schedule speeds, the energy consumed during the accelerating interval is so considerable a percentage of the total energy consumption, as to mask very great inaccuracies in the data of tractive resistance at constant speed. The calculation of the energy consumed during the accelerating interval is much more independent of assumptions based on experimental data. The shorter the run between stops, the greater is the importance of accuracy in estimations affecting the acceleration values, while the estimations of the frictional resistance are of comparatively little account. The longer the run between stops the more important does it become to base the estimations upon fairly correct data of tractive resistance.

ELECTRIC RAILWAY ENGINEERING

Tractive Resistance at Starting.

The tractive resistance at starting on a level is very dependent upon the type and design of the bearings, the wheel diameter, and the design and condition of the permanent way. Aspinall's value of 17 lbs. per ton is a fair average figure for the best conditions obtaining on main lines with medium and heavy trains. On the Central London Tube Railway the starting resistance on the level is 20 lbs. per ton for a 113-ton train comprising seven cars. On the City and South London Tube Railway, McMahon's experiments showed on occasions a starting resistance of 40 lbs. per ton for 26-ton trains.¹ This value is rarely exceeded, even on urban tramway lines.

Tractive Resistance at Constant Speed.

For very low speed, the tractive resistance decreases with increasing speed, reaching a minimum at some 5 miles per hour. The speed corresponding to

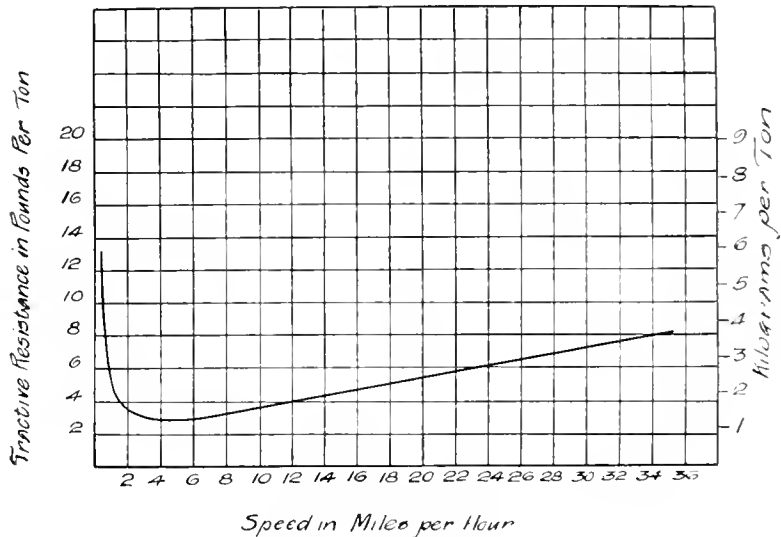

Fig. 1. CURVES OF TRACTIVE RESISTANCE AT LOW SPEEDS FOR AN 83-TON 75-FOOT CAR, AS DEDUCED FROM THE BERLIN-ZOSSEN TESTS.

the minimum tractive resistance is, however, a very variable quantity, and is very dependent upon the construction and condition of the permanent way and of the rolling stock. For good conditions, the minimum tractive resistance may be as low as 3 lbs. per ton. In the case of the 83-ton cars employed for the

¹ "The curve showed the variation in the draw-bar pull, its high value at the start, about 40 lbs. per ton, dropping to the minimum of 9 lbs. per ton. . . . The most striking feature of it, was the high resistance at starting, and, in order to test that, an experiment had been made with the train in a siding, a spring balance being used to start it very slowly; the resistance in that case had been found to be 20 lbs. to 25 lbs. per ton. A similar experiment on a locomotive had shown the resistance to be 25 lbs. to 30 lbs. per ton, but the first test when the locomotive was standing had always given a higher result, and that seemed to be due to the squeezing out of the oil."—McMahon. "Proceedings of the Institution of Civil Engineers" (1901). Vol. CXLVII., p. 213.

Moreover, McMahon's wheel diameters were but 24 ins. For McMahon's results, see also Curve A of Fig. 6, on p. 9.

TRACTION RESISTANCE AT CONSTANT SPEED

Berlin-Zossen tests, the minimum resistance amounted to a little less than 3 lbs. per ton, as may be seen from the curve of Fig. 1, relating to the results obtained at low speeds. The two cars with which most of the tests were made, weighed 90 tons (A.E.G. Car) and 77 tons (S. and H. Car) respectively. For our purposes the mean value of 83 tons is taken.

For electric traction, however, but little interest attaches to the traction resistance at speeds of less than 10 miles per hour. From 10 miles to 100 miles per hour the following formula, due to Aspinall, leads to very trustworthy results:—

$$R = 2.5 + \frac{V^{\frac{5}{3}}}{51 + 0.028 L}$$

R = traction resistance in pounds per (metric) ton (of 2,200 lbs. or 1,000 kgs.).

V = speed in miles per hour.

L = length of train in feet.

The formula, owing to the fractional exponential power of V, is an inconvenient one to use, and hence Table I. has been prepared, in which values of $V^{\frac{5}{3}}$ are given.

TABLE I.—*Values of* $V^{\frac{5}{3}}$.

V Speed in Miles per Hour.	$V^{\frac{5}{3}}$
10	46.8
15	91.5
20	151
25	214
30	295
40	473
50	676
60	933
70	1,180
80	1,510
90	1,820
100	2,160
120	2,820

The curves of Fig. 2 have been plotted, by means of Aspinall's formula, for train lengths of 100, 1,000, and 2,000 ft., which cover most cases which will occur in heavy electric traction.¹

Now while it is quite true that these results vary from the results of other careful investigations, sometimes by high percentages, this is really of minor importance, on account of numerous other uncontrollable factors. Thus in a heavy wind the train resistance will often be doubled. Variations in the type and condition of the rail,² the condition

¹ "On the New York Central and Hudson River Railroad there were several trains daily of 3,000 tons to 4,000 tons, drawn by American locomotives, the number of cars ranging from seventy-five to ninety."—Dudley, "Proceedings of the Institution of Civil Engineers" (1901), Vol. CXLVII., p. 261.

² "Dr. P. H. Dudley has stated that when he substituted an 80-lb. rail for a worn 65-lb. rail it made a difference of 75 h.-p. to 100 h.-p., and he estimated that a 105-lb. rail saved 200 h.-p. as

ELECTRIC RAILWAY ENGINEERING

of permanent way, type of rolling stock, etc., also introduce great differences in the train resistance, as also the location of the driving power, whether distributed upon the axles of the different vehicles, or concentrated on a locomotive. These and similar considerations lead to the conclusion that the results set forth in the curves of Fig. 2 are amply precise as a mean basis for calculations.

The recent high-speed tests at Zossen, near Berlin, included elaborate

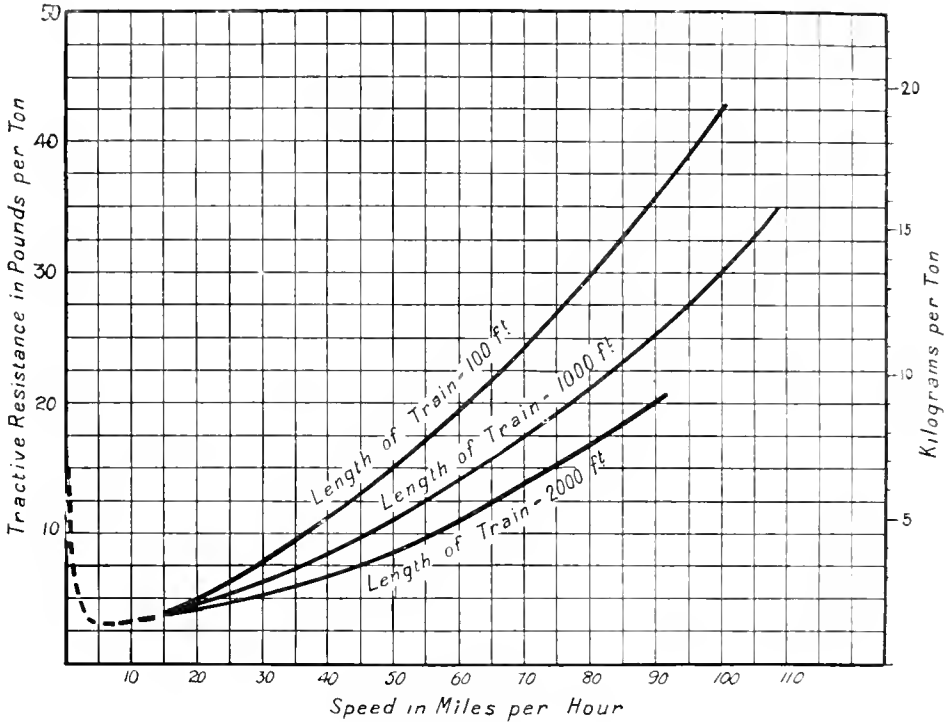

Fig. 2. CURVES OF TRACTIVE RESISTANCE FOR VARIOUS LENGTHS OF TRAIN.

determinations of the tractive resistance. These tests were made upon single coaches of a length of 75 ft. and weighing 83 tons,¹ the design, chiefly on account

compared with the 60-lb. or 65-lb. rail."—Aspinall. "Proceedings of the Institution of Civil Engineers" (1901), Vol. CXLVII, p. 241.

Dr. Dudley did not state the total horse-power, which, of course, would have to be known in order to lend definiteness to his data.

¹ Camp ("Notes on Track," 2nd edition, 1904) gives the following concise *resumé* of some of the leading conditions of the Berlin-Zossen tests:—"During the fall of 1903 some unprecedented speeds were made on the Marienfelde-Zossen military line in Germany, which aroused a world-wide sensation, and the particulars of the track construction and of the rolling stock are interesting in the present connection. The road was 14½ miles long, nearly level, and mostly straight, there being one curve of 52½ minutes (radius 6,562 ft.) near one end. The track was laid with 84½-lb. rails, generally 39·4 ft. long, on fir ties, eighteen to the rail length, with tie plates, six-bolt angle-bar splices 31½ ins. long, with vertical flanges hanging 1½ ins. below base of rail, between joint ties, but some of the joints were of the lap type. The ballast was broken stone. On 10½ miles of the line, guard rails were laid inside the traffic rails to a flangeway of 1·97 ins. These were ordinary T-rails laid on side, with the base (4½ ins. wide) presented for the service side of the guard, the upper edge coming 1¾ ins. above the top of the traction rail. They were supported upon cast-iron chairs, lag-screwed to the ties. With the exception of these guard rails on part of the line which were found to be an

TRACTIVE RESISTANCE AT CONSTANT SPEED

of the great capacity of the motor equipment, thus having the exceptional constant of 1.1 tons weight per foot of overall length.¹ The results obtained from these tests are given in the lower curve of Fig. 3, and the results calculated from Aspinall's formula are given in the upper curve of the same figure. The agreement is seen to be very good. But for this excellent agreement between the Aspinall and the Zossen tests, both of which were most elaborate, the values at the lower speeds would have been pronounced decidedly too low, as all prior formula gave higher

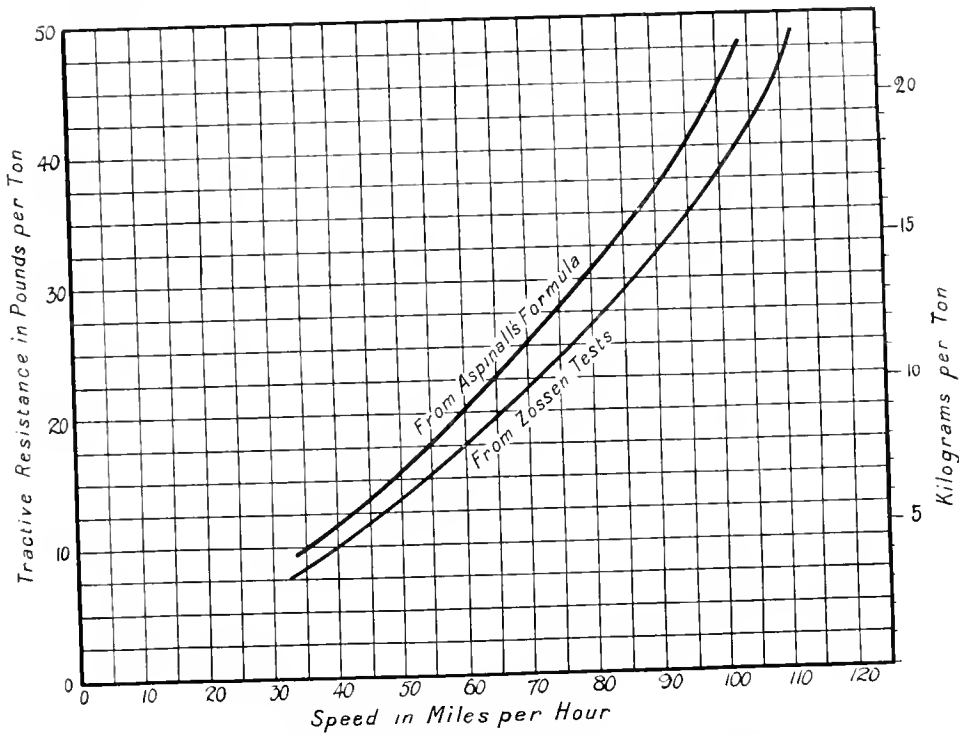

Fig. 3. CURVES OF TRACTIVE RESISTANCE FOR 83-TON 75-FOOT CAR.

results at low speeds. That this is the case is evident from Figs. 4 and 5, taken from Gottshall's "Electric Railway Economics" (pp. 156 and 154).

unnecessary precaution), the track was, as thus to be seen, only of ordinary construction. There were two electric cars, one being used in each of the many experiments. Each car was 72 ft. long, mounted on two six-wheel trucks, wheels 49.2 ins. diameter; wheel base of truck 16.4 ft. long; each truck equipped with two 250-h.-p. motors on the outside axles, and air brakes, with brake shoes on both sides of all wheels; total weight of car, 92 tons. As the experiments continued, the speeds were gradually increased until trips were made repeatedly at 105 to 110 miles per hour, or the whole distance each way in eight minutes. The energy consumed in driving the car at such speeds was about 1,600 h.-p., and stops were made in 6,560 feet from the point where brakes were applied. On October 23rd one of the cars attained a speed of 128½ miles per hour, and on October 28th the other car was run at the tremendous speed of 130½ miles per hour."

In the above quotation the weights in tons have been changed by the writers from the American short ton of 2,000 lbs. employed by Camp, to the metric ton of 2,200 lbs. Camp's weight per car evidently relates to the A.E.G. car.

¹ In present practice on steam and electric railways, the weight of loaded car or train per foot of overall length, rarely exceeds 0.65 tons, and as a rough but representative value 0.5 tons per foot of overall length may be taken. (See also Table II., on p. 14.)

ELECTRIC RAILWAY ENGINEERING

In tube railways, where there is small clearance between the walls and the train, high-tractive resistance (depending partly on the amount of clearance) has been found, and, of course, varying as a function of the speed. In Fig. 6 the full line curves (b and c) are deduced from tests on the Central London Railway (in which the tube's internal diameter is 11 ft. 6 ins.), showing the train resistance as a function of the speed. The minimum clearance between the tube and train is 6 ins.

From measurements made on the City and South London Railway, McMahon obtained the data from which the broken line curve (a) of Fig. 6 has been deduced.

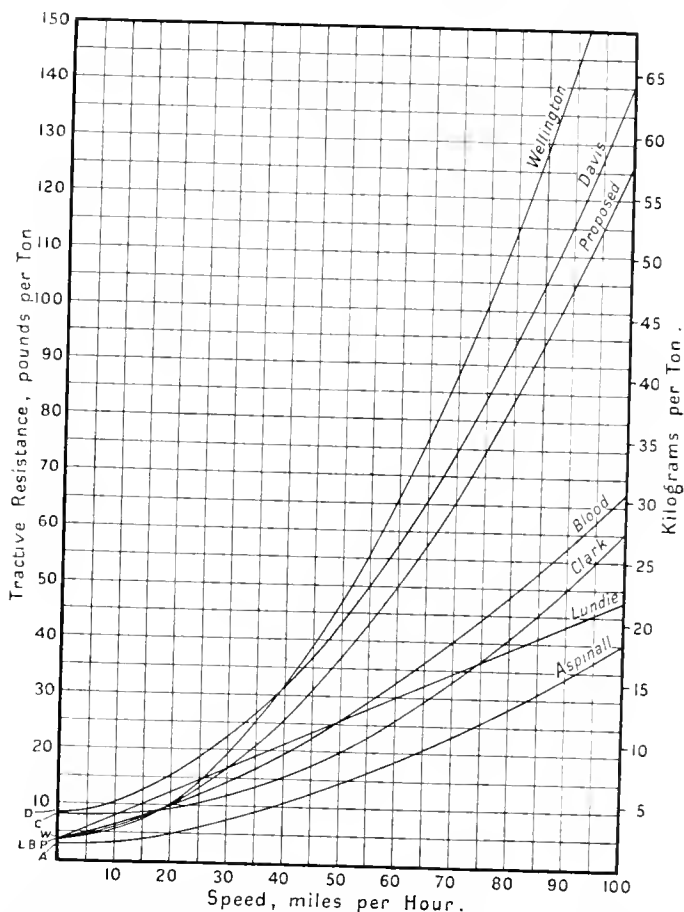

Fig. 4. CURVES FOR TRACTIVE RESISTANCE ACCORDING TO WELL-KNOWN FORMULE.
SINGLE-CAR OPERATION. WEIGHT OF CAR ABOUT 22 TONS.

From the train test curves obtained on the Central London Railway, the total tractive resistance at 30 miles an hour is 1,200 lbs. for a seven-car train, and 600 lbs. for a single car, the weights of the trains being 125 tons and 25 tons respectively. It appears that there is a constant figure of 6 lbs. per ton for journal friction, etc., and a figure for the head and tail resistance which depends upon the speed and is unaffected by the length of the train, the actual equation for the total tractive resistance being—

$$\text{Resistance in pounds per ton} = 6 + 0.5 \frac{V^2}{W}$$

where V is the speed in miles per hour and W is the weight of the train in metric tons.

TRACTION RESISTANCE AT CONSTANT SPEED

In Fig. 7 are two curves, one showing the resistance in pounds per ton for a seven-car Central London train, as worked out by the above formula, and the other showing the resistance of this train on a surface track, as worked out by Aspinall's formula.

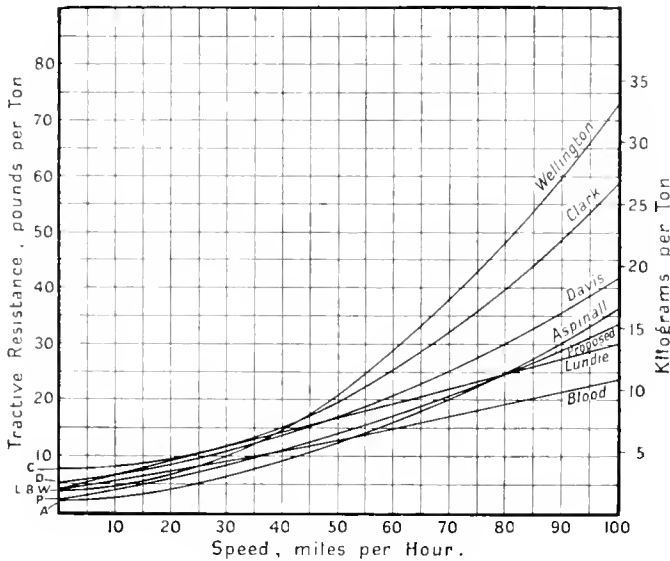

Fig. 5. SAME AS FIG. 4, BUT FOR TRAIN OF FIVE 40-TON CARRIAGES, SAY 200 TONS.

No tests have been made with high-speed service in such tube railways, but the resistance can be reasonably expected to be considerably increased at speeds above, say, 40 miles per hour. Thus from the Zossen tests on an 83-ton car it

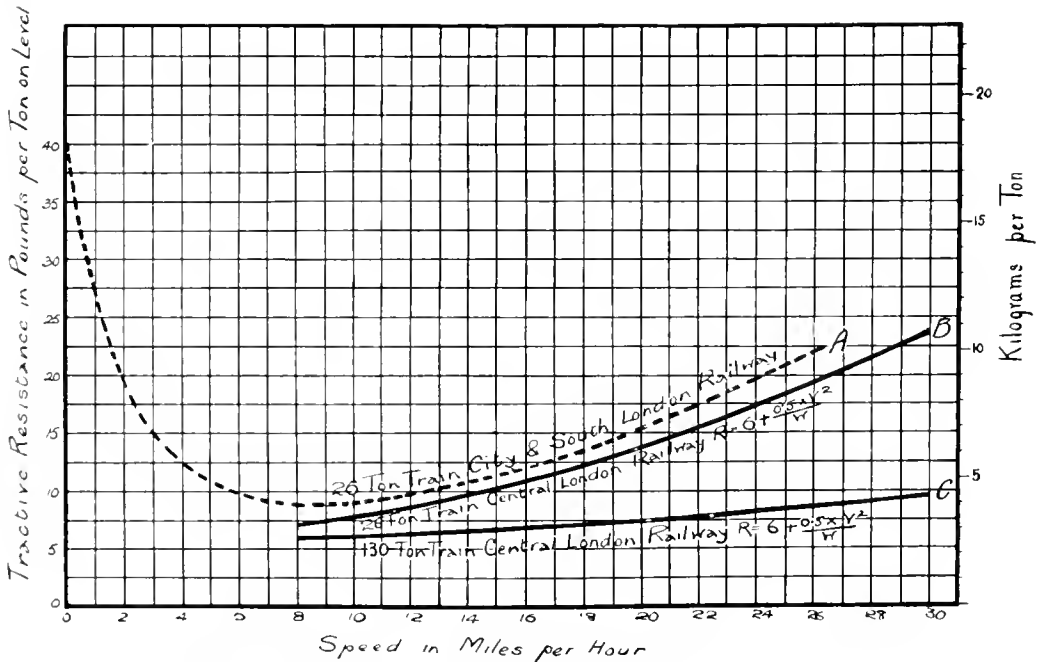

FIG. 6. CURVES OF TRACTIVE RESISTANCE IN TUBE RAILWAYS.

ELECTRIC RAILWAY ENGINEERING

has been found that at a speed of 40 miles per hour the air resistance becomes equal to the mechanical resistance, and at a speed of 100 miles per hour the air resistance on surface roads is four times the mechanical resistance. This is seen from the curves of Fig. 8, in which the curve of total resistance for the Zossen tests is supplemented by two curves of the component resistances due respectively to air resistance and mechanical resistance. The longer the train, however, the less is the percentage which the air resistance constitutes of the total resistance; and for well-vestibled trains of several hundred tons weight, the air resistance would probably not exceed the mechanical resistance below speeds of from 45 to 50 miles per hour. For a five-coach train, Aspinall ("Proceedings of the Institution of Civil Engineers," (1901), Vol. CXLVII., p. 249) estimates the atmospheric resistance as becoming equal

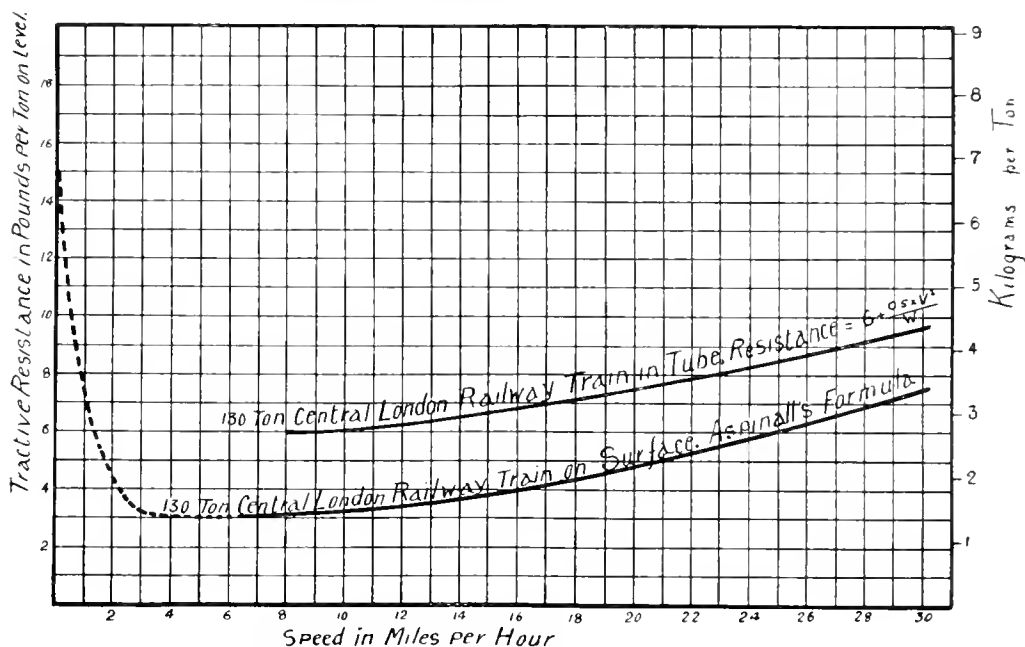

Fig. 7. CURVES OF TRACTIVE RESISTANCE IN TUBE RAILWAYS AND ON SURFACE.

to 50 per cent. of the total resistance at 80 miles per hour. But all his statements relate to the train *behind the engine*, and the engine shields the train from a considerable portion of the air resistance. Thus for a motor-car train, the air resistance would become equal to the mechanical resistances at a much lower speed, and the corresponding speed would be lower the shorter the train.

From such results it is evident that for high-speed work it would be futile to attempt to materially reduce the train resistance by modifications in the design of the rolling stock and permanent way,¹ and that attention should rather be directed to the contour of the train. Not only does the form of the front and rear ends greatly affect

¹ Of course the greatest attention must, nevertheless, be given to the design of the rolling stock and permanent way, in order to render high speeds practicable and satisfactory, and to exempt these parts from rapid deterioration; but so far as relates to obtaining the most economical result for tractive effort in pounds per ton at high speeds the chief attention should be given to the contour of the individual carriages and of the train as a whole. Improved bearings will not affect the air resistance.

TRACTION RESISTANCE AT CONSTANT SPEED

the air resistance, but when a train is composed of many vehicles, it must, so far as practicable, present continuous unbroken surfaces from end to end.¹

Curves materially increase the train resistance, not only at low, but at high, speeds. At moderate speeds, measurements have often shown 100 per cent. increase in the train resistance, even on well-designed curves of fairly large radius.²

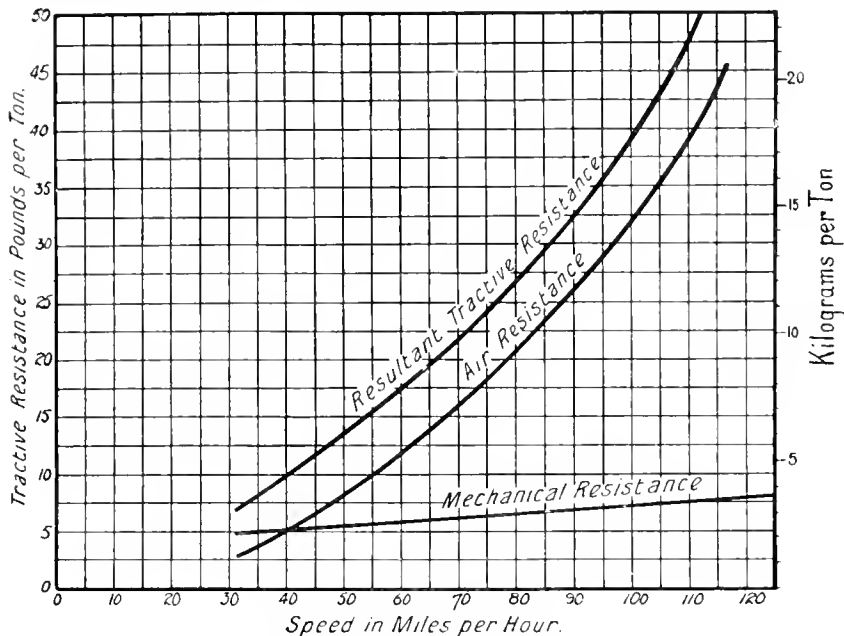

Fig. 8. CURVES OF COMPONENT AND RESULTANT TRACTIVE RESISTANCE FOR 83-TON 75-FOOT CAR, DEDUCED FROM BERLIN-ZOSSFEN TESTS.

Heavily loaded trains have a resistance considerably lower (as expressed in pounds per ton) than light trains.³ This consideration is of importance chiefly in

¹ ". . . At high speeds the air resistance is by far the most important factor, and that the proper shape of the car has to be very carefully determined."—Siemens, "Proceedings of the Institution of Electrical Engineers" (May 26th, 1904).

² "Attention must also be paid to those details of design which will reduce the train resistance, and more especially that element thereof known as 'wind resistance,' which is by far the greatest component of train resistance. Smooth, flat sides, with the platform ends rounded or tapered, and enclosed, are among the simple and effective methods employed. It is astonishing what a saving in watt-hours per ton mile, or per car mile, the application of the simple methods above suggested will produce, as indicated by recent tests."—Gottshall, "Electric Railway Economics," p. 152.

³ "An attempt had also been made to determine the effect of curves on the tractive resistance, but it had been found to be very difficult to do so on account of the curves on the line being so short. The results of three tests on a curve having a radius of 390 ft. gave 27.9 lbs. per ton at 16.5 miles per hour, whereas on the straight road the result was 12.3 lbs. per ton, leaving about 15 lbs. per ton due to the curve alone. Six experiments had been made on a curve of 540 ft. radius, giving 22.6 lbs. per ton at 13½ miles per hour, whereas on the level it was 11.3 lbs. per ton, leaving 11.3 lbs. per ton due to the curve."—McMahon, "Proceedings of the Institution of Civil Engineers" (1901), Vol. CXLVII., p. 215.

³ "With a train of empty wagons 1,830 ft. long, the resistance had been found to be 18.3 lbs. per ton at a speed of 26 miles per hour; a train of full wagons 1,045 ft. long had given 9.1 lbs. per ton at 29 miles per hour, and another of the same length, as low a figure as 6.2 lbs. per ton at 28 miles per hour. He trusted, however, that these figures would not be regarded as results which could be finally established without further proof."—Aspinall, "Proceedings of the Institution of Civil Engineers" (1901), Vol. CXLVII., p. 197.

ELECTRIC RAILWAY ENGINEERING

freight service, since in passenger service the weight of the passengers is but an inconsiderable percentage of the weight of the train in which they travel: *i.e.*, whereas the goods transported constitute the greater part of the weight of the train in freight service, the passengers transported, including their luggage, rarely constitute much more than 10 per cent. of the total weight of the train. In a "sleeper" the occupants constitute less than 2·2 per cent. of the total weight hauled.

From the statement that heavily loaded trains have a resistance considerably lower as expressed in pounds per ton (*i.e.*, a lower "specific resistance") than light trains, it might naturally be concluded that locomotives, which have a far higher weight in proportion to their length than the carriages they haul, would require a less tractive effort per ton of weight for a given speed. This is, however, not the case. Although in steam practice, with a passenger train having a total weight of 300 tons, the locomotive would weigh but 75 to 100 tons, or 25 per cent. to 33 per cent. of the total weight, from 35 per cent. to 55 per cent. of the power indicated by the

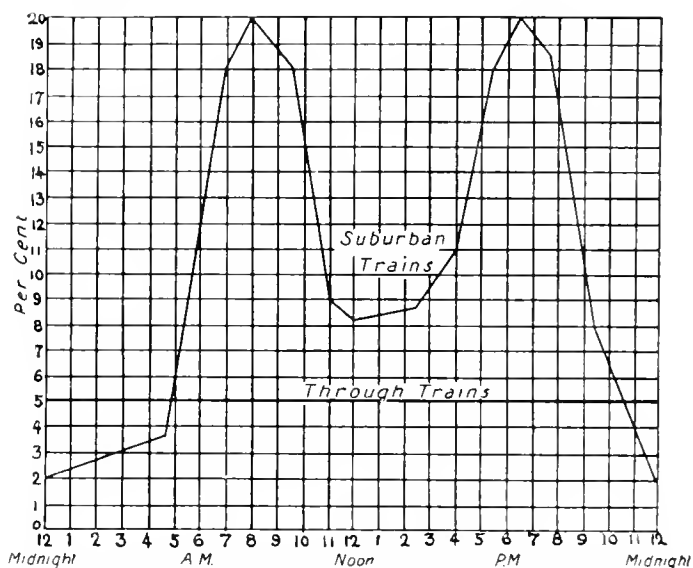

Fig. 9. PERCENTAGE OF PASSENGER WEIGHT TO TOTAL TRAIN WEIGHT
(GRAND CENTRAL STATION TO MOTT HAVEN JUNCTION).

locomotive would be employed in the losses in the locomotive and in the power required to propel it, thus leaving but from 45 per cent. to 65 per cent. of the indicated power available for propelling the rest of the train.¹ Incidentally this

¹ "In order to see how much power the locomotive absorbed as compared with the train, a certain number of experiments had been tried on the Lancashire and Yorkshire Railway, and it had been found that the ten-wheeled engine (No. 1392) absorbed 34 per cent. of the total horse-power. Mr. W. M. Smith ('Proceedings of the Institution of Mechanical Engineers,' 1898, p. 605) had given the results of his experiments as about 36 per cent. of the total horse-power; and Mr. Druitt Halpin had stated ('Proceedings of the Institution of Mechanical Engineers,' 1889, p. 150) that the Eastern Railway of France had found that the engine absorbed 57 per cent. of the total horse-power developed; while Dr. P. H. Dudley gave it at 55·6 per cent., and Mr. Barbier at 48 per cent. Probably 34 per cent. or 36 per cent. was about the right percentage, the other figures being much too high; at any rate, the experiments referred to in the paper rather pointed to that conclusion, though, of course, the actual figure depended on the load behind the engine."—Aspinall, "Proceedings of the Institution of Civil Engineers" (1901), Vol. CXLVII., p. 197.

TRACTION RESISTANCE AT CONSTANT SPEED

is an important fact to keep in mind in comparing the relative merits of traction by steam and electricity. In short trains, the percentage of the energy employed for the locomotive itself, is still higher.

As an interesting instance of the small percentage which the live load constitutes in through and in suburban service respectively, there are given in Fig. 9, some curves applying to the conditions on the section of the New York Central and Hudson River Railway between the Grand Central Station in New York City and Mott Haven Junction. These curves are taken from a paper by Arnold published on p. 876 of Vol. XIX. of the "Transactions of the American Institute of Electrical Engineers."¹

A sleeper weighs some $3\frac{1}{2}$ tons per passenger when carrying its full complement of passengers. In this case, the passenger represents less than 2 per cent. of the total weight hauled. Ashe and Keiley refer to this matter as follows:—

"In all classes of electric cars the dead weight of car varies from about 70 per cent. to 90 per cent. of the total weight plus the weight of seated passengers, and the power required for the operation of a given service varies directly as the weight of the cars moved. It is evident that the cost of the power plant and transmission system would be approximately proportional to the weight of the cars if electric heaters were not used.

"The ratio between dead weight and total weight of cars varies between wide limits; and on account of the indefinite character of the load, due to standing passengers, it would be difficult to give even approximate figures. However, a rough general statement of the amount of dead weight of car *per seated passenger* would be as follows:—Closed trolley car, longitudinal seats, 600 to 700 lbs. per seated passenger; open trolley car, full cross seats, 400 to 500 lbs. per seated passenger; and suburban closed car, cross seats, and centre aisle, 1,000 to 1,200 lbs. per seated passenger."—"Electric Railways," Ashe and Keiley, pp. 171—172 (London, Constable & Co., 1905).

The direction and intensity of the wind may considerably increase or decrease the tractive effort required of the steam locomotive or of the electric motors, and this again is considerably dependent upon the design of the train as regards the contour of the front and rear ends, the vestibuling, and other details. Curves also exert a great influence, which is, however, difficult to predetermine.² The influence of gradients is readily determined by the principles of ordinary mechanics, and is equivalent to a positive or negative tractive effort of 22 lbs. per ton for a 1 per cent. gradient.

While all these points require attention in specific cases, one must have some simple basis for the further preliminary study of the mechanics of heavy electric traction. The curves of Fig. 2, on p. 6, will be taken as the ultimate basis for this preliminary study.

Although the length of the train and the weight in tons per foot of overall length, constitute the most correct basis for final reference, it is much more useful, even at some slight sacrifice of accuracy, to derive curves in which the length of the train in feet is replaced by the weight of the train in tons. For this purpose we must obtain representative figures for the weights of heavy single cars and of trains, per foot of overall length. A number of such figures have been compiled in Table II.

¹ It has been pointed out that only from 15 to 20 per cent. of a fully loaded train consists of a paying load, and with an average load as carried throughout the day, this percentage will be reduced to 10 per cent. or less—that is, nine-tenths of the energy consumed in moving this train at a constant speed is wasted.—Armstrong, "Transactions of the American Institution of Electrical Engineers" (1898), Vol. XV., p. 375.

² For the tractive resistance on curves, see also the footnote on p. 11.

ELECTRIC RAILWAY ENGINEERING

TABLE II.—*Rolling Stock Data.*

	Number of Seats.	Overall Length in Feet.	Loaded Weight in Metric Tons.	Loaded Weight in Metric Tons per Foot of Overall Length.	Seats per Foot.	Seats per Metric Ton of Loaded Weight.
Steam railroad standard suburban train, made up of seven eight-wheeled coaches and locomotive	520	389	240	0.62	1.33	2.16
Great Northern and City continuous-current motor-car train, seven cars	422	355	195	0.55	1.19	2.16
Mersey Railway continuous-current motor-car train	292	300	138	0.46	0.97	2.10
Manhattan Elevated standard continuous-current train, made up of four motor-cars and two trailer cars	286	282	125	0.44	1.01	2.29
Standard City and South London continuous-current four-car train, with locomotive	128	141	41	0.35	0.91	3.12
Zossen car (S. and H.)	48	76	77	1.01	0.63	0.62
Zossen car (A.E.G.)	48	72	93	1.29	0.66	0.52
Interborough Railway Co. fireproof car (Ashe and Keiley, "Electric Railways," p. 178)	52	52	27	0.52	1.0	1.9
Burgdorf-Thun three-phase motor car	66	49	36	0.74	1.35	1.83
Chicago and Joliet inter-urban continuous-current motor car	36	23	0.64
Closed trolley car with longitudinal seats (Ashe and Keiley, "Electric Railways," p. 172)	3.1 to 2.6
Open trolley car with full cross seats, as employed in summer in America (Ashe and Keiley, "Electric Railways," p. 172)	4.7 to 3.7
Suburban closed car with cross seats and centre aisle (Ashe and Keiley, "Electric Railways," p. 172)	2.0 to 1.6
Liverpool Overhead Railway	57	45	38	0.845	1.27	1.5
Metropolitan Elevated Railway (Chicago), west side	40	40	1.00	...
Lecco Sondrio Railway (Ganz system), Valtellina	56	57	56.5	0.99	1.02	1.01
Indianapolis and Cincinnati Traction Co., single phase inter-urban car	54	55	46.5	0.85	1.02	1.16
Data given by Armstrong, <i>Street Railway Journal</i> , Vol. XXVI., p. 1068, double truck car	64	60	26	0.43	1.07	2.46
Ditto, double truck car	52	50	18.6	0.37	1.04	2.8
Ditto, double truck car	42	40	13	0.33	1.05	3.22
Ditto, single truck	26	26	6.8	0.26	1.00	3.8
Central London continuous-current seven-car train	324	330	133.5	0.41	0.98	2.42
Central London motor coach	40	46	27.5	0.50	1.15	1.45
Central London trailer coach	48	46	16.4	0.28	0.96	2.82
Metropolitan Railway (London) six-car train	322	320	165	0.52	0.99	1.95
Metropolitan Railway (London) motor coach	49	52.8	40.07	0.77	1.08	1.2
Metropolitan Railway (London) trailer coach	56	52.8	20.4	0.39	0.94	2.75
District Railway (London) seven-car train	328	347	160	0.49	1.06	2.05
District Railway (London) motor coach with luggage compartment	40	49.5	27.5	0.56	1.03	1.75
District Railway (London) motor coach without luggage compartment	48	49.5	27.0	0.55	1.24	1.48
District Railway (London) trailer coach	48	49.5	19.5	0.39	1.03	2.46
Waterloo and City Railway four-car train	220	164	72	0.44	1.34	3.06
Waterloo and City Railway motor car	50	47	1.06	...
Waterloo and City Railway trailer	54	35	1.55	...

TRACTIVE RESISTANCE AT CONSTANT SPEED

It is thus seen that one-half ton per foot of overall length is, *for the present purpose*, sufficiently representative of all except the most abnormal cases of rail traction. Since the curves of Fig. 2, on p. 6, show that the decrease in tractive effort per ton with increasing length of train is relatively slow, owing to the large constant term in the denominator of the right-hand side of Aspinall's formula (see p. 5) and to the constant first term in the formula, we may rightly take this figure of one-half ton per foot length in transforming the curves from length to weight. The curves given in Figs. 10 and 11 have thus been deduced for trains of a total weight of 50, 100, 200, 400, and 800 tons, and from this point we shall rarely refer back to the former curves, but shall base our study on the curves in Figs. 10 and 11. In Fig. 10 the speed is given in miles per hour, but in Fig. 11 the speed in feet per second is used, for,

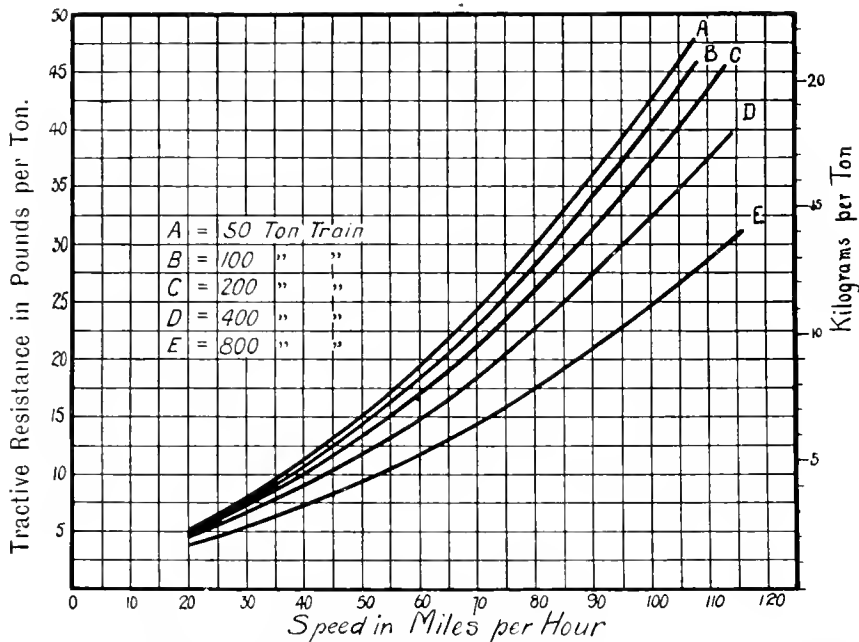

Fig. 10. CURVES OF TRACTIVE RESISTANCE IN POUNDS PER TON FOR VARIOUS SPEEDS IN MILES PER HOUR.

as we shall shortly learn, the use of this expression facilitates some subsequent calculations. In Fig. 12 are given corresponding curves in which the kilowatts at the axles per ton weight of train are taken as ordinates, and the speed in miles per hour as abscissæ. In Fig. 13 the total kilowatts at the axles are plotted against the speed.

Owing to the very lucid and condensed form in which Carter ("Technical Considerations in Electric Railway Engineering") handles this subject, and to the fact that he bases his determinations on the, in some respects, more logical basis of surface resistance, so far as relates to tractive effort at constant speed, and on weight, so far as it relates to constant acceleration, the authors have thought it well to include verbatim from the above paper the extract in which this subject is dealt with. The extract in question is as follows:—

"The forces resisting the motion of the train consist of the easily calculated positive or negative component due to grade, proportional to the actual weight of the

ELECTRIC RAILWAY ENGINEERING

train, and the rather uncertain 'train resistance,' composed of journal and flange friction, air resistance, etc. There is a lack of reliable data on the resistance offered

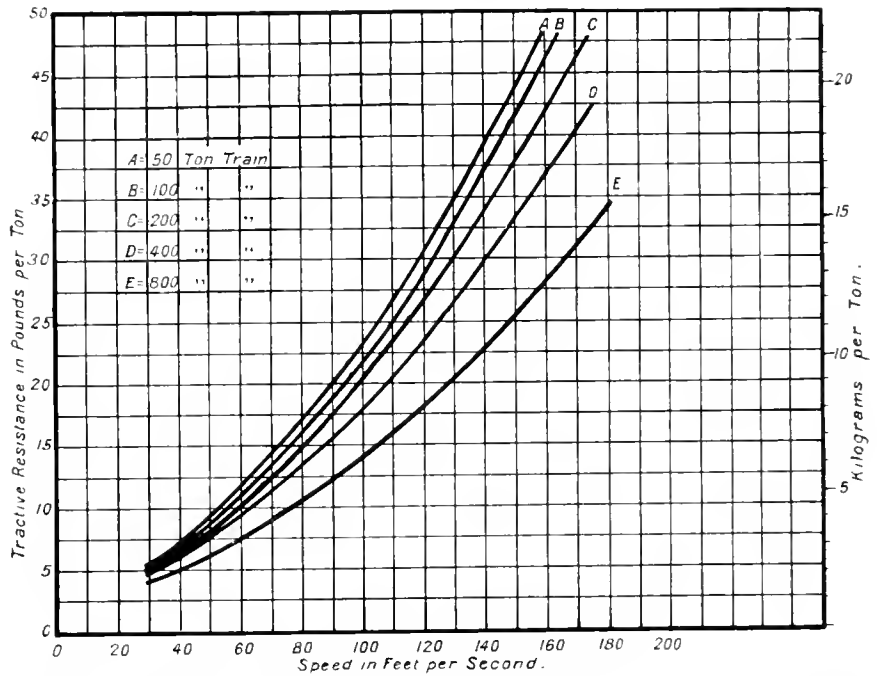

Fig. 11. CURVES OF TRACTIVE RESISTANCE IN POUNDS PER TON FOR VARIOUS SPEEDS IN FEET PER SECOND.

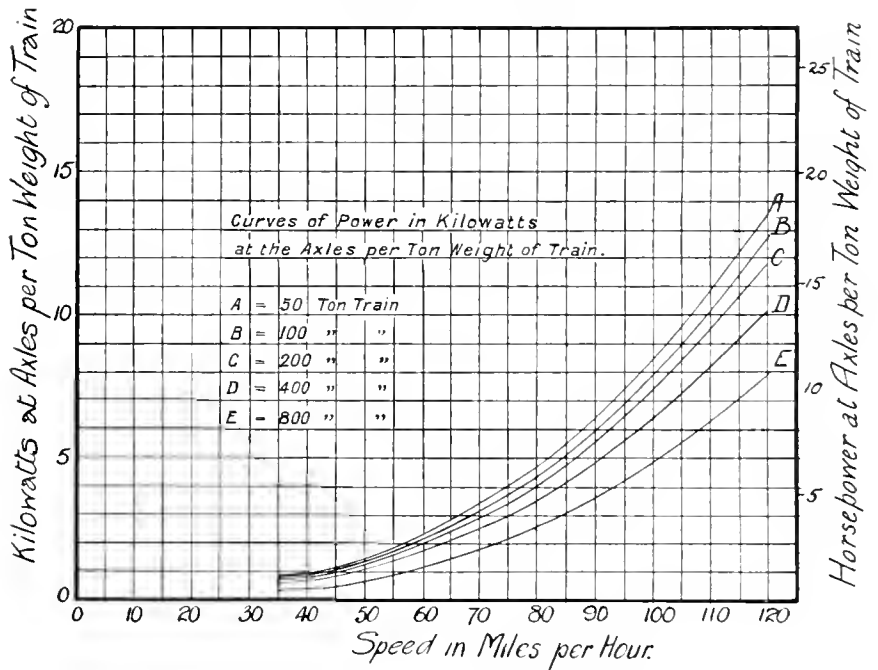

Fig. 12. CURVES OF POWER IN KILOWATTS AT THE AXLES PER TON WEIGHT OF TRAIN.

TRACTIVE RESISTANCE AT CONSTANT SPEED

to the motion of electric trains, which it is hoped will soon be supplied. The classical results of Aspinall were obtained from measurements made from behind a locomotive and tender, and accordingly do not include the head resistance, which is a very important element in the case of electric trains of two or three coaches. The Berlin-Zossen high-speed train resistance tests were made with a single coach of a type totally different from those usually employed in this country. Pending the publication of more suitable data, the author has combined the results of the above-mentioned sets of tests to obtain the working curves of Fig. 14, which he has found to agree very fairly with the results of such isolated tests on electric trains as he has been able to make. The variable portion is expressed in terms of the *dimensions* of the train rather than of the *weight*, since it must represent principally air resistance, and therefore at any speed can depend only on the external configuration of the train.

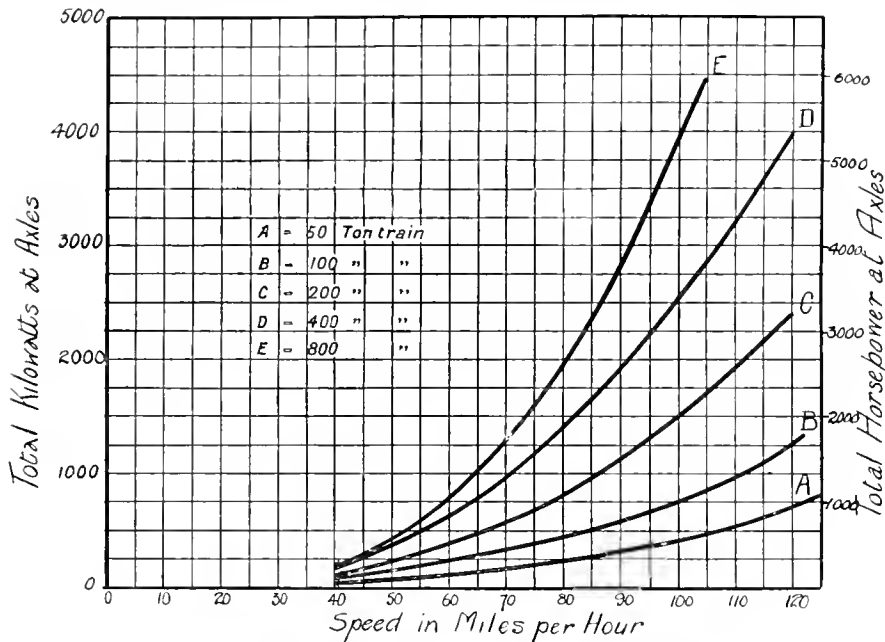

Fig. 13. CURVES OF TOTAL POWER IN KILOWATTS AT AXLES.

The constant portion of the resistance, which is taken from the above-mentioned tests at such low speeds that the static resistance just ceases to be apparent, is probably expressed with sufficient accuracy as proportional to the weight, and appears to be $2\frac{1}{2}$ lbs. to $3\frac{1}{2}$ lbs. per ton. The total train resistance is therefore the amount deduced from the curves of Fig. 14 increased by $2\frac{1}{2}$ lbs. to $3\frac{1}{2}$ lbs. per ton.

"A light train of given external dimensions will, except at low speeds, meet with almost as great a resistance as a heavier-built one of the same dimensions. A train of many coaches experiences much less resistance per coach or per ton than one of two or three coaches, particularly at high speeds. Allowance is made for these facts in the curves of Fig. 14. A long distance high-speed train should, for efficiency, be composed of many coaches, whilst the weight is a secondary consideration. A frequently stopping low-speed train, on the other hand, should be built light, but whether it is composed of few or many coaches is of small importance as far as efficiency is concerned."

We have thus obtained values for the rate of expenditure of energy required at

ELECTRIC RAILWAY ENGINEERING

the axles in moving the train along a well-ballasted, straight, level line at constant speed. This is, of course, a very different case from that generally met in practice. The chief difference is associated with the energy required for acceleration. This accelerating energy, like the energy required for overcoming the tractive resistance, is customarily supplied to the axles by motors, and is subsequently wasted in braking. In some roads, however—such, for instance, as the Central London Railway—accelerating gradients contribute as much as one-fourth of the energy supplied to the train,¹ and similar retarding gradients assist the brakes at stopping.

In the present condition of engineering nomenclature, it is impossible to avoid

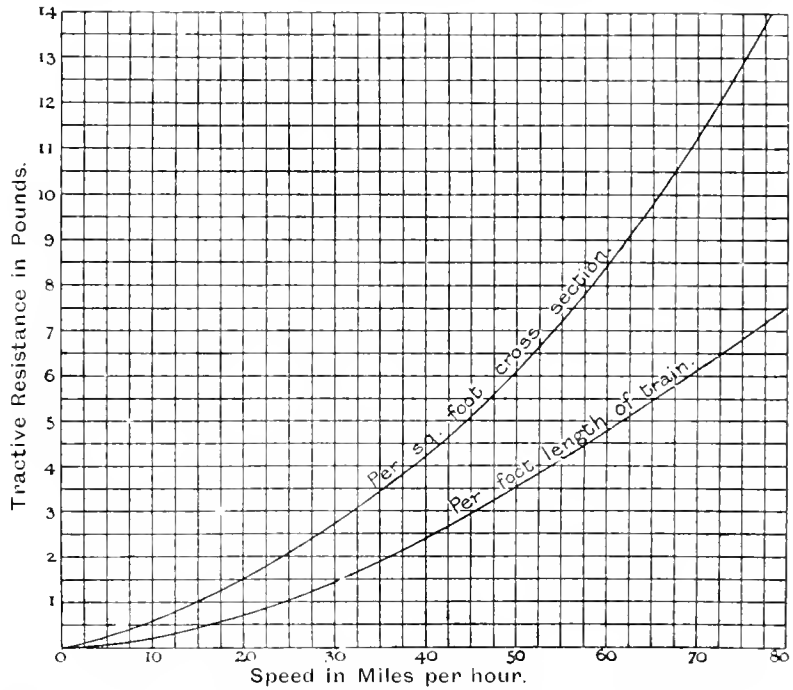

Fig. 14. CARTER'S TRAIN RESISTANCE CURVES, GIVING THE VARIABLE COMPONENT OF TRAIN RESISTANCE.

the employment of mixed units. To facilitate the conversion of speeds and distances from one system of units to another, we have given the equivalent values in Tables III., IV., V., and VI.

TABLE III.

Equivalent Values of Distance, English and Metric.

	Kilometre.	Metres.	Centimetres.	Miles.	Feet.	Inches.
1 kilometre	1	1000	100000	0.621	3280	39400
1 metre	0.001	1	100	0.000621	3.28	39.4
1 centimetre	0.00001	0.01	1	0.00000621	0.0328	0.394
1 mile	1.609	1609	160900	1	5280	63400
1 foot	0.000305	0.305	30.5	0.0001894	1	12
1 inch	0.0000254	0.0254	2.54	0.00001579	0.0833	1

¹ The *actual* energy supplied by the gradient is, of course, solely dependent on the height through which the train descends. On the Central London Railway, the energy supplied by the gradients is about fourteen watt-hours per ton mile, or about a quarter of the whole energy supplied to the train.

TRACTIVE RESISTANCE AT CONSTANT SPEED

TABLE IV.

Equivalent Values of Speed, English and Metric.

	Kilometres per Hour.	Metres per Second.	Miles per Hour.	Feet per Second.
1 Kilometre per hour	1	0·2778	·621	0·911
1 Metre per second	3·60	1	2·237	3·280
1 Mile per hour	1·609	0·447	1	1·467
1 Foot per second	1·097	0·3048	0·682	1

TABLE V.

Comparative Table of Speeds.

Kilometres per Hour.	Metres per Second.	Miles per Hour.	Feet per Minute.	Feet per Second.	Kilometres per Hour.	Metres per Second.	Miles per Hour.	Feet per Minute.	Feet per Second.
2	0·5554	1·242	109·3	1·822	82	22·77	50·92	4481	74·70
4	1·110	2·485	219·7	3·645	84	23·32	52·18	4592	76·54
6	1·666	3·726	328·1	5·467	86	23·88	53·40	4702	78·34
8	2·221	4·960	437·4	7·290	88	24·42	54·68	4808	80·16
10	2·778	6·213	546·8	9·113	90	24·99	55·61	4921	82·01
12	3·332	7·455	656·1	10·93	92	25·54	57·12	5028	83·80
14	3·887	8·694	765·1	12·75	94	26·10	58·37	5137	85·63
16	4·443	9·940	874·8	14·58	96	26·64	59·64	5248	87·44
18	4·998	11·18	984·2	16·40	98	27·21	60·68	5355	89·20
20	5·554	12·42	1093	18·22	100	27·78	62·13	5466	91·13
22	6·108	13·66	1202	20·04	102	28·32	63·34	5574	92·92
24	6·664	14·91	1312	21·86	104	28·80	64·60	5684	94·72
26	7·220	16·15	1421	23·68	106	29·43	65·82	5793	96·56
28	7·774	17·38	1530	25·50	108	29·98	67·08	5904	98·40
30	8·331	18·63	1640	27·31	110	30·54	68·34	6014	100·2
32	8·884	19·88	1749	29·16	112	31·08	69·52	6120	102·0
34	9·441	21·11	1858	30·97	114	31·65	70·79	6230	103·8
36	9·996	22·36	1968	32·80	116	32·20	72·04	6342	105·4
38	10·55	23·59	2076	34·62	118	32·77	73·27	6448	107·5
40	11·10	24·85	2197	36·45	120	33·32	74·55	6561	109·3
42	11·66	26·09	2296	38·27	122	33·87	75·76	6667	111·1
44	12·21	27·32	2404	40·08	124	34·42	77·00	6776	112·9
46	12·77	28·56	2514	41·90	126	34·99	78·24	6886	114·7
48	13·32	29·82	2624	43·72	128	35·54	79·52	7024	116·6
50	13·88	31·06	2734	45·56	130	36·10	80·77	7108	118·4
52	14·44	32·30	2842	47·36	132	36·64	82·00	7216	120·2
54	14·99	33·51	2952	49·20	134	37·21	83·21	7323	122·0
56	15·54	34·76	3060	51·00	136	37·76	84·44	7432	123·8
58	16·10	36·02	3169	52·73	138	38·32	85·75	7541	125·7
60	16·66	37·27	3281	54·67	140	38·87	86·98	7654	127·6
62	17·21	38·50	3388	56·48	142	39·43	88·18	7760	129·3
64	17·77	39·76	3499	58·32	144	39·98	89·44	7872	131·2
66	18·32	41·00	3608	60·12	146	40·54	90·66	7979	133·0
68	18·88	42·22	3716	61·94	148	41·10	91·90	8088	134·8
70	19·43	43·49	3827	63·79	150	41·64	93·18	8202	136·7
72	19·99	44·72	3936	65·60	152	42·21	94·39	8364	138·4
74	20·55	45·95	4044	67·41	154	42·76	95·63	8416	140·3
76	21·10	47·18	4152	69·24	156	43·32	96·29	8530	142·1
78	21·66	48·46	4265	71·08	158	43·87	98·12	8634	143·9
80	22·21	49·60	4374	72·90	160	44·43	99·10	8748	145·8

ELECTRIC RAILWAY ENGINEERING

TABLE VI.

Comparative Table of Speeds.

Miles per Hour.	Feet per Minute.	Feet per Second.	Kilometres per Hour.	Metres per Second.	Miles per Hour.	Feet per Minute.	Feet per Second.	Kilometres per Hour.	Metres per Second.
2	176	2·931	3·218	0·894	52	4576	76·28	83·66	23·24
4	352	5·868	6·436	1·788	54	4752	79·21	86·88	24·13
6	528	8·802	9·654	2·682	56	4928	82·14	90·09	25·03
8	704	11·73	12·87	3·576	58	5104	85·08	93·32	25·92
10	880	14·67	16·09	4·47	60	5280	88·02	96·54	26·82
12	1056	17·60	19·31	5·364	62	5456	90·96	99·75	27·73
14	1232	20·53	22·53	6·258	64	5632	93·84	102·9	28·60
16	1408	23·47	25·74	7·152	66	5808	96·82	106·1	29·50
18	1584	26·40	28·96	8·046	68	5984	99·74	109·4	30·38
20	1760	29·34	32·18	8·940	70	6160	102·7	112·6	31·29
22	1936	32·27	35·40	9·834	72	6336	105·6	115·8	32·18
24	2112	35·20	38·60	10·72	74	6512	108·5	119·0	33·07
26	2288	38·14	41·83	11·62	76	6688	111·4	122·3	33·96
28	2464	41·06	45·06	12·51	78	6864	114·4	125·5	34·86
30	2640	44·01	48·27	13·41	80	7040	117·2	128·7	35·76
32	2816	46·92	51·48	14·30	82	7216	120·2	131·9	36·65
34	2992	49·87	54·70	15·19	84	7392	123·2	135·1	37·54
36	3168	52·81	57·92	16·09	86	7568	126·1	138·3	38·44
38	3344	55·74	61·14	16·98	88	7744	129·0	141·6	39·32
40	3520	58·68	64·36	17·88	90	7920	132·0	144·8	40·23
42	3696	61·61	67·57	18·77	92	8096	134·9	148·0	41·12
44	3872	64·54	70·79	19·66	94	8272	137·8	151·2	42·01
46	4048	67·48	74·01	20·56	96	8448	140·8	154·5	42·90
48	4224	70·41	77·24	21·45	98	8624	143·8	157·6	43·80
50	4400	73·35	80·45	22·35	100	8800	146·7	160·9	44·70

Chapter II

ACCELERATION

$$\begin{aligned}\text{Force} &= \text{Mass} \times \text{Acceleration} \\ &= \frac{\text{Weight}}{g} \times \text{Acceleration}.\end{aligned}$$

CONSIDER first an acceleration of 1 mile per hour per second, or 1.47 ft. per second per second. The tractive force required to impart to 1 metric ton an acceleration of 1 mile per hour per second

$$= \frac{2,200}{32.2} \times 1.47 = 100 \text{ lbs.}$$

Useful Rule.—We have thus the useful rule that on a level track a tractive force of 100 lbs. per metric ton, in addition to the force required to overcome the tractive resistance, imparts to a train an acceleration of 1 mile per hour per second. Strictly speaking, one should make an additional allowance for the rotational energy of the wheels and armatures.¹ This is a matter of from 3 per cent. to 7 per cent. of the whole kinetic energy of the train, depending on the load per axle and on the

¹ "A Consideration of the Inertia of the Rotating Parts of a Train," Storer, "Transactions of the American Institute of Electrical Engineers," Vol. XIX. (1902), p. 165.

Carter ("Technical Considerations in Electric Railway Engineering," paper read before the Institution of Electrical Engineers, January 25th, 1906) gives rather higher values for the percentage increase in the kinetic energy of the train due to the rotating parts. He sets the matter forth as follows:—"The weight of the train to be employed in calculating the acceleration due to any force is a certain spurious 'effective weight,' composed of the true weight, and an increment due to the rotation of the wheels and armatures. This increment is not difficult to obtain, and will be merely stated here. If W be the weight of a wheel, r its radius at the tread, and k its radius of gyration, the increment of weight due to the rotation of the wheel is $W \left(\frac{k}{r}\right)^2$. In an average steel railway wheel $\left(\frac{k}{r}\right)^2 = 0.6$ approximately.

If W^a be the weight of an armature, r^a its radius, k^a its radius of gyration, and γ the ratio of gear reduction, the increment of weight due to the rotation of the armature is $W^a \left(\gamma \frac{k^a}{r^a}\right)^2 = W^a \left(\gamma \frac{k^a r^a}{r^a}\right)^2$. For a continuous-current armature $\left(\frac{k^a}{r^a}\right)^2 = 0.5$ approximately. Thus if $W = 800$ lbs., $W^a = 1,600$ lbs., $\gamma = 3$, $\frac{r^a}{r} = \frac{1}{2}$, the addition for rotary inertia will be approximately 480 lbs. per wheel and 1,800 lbs. per armature.

In the case of suburban trains operated by continuous-current motors, the amount to be added on account of rotary inertia, will usually be some 8 or 10 per cent. of the weight of the train, whilst with single-phase alternating-current motors, the increment may amount to double

ELECTRIC RAILWAY ENGINEERING

construction of the rotating parts. To avoid complicating the question, this additional allowance will not be made, but will subsequently be covered by a margin which will also provide for the energy consumed in air-pumps, control apparatus, and, in some cases, train and station lighting, and power for auxiliary machinery.

Table VII. gives values for the tractive force in pounds per ton, required during the accelerating interval, in addition to the tractive force necessary for overcoming friction. In England, rates of acceleration, so far as traction questions are concerned, are almost always expressed either in miles per hour per second, or in feet per second per second.

TABLE VII.

Tractive Force and Accelerating Rate.

Acceleration expressed in metres per second per second	0.112	0.224	0.336	0.447	0.560	0.671	0.784	0.895	1.00	1.12	1.225	1.335
Acceleration expressed in kilometres per hour per second	0.402	0.805	1.21	1.61	2.01	2.42	2.82	3.22	3.62	4.02	4.42	4.83
Acceleration expressed in miles per hour per second	0.25	0.50	0.75	1.00	1.25	1.50	1.75	2.00	2.25	2.5	2.75	3.0
Acceleration expressed in feet per minute per second	22.0	44.0	66.0	88.0	110	132	154	176	198	220	242	264
Acceleration expressed in feet per second per second	0.366	0.733	1.10	1.47	1.83	2.20	2.56	2.93	3.30	3.67	4.04	4.42
Tractive force in pounds per ton	25.0	50.0	75.0	100	125	150	175	200	225	250	275	300
Tractive force in kilogrammes per ton	11.3	22.7	34.0	45.5	56.7	68.0	79.5	90.7	102.0	114.0	125.0	136.0

Letting

S = speed,
 a = acceleration,
 D = distance,
 T = time,

then in any given system of units we have the following fundamental relations:—

$$\begin{aligned}
 S &= aT; \\
 D &= \frac{1}{2} aT^2; \\
 \therefore S &= \sqrt{2aD}.
 \end{aligned}$$

In Fig. 15 (A, B, C, D, E and F) six groups of curves of speed and time, distance and time, and speed and distance, are given for the accelerating interval.

From the speed-time curves in Figs. 15A and 15B and the distance-time curves in Figs. 15C and 15D we may obtain, for any given time in seconds from the start, the speed and the distance covered, employing any practicable acceleration. The speed-distance curves of Figs. 15E and 15F are derived directly

as much, on account of the greater number and weight of armatures and their generally higher peripheral speed."

See also an article in *Engineering* for March 9th, 1906, p. 295, entitled "Energy Expended on Car Wheel Acceleration." In this article the calculations are worked out for a special case.

Speed in Miles per Hour & Distance in Miles

Speed in Feet per Second & Distance in Feet.

Speed-Time Curves

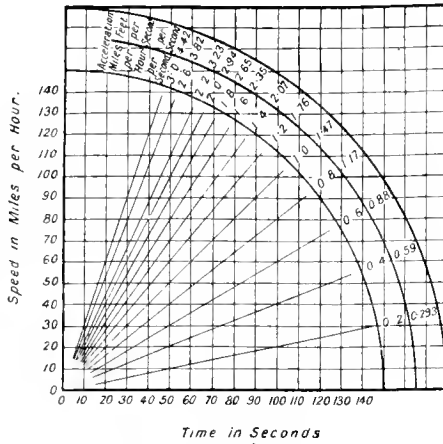

ACCELERATION

from the speed-time curves of Figs. 15A and 15B, and the distance-time curves of Figs. 15c and 15d.

Let us now consider the case of a train to be operated over a straight, level track, with a stop every mile, at an average speed of 30 miles per hour between stops, for each 1-mile section. The train must evidently cover such a 1-mile section in two minutes. The rates of acceleration and braking will be assumed to be equal.

According to the conditions of practice in any particular case, the rate of retardation during braking, would be taken greater than, equal to, or less than the rate of acceleration. Moreover, in short runs, constant speed between the processes of accelerating and braking is not generally maintained in electrical operations: the power is often cut off directly the maximum speed is reached, or shortly thereafter, and the friction

of the train is thus used to procure a part of the retardation, a less amount of energy being in consequence dissipated at the brake shoes. This naturally leads to correspondingly improved economy. In analysing any particular case where such methods are employed, the values determined upon as regards accelerating, braking, and coasting are used in the estimation of the running conditions. *But since these details of operation vary enormously in different cases according to the conditions of service, one would, by endeavouring to take them into consideration in studying the general case, simply lessen the value of the broad conclusions at which one wishes to arrive.* Therefore, in the first instance, we shall assume equal rates

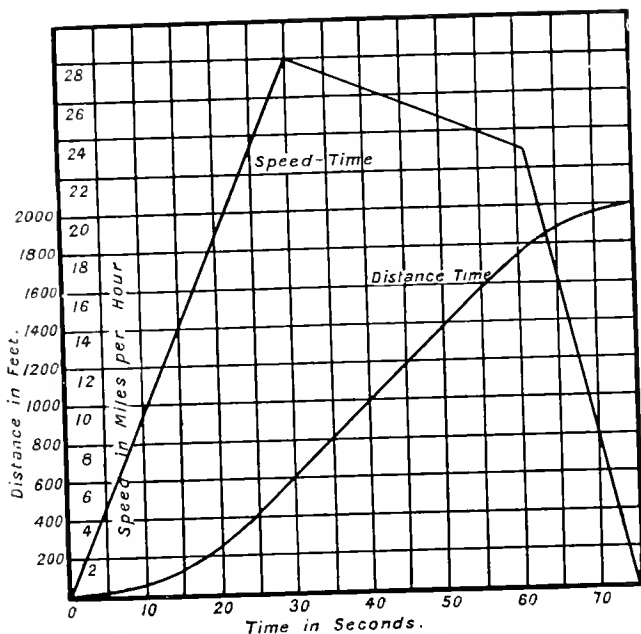

Fig. 16. SPEED-DISTANCE TIME CURVES (ARMSTRONG'S).

Distance = 2,000 feet.
 Time = 75 seconds
 Rate of Acceleration = 0.93 miles per hour per second.
 Friction = 16 lbs. per metric ton.
 Braking Effort = 100 lbs. per metric ton.

of acceleration and retardation. For the interval not required for these two operations, we shall assume that the train is run at constant speed. A special study will subsequently be made of the extent of the error in the results, consequent upon employing these assumptions. When the study of the general case has been completed, we shall illustrate the analysis of *special* cases, and shall ascertain and employ the precise rates of acceleration and retardation and the amount of "coasting" suitable for obtaining the best conditions in each case.

For the present purpose it will suffice to briefly illustrate the point involved by reference to Figs. 16 and 17, which are taken from Armstrong's paper, entitled "Some Phases of the Rapid Transit Problem," read before the American Institute of Electrical Engineers (1898, Vol. XV., p. 363). In deriving these curves,

ELECTRIC RAILWAY ENGINEERING

Armstrong has made the assumptions set forth below the titles of Figs. 16 and 17. For the purposes of a general survey of the subject, and in view of the conditions as regards rolling stock and permanent way, and the low speeds considered, Armstrong is not altogether unjustified in taking for the friction at all speeds, the mean value of 16 lbs. per metric ton, although, as we have already seen from Fig. 2, on p. 6, the friction in pounds per ton varies through a wide range with variation in the speed.¹ These two curves (Figs. 16 and 17) are based on an accelerating rate of 0.93 miles per hour per second, and upon a braking effort of 160 lbs. per metric ton, corresponding to a retardation of 1.6 miles per hour per second. In the curve of Fig. 16 the power is cut off immediately at the end of the accelerating interval (*i.e.*, at the end of 30 seconds, when a speed of 28 miles per hour has been attained, a distance of 600 ft. having been covered), and the train coasts for the next 31 seconds (*i.e.*, for the next 1,200 ft.). The brakes are then applied, bringing the train to rest after 75 seconds from the start, the distance of 2,000 ft. having been covered at the average speed of 18.2 miles per hour.

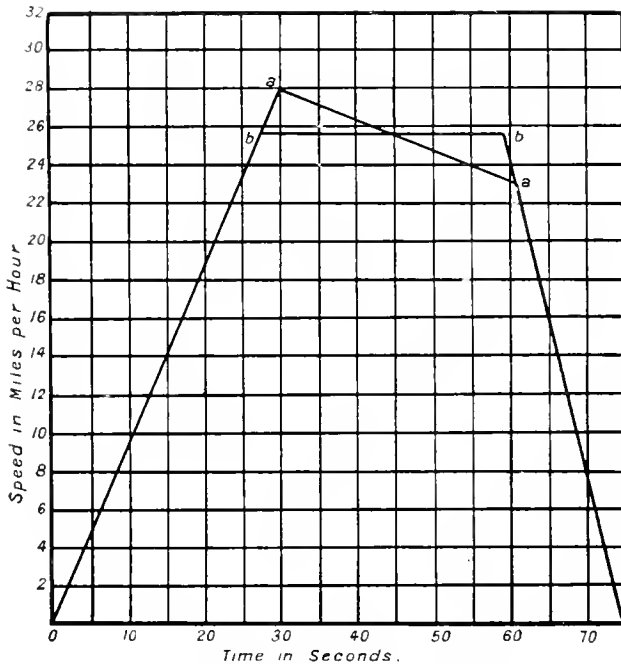

Fig. 17. SPEED-DISTANCE-TIME CURVES.

Distance = 2,000 feet.
Time = 75 seconds.
Friction = 16 lbs. per metric ton.
Braking Effort = 160 lbs. per metric ton.

lower maximum speed, and, as we shall see later, a lower *maximum power*, is required for a given average schedule speed; but, as we shall also see later, this is at the cost of some 9 per cent. more *total energy* consumed during the run. The relative merits of these two methods, as also that of

In Fig. 17 Armstrong has illustrated an alternative method (shown in the cycle *o b b 75*) of covering the same distance at the same schedule speed of 18.2 miles per hour, sufficient power being kept on, until the brakes are applied, to maintain the constant speed of 25.5 miles per hour attained at the end of 27 seconds of acceleration.

By operating on the curve *o b b 75*, instead of on the curve *o a a 75*, 9 per cent.

¹ "It may be said that while there is no material error in assuming constant train resistance for all cases where the speed does not exceed 25 miles per hour, yet above these speeds there is a possibility of error which becomes a certainty when the speeds reach 40, 50, or 60 miles, the amount of error increasing with the speed. This matter is now so well understood that a mere mention is sufficient. Very little reasoning will show that the increase of train resistance as a function of the speed cannot be left out of consideration in any computations relating to high-speed service."—Gotshall, "Transactions of the American Institute of Electrical Engineers," Vol. XIX. (1902), p. 184.

ACCELERATION

"acceleration on the motor curve," cannot well be considered at any length until the subject of tractive force and energy is taken up. It may here be briefly stated that cycles approaching that illustrated in Fig. 16 and in curve *o a a 75* of Fig. 17 are more suitable for frequent stop service at a high average speed; but that the longer the run between stops, or the lower the average speed the more does the cycle employed in actual service resemble that illustrated by the diagram *o b b 75* of Fig. 17. The error introduced by adopting the latter type of diagram throughout this preliminary study, is the greater the shorter the run between stops and the higher the average speed; but the error is on the safe side, and immense advantage is gained in obtaining a preliminary broad view of the limiting factors, to free this necessarily complex investigation from as many subsidiary considerations as practicable.

Returning to the general case of a train to be operated over a straight level track with a stop every mile and at an average speed of 30 miles per hour for each 1-mile section (assuming equal rates of acceleration and braking), it is evident that the very lowest rate of acceleration must enable the train, during an accelerating interval of 60 seconds, to cover a distance of 0.50 miles. Fig. 18A shows us that the corresponding rate of acceleration is 1 mile per hour per second (1.47 ft. per second per second). We may, if we choose, find from Fig. 15A that the speed at the end of 60 seconds is 60 miles per hour (reading off the speed from the intersection of the ordinate at 60 seconds, with the line of reference for an acceleration of 1 mile per hour per second), although this is obvious without consulting a diagram.

The speed-time curve would thus be the full line curve of Fig. 18A, which is marked "1 mile" to indicate that an accelerating rate of 1 mile per hour per second is employed. The accelerating half is transferred directly from Fig. 15A, and the braking half is merely the reverse of this curve. The corresponding distance-time curve is given in Fig. 18B; the accelerating half is transferred directly from Fig. 15c. Fig. 18c is transferred directly from Fig. 15E for an acceleration of 1 mile per hour per second, and gives

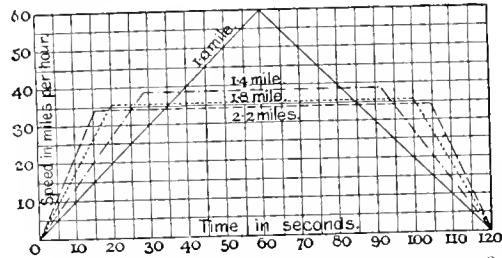

A—Speed-Time Curves for accelerations of 1.0, 1.4, 1.8, and 2.2 miles per hour per second.

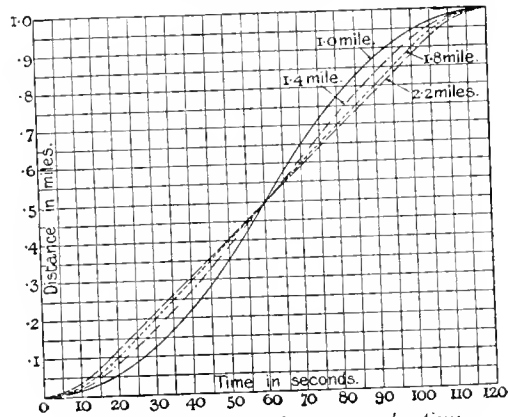

B—Distance-Time Curves for same accelerations.

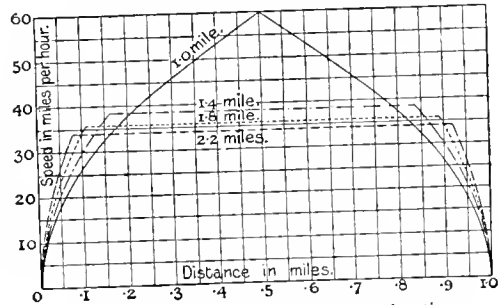

C—Speed-Distance Curves for same accelerations

Fig. 18 (A, B, AND C). SPEED-DISTANCE-TIME CURVES.

For a one-mile run at an average speed of 30 miles per hour; time from start to stop = 2 minutes.

ELECTRIC RAILWAY ENGINEERING

the speeds as ordinates in terms of distances as abscissa. These are the three characteristic curves for the case of a train travelling over a 1-mile section at an average speed of 30 miles per hour for the minimum rate of acceleration and braking permissible for this schedule.

Let us next take an acceleration of 1·4 miles per hour per second (2·07 ft. per second per second), and let it be assumed that the braking is at an equal rate.

Let x = duration of accelerating interval in seconds.

Then $120 - 2x$ = duration of constant speed interval.

The distance in feet covered during acceleration = $0\cdot5 \times 2\cdot07 \times x^2$.

Speed in feet per second attained at end of accelerating interval = $2\cdot07 \times x$.

Distance in feet covered at constant speed = $2\cdot07 \times x \times (120 - 2x)$.

Distance in feet covered during braking = $0\cdot5 \times 2\cdot07 \times x^2$.

Total distance = 5,280 ft.

From these values we readily derive the following equation:—

$$2\cdot07x^2 - 248x + 5,280 = 0;$$

$$x^2 - 120x + 2,540 = 0;$$

$$\therefore x^2 - 120x + 3,600 = 1,060;$$

$$x - 60 = -32\cdot5;$$

$$x = 27\cdot5 \text{ seconds.}$$

From Fig. 15c we see that after 27·5 seconds of acceleration at a rate of 1·4 miles per hour per second a distance of 0·15 miles will have been covered; and from Fig. 15a it is seen that a speed of 38·8 miles per hour will have been attained. During the succeeding 65 seconds the speed will be constant at this value, and a distance of 0·70 miles will be covered at constant speed. During the remaining 27·5 seconds the brakes will be so applied as to produce a retardation of 1·4 miles per hour per second, and the train will arrive at the end of the mile section in just 120 seconds.

If we denote by

x the duration of the accelerating interval in seconds,

T the duration of the run from start to stop in seconds,

A the distance from start to stop in feet,

a the rate of acceleration in feet per second per second.

$$\text{then } x = \frac{T}{2} - \sqrt{\left(\frac{T}{2}\right)^2 - \frac{A}{a}}.$$

Instead of by calculation, one may often prefer to determine the accelerating interval by one or two trials from the curves of Figs. 15A to 15F. The three characteristic curves for this accelerating rate of 1·4 miles per hour per second are shown in the 1·4 mile curves of Figs. 18A, 18B, and 18C; and it will be readily perceived that they are merely made up by combining curves available in Figs. 15A to 15F.

Similar sets of characteristic curves for other accelerations, but for the same mean speed of 30 miles per hour and the same distance of 1 mile, are also given in Figs. 18A, 18B, and 18C.

For this case of a level 1-mile section, corresponding charts of curves have been worked out for average speeds of 20, 25, 30, 35, 40, and 45 miles per hour. These are not all reproduced here; but in Fig. 20 the whole group of *speed-time* and *distance-time* curves for this level 1-mile section are reproduced to a small scale. Corresponding groups of curves for distances between stops of 0·5 miles, 2 miles, 4 miles, and 8 miles, are given in Figs. 19, 21, 22, and 23. These charts are very useful for

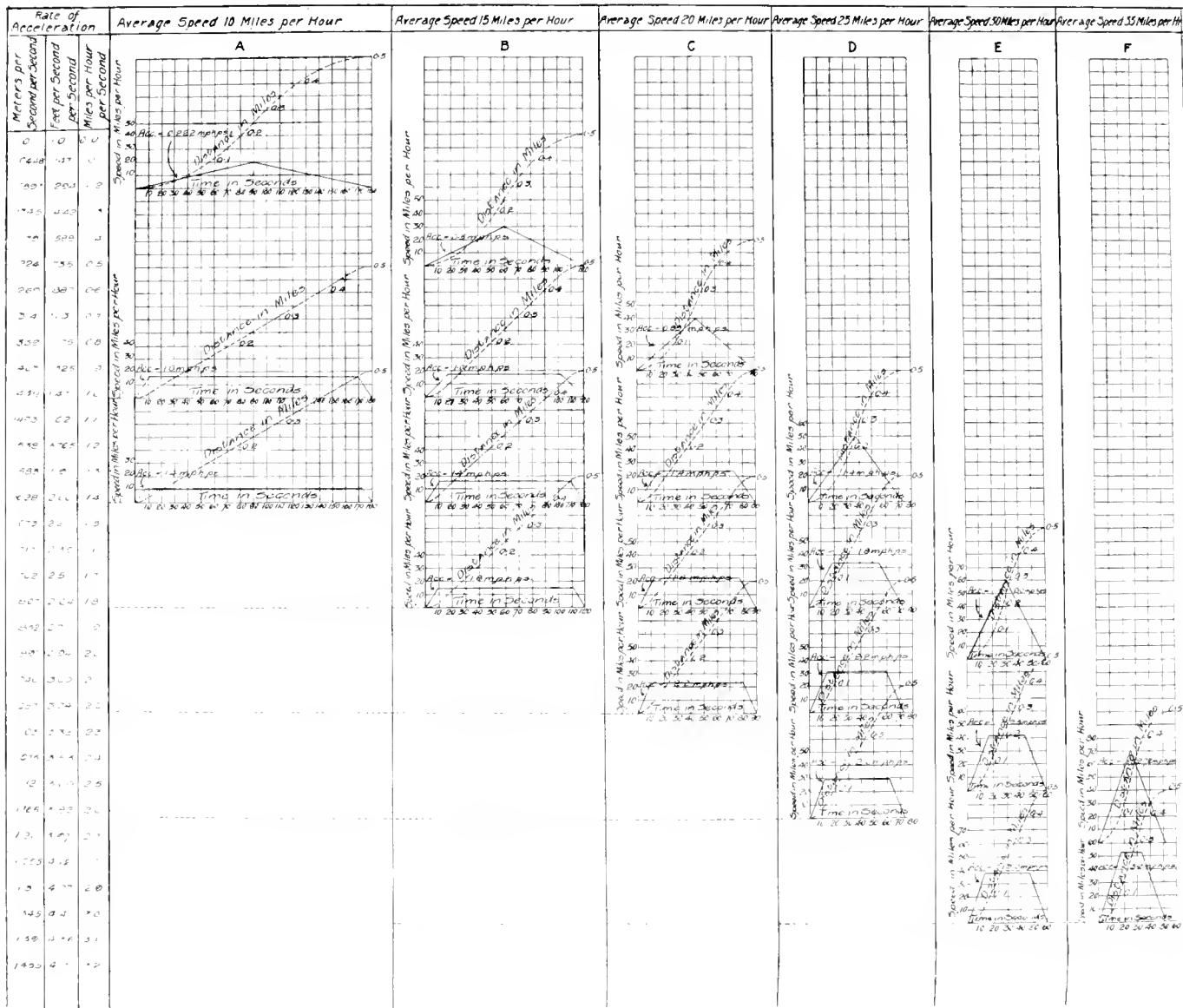
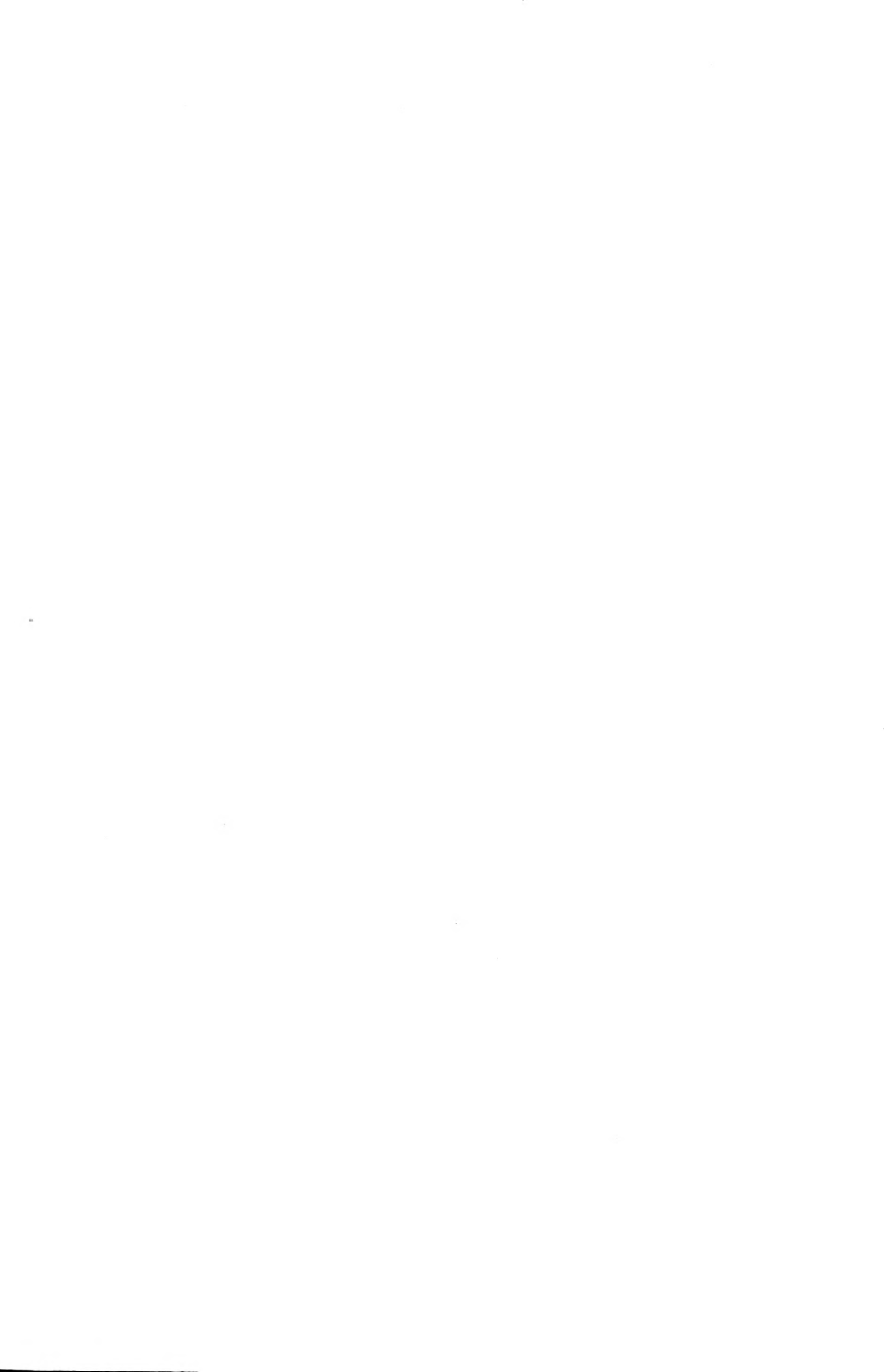

Fig. 19. SPEED-TIME AND DISTANCE-TIME CURVES FOR VARIOUS ACCELERATIONS AND AVERAGE SPEEDS ONE-HALF MILE RUN.



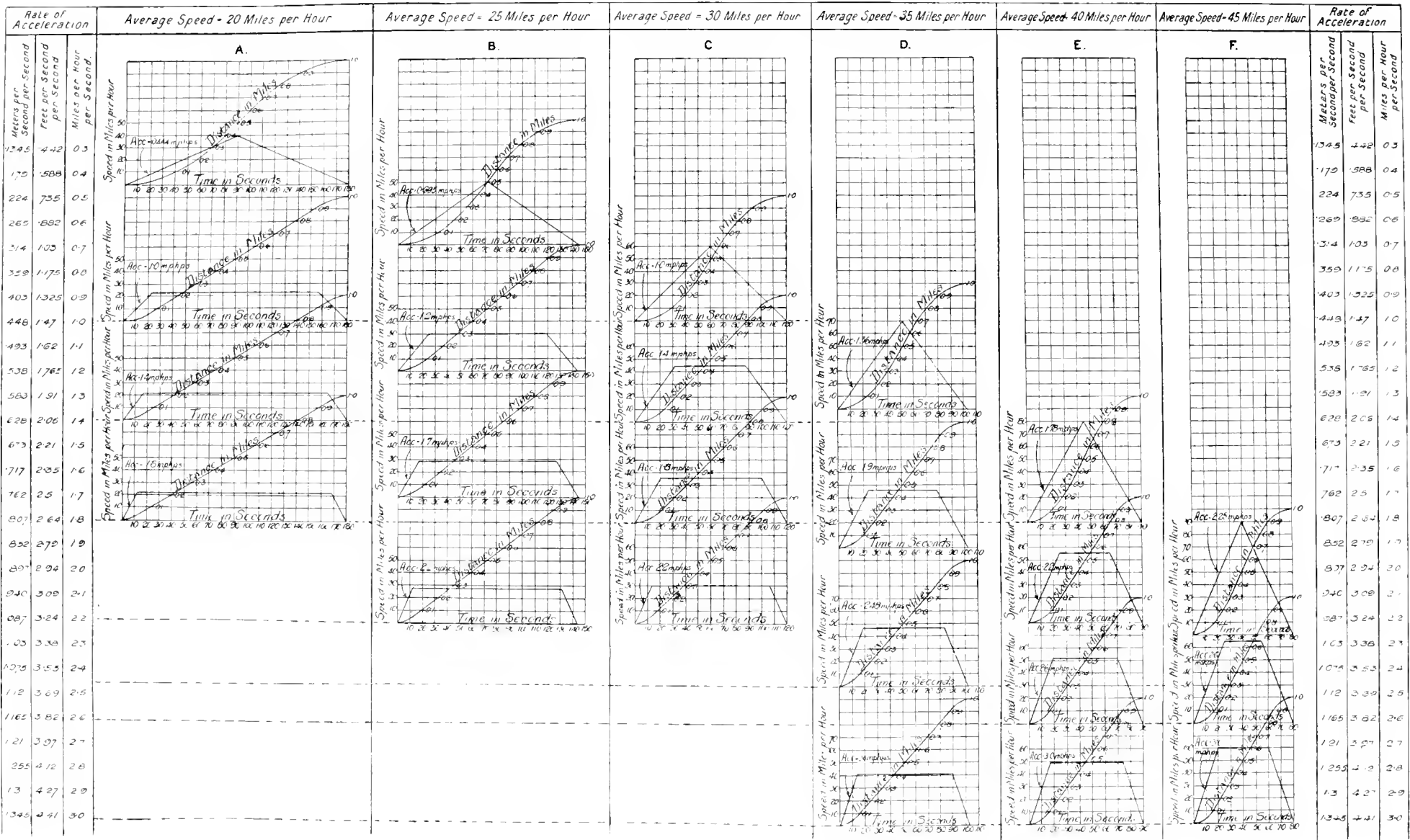

FIG. 20. SPEED-TIME AND DISTANCE-TIME CURVES FOR VARIOUS ACCELERATIONS AND AVERAGE SPEEDS. ONE-MILE RUN.

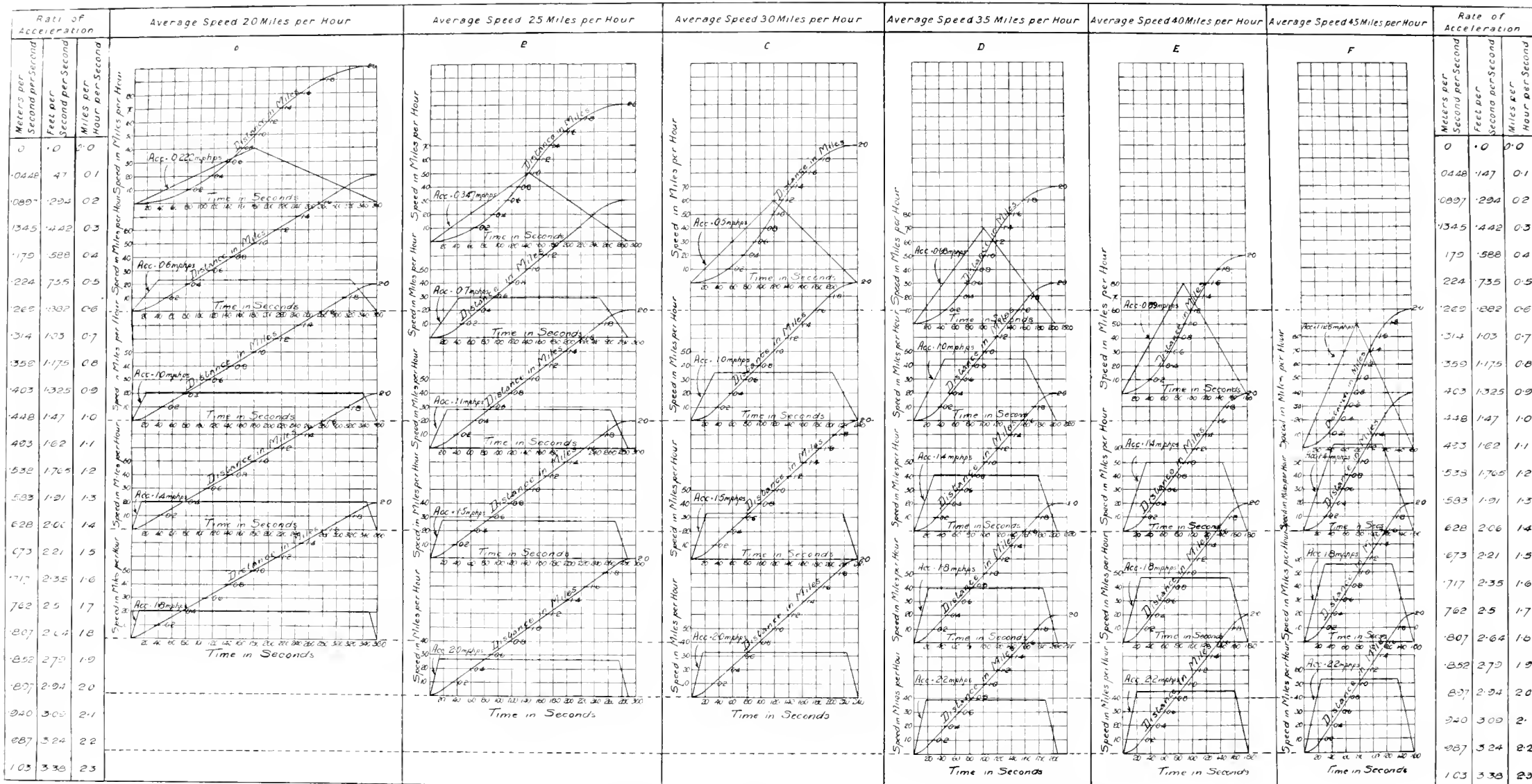

FIG. 21. SPEED-TIME AND DISTANCE-TIME CURVES FOR VARIOUS ACCELERATIONS AND AVERAGE SPEEDS. TWO-MILE RUN.

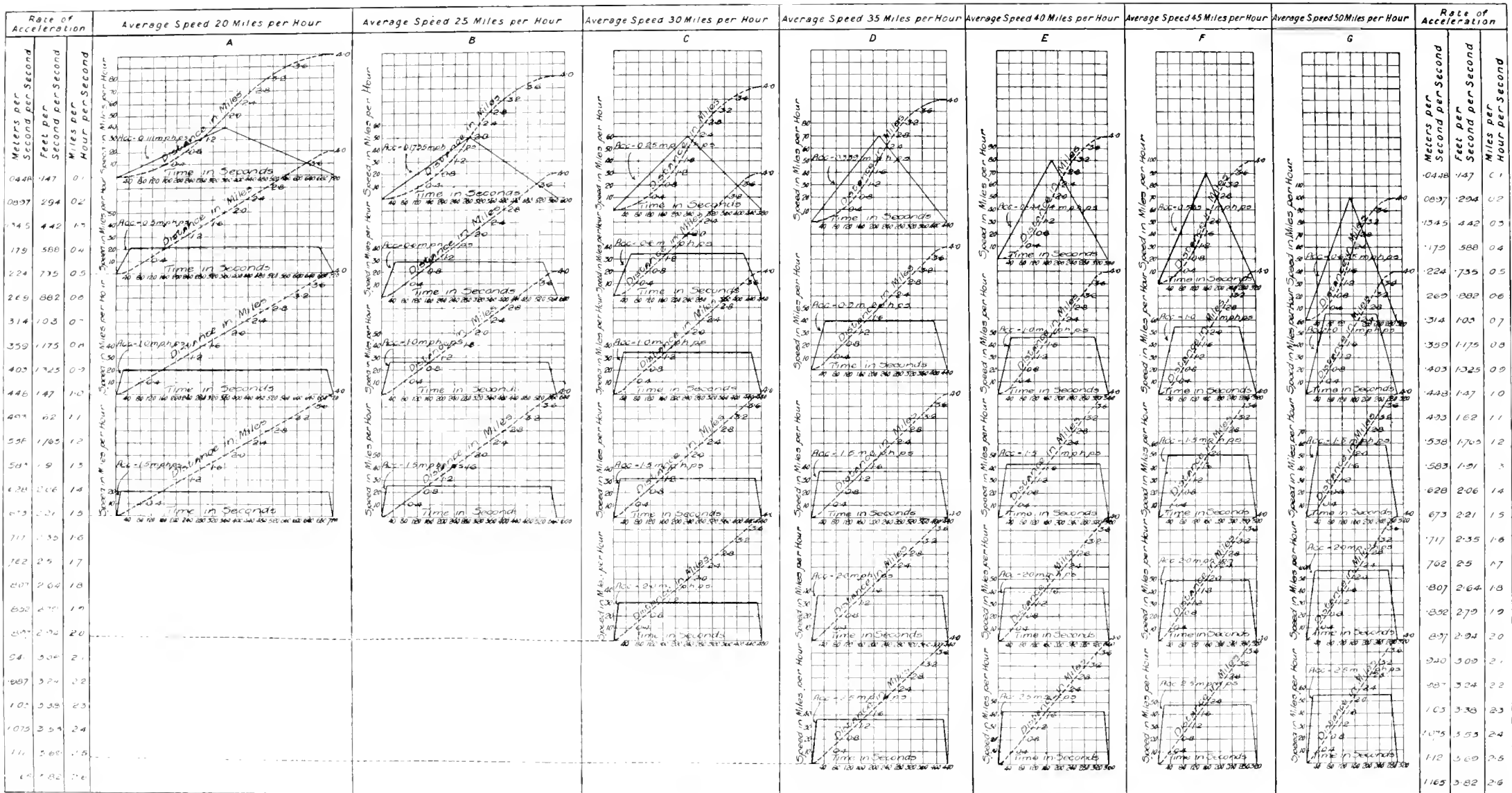
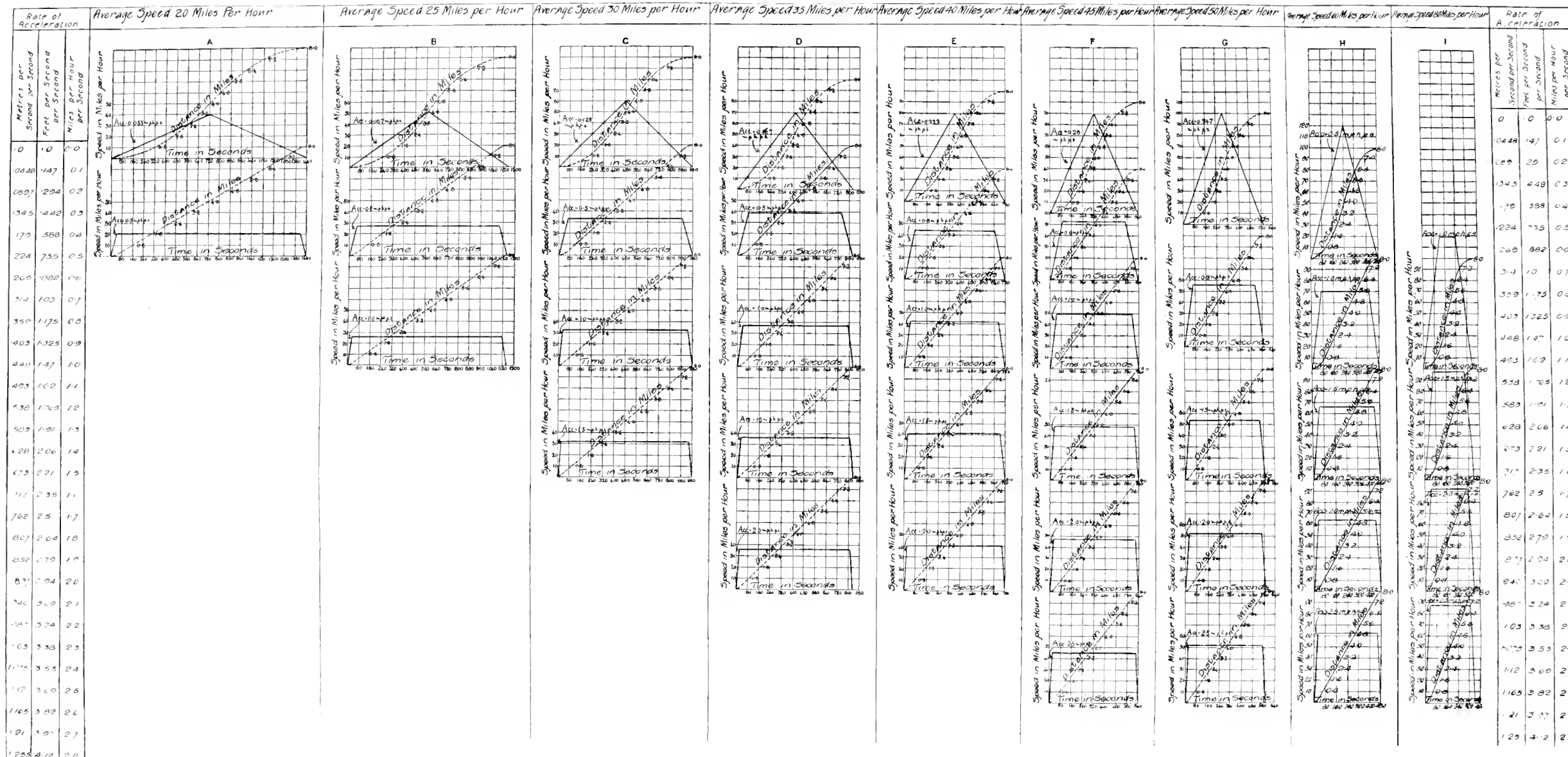

FIG. 22. SPEED-TIME AND DISTANCE-TIME CURVES FOR VARIOUS ACCELERATIONS AND AVERAGE SPEEDS. FOUR-MILE RUN.



Rate of Acceleration	
Metres per Second per Second	Feet per Second per Second
1.0	1.0
0.0448	1.47
0.0097	2.04
1.345	4.42
1.79	5.88
2.24	7.35
2.69	8.82
3.14	10.3
3.59	11.75
4.03	13.25
4.48	14.7
4.93	16.2
5.38	17.65
5.83	19.1
6.28	20.6
6.73	22.1
7.18	23.5
7.62	25
8.07	26.4
8.52	27.9
8.97	29.4
9.42	30.9
9.87	32.4
10.32	33.9
10.77	35.3
11.22	36.8
11.67	38.2
12.12	39.7
12.57	41.2

Rate of Acceleration		
Metres per Second per Second	Feet per Second per Second	Miles per Hour per Second
0	0	0.0
0.0448	1.47	0.1
0.09	3.0	0.2
0.135	4.48	0.3
0.18	5.88	0.4
0.224	7.35	0.5
0.27	8.82	0.6
0.314	10.3	0.7
0.359	11.75	0.8
0.403	13.25	0.9
0.448	14.7	1.0
0.493	16.2	1.1
0.538	17.65	1.2
0.583	19.1	1.3
0.628	20.6	1.4
0.673	22.1	1.5
0.718	23.5	1.6
0.762	25	1.7
0.807	26.4	1.8
0.852	27.9	1.9
0.897	29.4	2.0
0.942	30.9	2.1
0.987	32.4	2.2
1.032	33.9	2.3
1.077	35.3	2.4
1.122	36.8	2.5
1.167	38.2	2.6
1.212	39.7	2.7
1.257	41.2	2.8

FIG. 23. SPEED-TIME AND DISTANCE-TIME CURVES FOR VARIOUS ACCELERATIONS AND AVERAGE SPEEDS. EIGHT-MILE RUN.

ACCELERATION

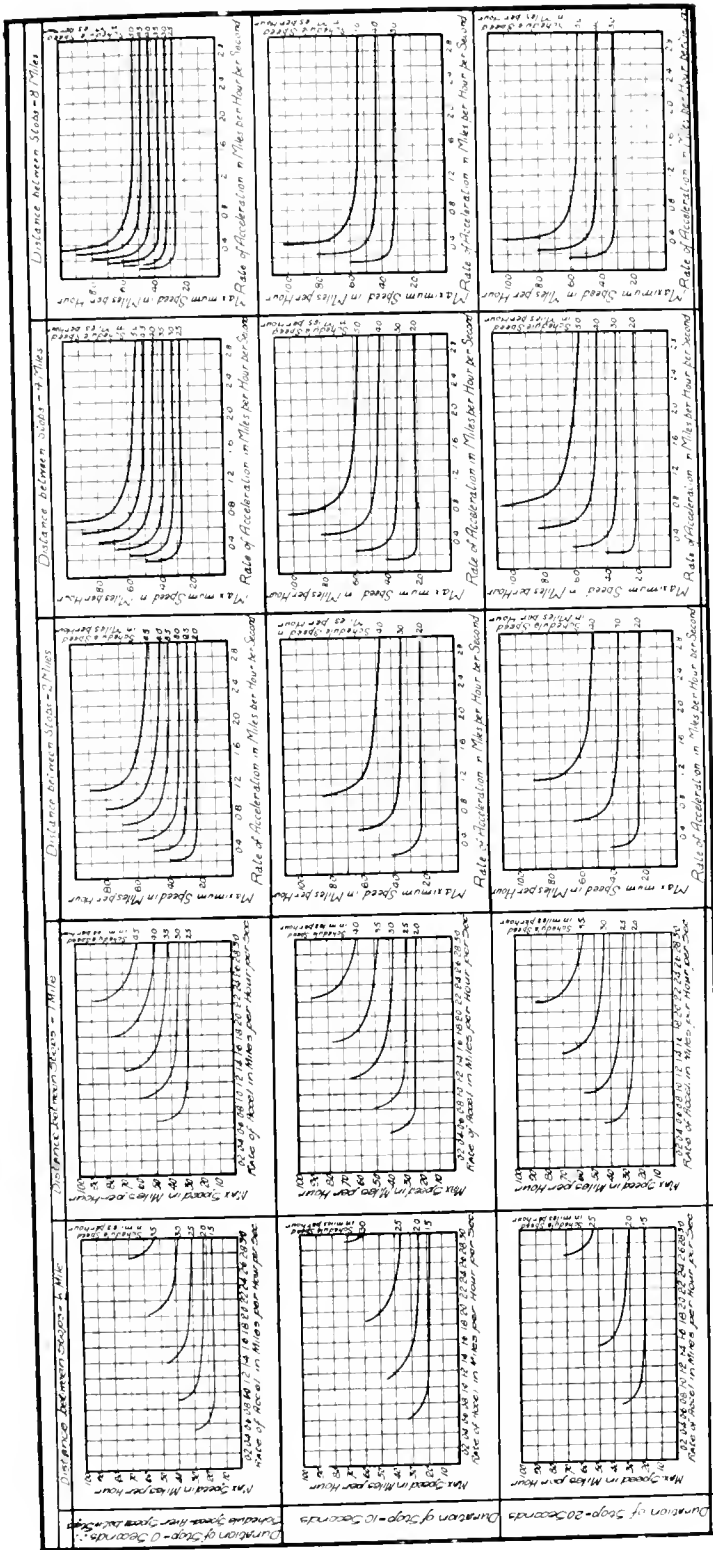

Fig. 24. MAXIMUM SPEEDS FOR DIFFERENT LENGTHS OF SECTIONS AND VARIOUS ACCELERATIONS AND SCHEDULE SPEEDS, AND VARIOUS DURATIONS OF STOP.

ELECTRIC RAILWAY ENGINEERING

reference in practice. They show the conditions and limitations in a way unattainable with mere formulæ. After having determined the suitable running conditions for a given case by reference to charts, it often becomes expedient to resort to formulæ, but this is largely a matter of individual preference. In the initial stages of an investigation, however, the use of charts of this kind is far more instructive than the use of formulæ, and it is a matter for regret that in the limits of a printed page such charts must be on so small a scale as to considerably impair their usefulness.

The five curves of the second group of the upper row in Fig. 24 have been plotted, for a 1-mile section, to show the maximum speeds required for different accelerating rates for average speeds of 25, 30, 35, 40, and 45 miles per hour. By "average" speed we shall in this treatise designate the mean speed *while the train is in motion*, *i.e.*, the mean speed for a run from start to stop. By "schedule" speed we shall designate the mean speed *INCLUDING STOPS*. Thus the five groups of curves in the upper row of Fig. 24 represent the average speeds from start to stop, for various accelerating rates as abscissæ, for runs of half a mile, 1 mile, 2 miles, 4 miles, and 8 miles between stops. These "average" speeds approach more closely to the corresponding "schedule" speeds the shorter the duration of the stops. Thus for stops of 0 seconds duration, *i.e.*, for the limiting case where the train is started off into the next section the instant it is brought to rest after running over a given section, the "schedule" speed becomes equal to the average speed. The second horizontal row of groups of curves in Fig. 24 are calculated on the basis of 10-second stops at stations, and the schedule speed for any given rate of acceleration and for any given length of run between stops is lower than the average speed, and by a rapidly increasing percentage with increasing schedule speed. The lowest horizontal row of groups of curves is calculated for 20-second stops.

These curves bring out very forcibly the limits of attainable "average" and "schedule" speeds. Thus for a 1-mile run between stops an average speed of 45 miles per hour is practically unattainable. The minimum rate of acceleration possible with such a schedule is 2.25 miles per hour per second; and the maximum speed then necessary is 90 miles per hour. Nevertheless, its inclusion in the investigation serves to define the problem.

An "average" speed of 45 miles per hour with one stop per mile, and a duration of 20 seconds per stop, involves a total interval of

$$\frac{45 \times 20}{60} = 15 \text{ minutes}$$

out of every hour during which the train is at rest.

The corresponding "schedule" speed is therefore

$$\frac{60 - 15}{60} \times 45 = 33.8 \text{ miles per hour.}$$

In practice a "schedule" speed of 30 miles per hour with one stop per mile represents the upper commercial limit, and even this "schedule" speed is of doubtful expediency for a route with such frequent stops.

By a comparison of the corresponding curves for 1 mile and half-mile sections it is apparent that a schedule speed of 22 miles per hour is, for a route with half-mile runs, about equivalent, on the score of ultimate possibility, to a schedule speed of 30 miles per hour for a route with 1-mile runs.

The curves of Fig. 25 are drawn to show the minimum accelerating rates possible in order to accomplish given average and schedule speeds over routes

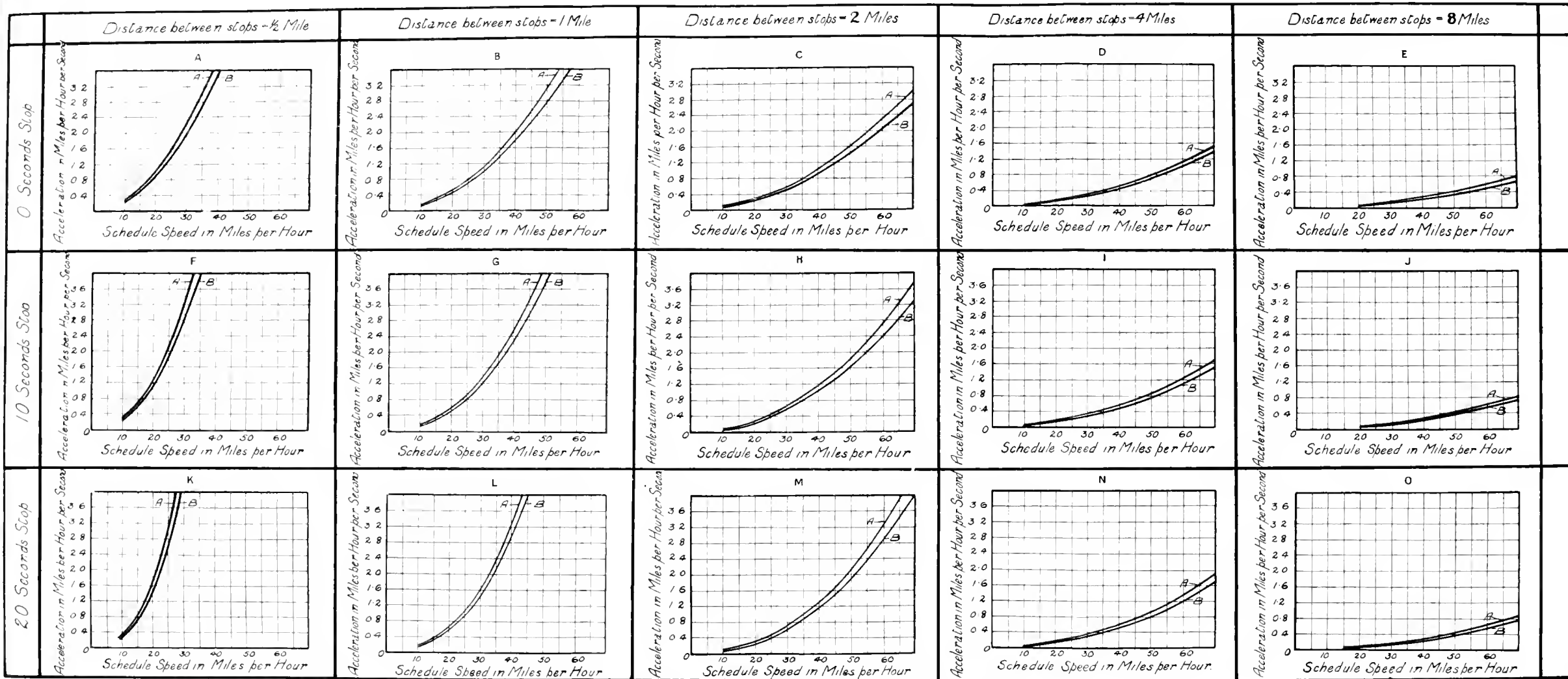

FIG. 25 CURVES OF ACCELERATION AND SCHEDULE SPEED FOR VARIOUS DISTANCES BETWEEN STOPS.

Curve A. Maximum Speed = 1.5 × Average Speed.
 Curve B. Maximum Speed = 2 × Average Speed.



ACCELERATION

composed respectively of sections with lengths of half a mile, 1 mile, 2 miles, 4 miles, and 8 miles from start to stop. From Fig. 25 we see, for example, that with one stop per mile and a limiting acceleration of 1 mile per hour per second the highest theoretically obtainable schedule speed with stops of 0 seconds duration is 30 miles per hour, and the corresponding schedule speed with 20-second stops, is, for the same rate of acceleration, only 25 miles per hour. This rate of acceleration (1 mile per hour per second) would exceed the possibilities of the best steam service, such high rates of acceleration not being practicable with steam-hauled trains of any length. The values given in Table VIII. are deduced from Fig. 25.

TABLE VIII.

Corresponding Schedule Speeds in Miles per Hour for Runs of Following Distances between Stops.

Minimum Rate of Acceleration in Miles per Hour per Second.	½ Mile.			1 Mile.			2 Miles.			4 Miles.			8 Miles.		
	No Stop.	10 Seconds Stop.	20 Seconds Stop.	No Stop.	10 Seconds Stop.	20 Seconds Stop.	No Stop.	10 Seconds Stop.	20 Seconds Stop.	No Stop.	10 Seconds Stop.	20 Seconds Stop.	No Stop.	10 Seconds Stop.	20 Seconds Stop.
0.2	10	9.5	9	14.5	14	13	20	19.5	19	27.5	26	25	40	39.5	39
0.4	13.5	12.5	12	19	18	17	26.5	26	25	38	37	35	55	53	51
0.6	16.5	15	14	23	22	20	33	31.0	30	46	45	43	67	64	62
0.8	19	17	16	27	25	23	37.5	35	34	54	52	50			
1.0	21	19	17.5	30	27.5	26	42	39.5	37.5	60	57	55			
1.2	23	21	19	33	30	28	46	43.5	40.5	65	62	60			
1.4	25	22.5	20	36	32	29.5	49.5	47	43.5						
1.6	27	24	21	38.5	34	31	53	50	46						
1.8	29	25	22	40.5	36	32.5	56.5	52.5	48.5						
2.0	30.5	26	22.8	42.5	38	34									
2.2	32	27	23.6	44.5	39.5	35.5									
2.4	33.5	28	24.4	46.5	41	37									
2.6	34.5	29	25.1												
2.8	35.5	30	25.8												
3.0	37.0	31	26.6												

The three curves of Fig. 26 are derived by taking 90 per cent. of the values of the curves of Fig. 25 for 20-second stops and for maximum speeds 50 per cent. higher than the average speeds. These curves afford approximate loci of the schedule speeds attainable with electric traction for various lengths of run between stops. A braking rate of 2 miles per hour per second is quite permissible. Hence, with continuous current motors, schedules ranging between the two upper curves become practicable so far as relates to the exclusive consideration of speed and time, though they would require very heavy electrical equipments when expressed as a percentage of the total train weight.

With electric traction, it becomes possible to distribute the driving effort amongst the axles of some or all of the carriages, and accelerating rates above 2 miles per hour per second sometimes become practicable; hence, were it not for the question of the instantaneous loads imposed upon the system and the weight of the electrical equipment required to be carried on the train (both of which

ELECTRIC RAILWAY ENGINEERING

limitations will be discussed later¹), schedule speeds of over 30 miles per hour and 20-second stops would be practicable with one stop per mile. Indeed, tests have shown as high an acceleration as 3 miles per hour per second to have been attained by electric traction. A curve is given in Fig. 27 of a run made over a 5,360-foot section with an electric train weighing 65 metric tons and made up of motor-cars without trailers. The average rate of acceleration during

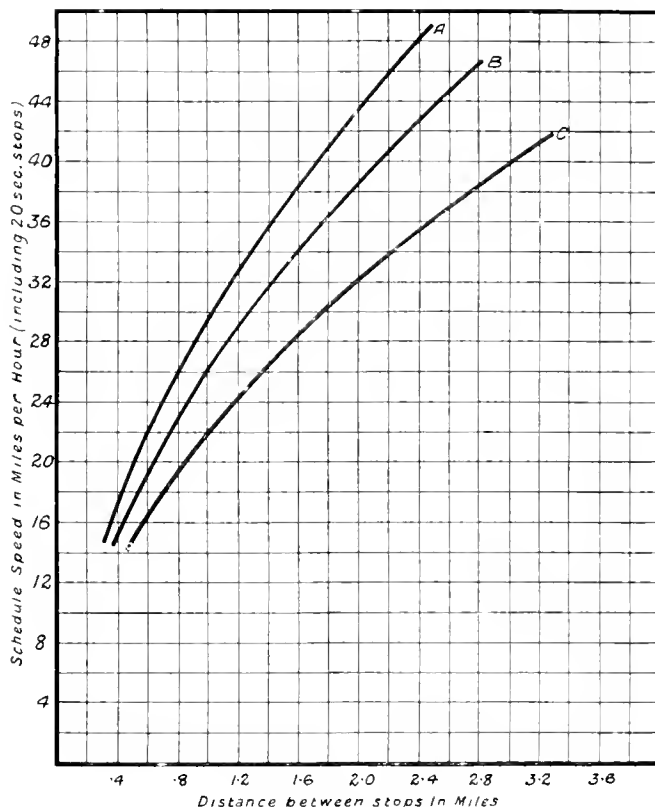

Fig. 26. CURVES OF LIMITING ATTAINABLE SCHEDULE SPEEDS FOR GIVEN MEAN RATES OF ACCELERATION AND BRAKING.

Curve A. - Mean rate of acceleration and braking = 2.0 miles per hour per second
 .. B. " " " " " " = 1.5 " " " "
 .. C. " " " " " " = 1.0 " " " "

the first 5 seconds is seen to be nearly 3 miles per hour per second. This rate of acceleration was, however, not maintained, and the retardation was at a lesser rate; although the maximum speed was 47 miles per hour, the average speed was but 35 miles per hour. This was a very high average speed for so short a section, and it would rarely be practicable to attain it; for, as we shall subsequently show, the amount of power required during acceleration is excessive.

¹ These limitations suffice to prevent the practicability of schedule speeds of over 30 miles per hour with one stop per mile, and even so high a schedule speed with one stop per mile is of doubtful practicability from the commercial standpoint.

ACCELERATION

and the weight of the electrical equipment requiring to be carried on the train is enormous, if the service is to be continuously maintained without undue heating. It is important to note that this is the case, although, could the 3 miles per hour per second accelerating rate be maintained, we see from the curves of Fig. 25 that a 50 per cent. higher average speed (52 miles per hour) would be practicable without exceeding any limitations introduced up to this point of the investigation. Mr. Mordey, in discussing tests on the Liverpool Overhead Railway, has shown that two or three seconds after starting, the accelerating rate reached 28 miles per hour per second.

Turning back to Fig. 24, the general form of the upper curves (*i.e.*, those for average speeds of 45, 40, and even 35 miles per hour) affords evidence, quite aside from the question of power and weight of equipment, of the commercial impracticability of maintaining an average speed of much over 30 miles per hour with one stop per mile.

For the purposes of this general investigation, the diagrams are drawn for

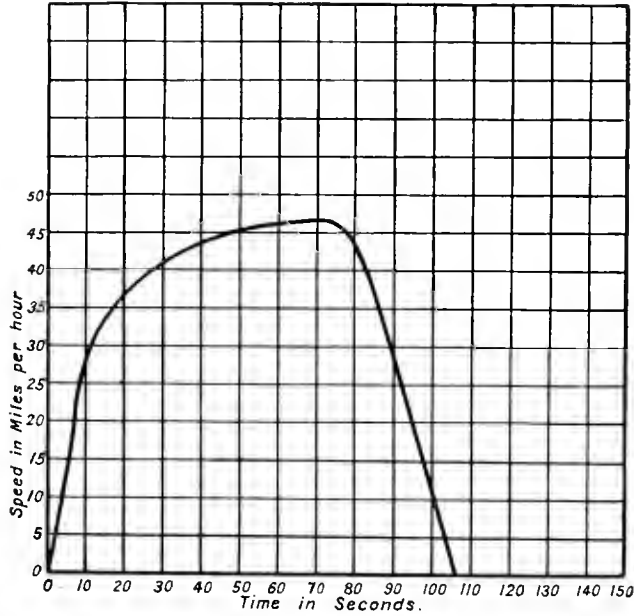

Fig. 27. SPEED-TIME CURVE FOR A 65 (METRIC) TON ELECTRIC TRAIN OF MOTOR CARS (NO TRAILERS).

5,300 foot run power on for 4,080 ft. Watt-hours per ton-mile = 142.—
 "Trans. Am. Inst. Elect. Eng.," Vol. XIX., p. 844.

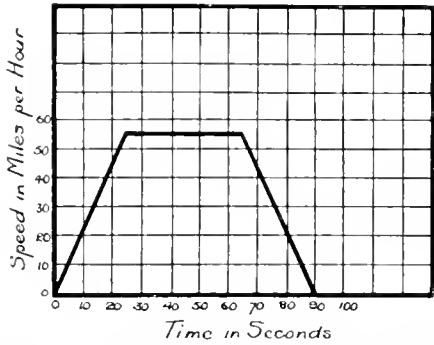

Fig. 28. SPEED-TIME CURVE FOR A CONSTANT ACCELERATION OF 2.2 MILES PER HOUR PER SECOND. AVERAGE SPEED 40 MILES PER HOUR.

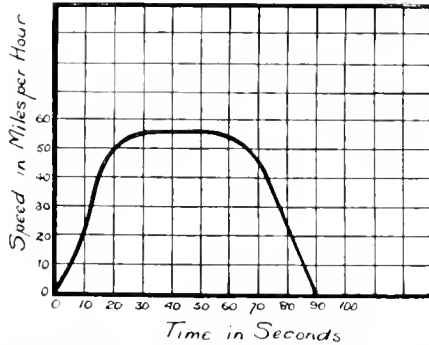

Fig. 29. SPEED-TIME CURVES FOR A MEAN ACCELERATION OF 2.2 MILES PER HOUR PER SECOND. AVERAGE SPEED 40 MILES PER HOUR.

a constant rate of acceleration throughout the accelerating interval. In practice, however, the rate of acceleration is itself variable, being at first rapidly increased to above the average rate and then decreased until constant speed is reached. By

ELECTRIC RAILWAY ENGINEERING

such variation of the rate of acceleration, it is practicable to employ a high average rate of acceleration without undue strain upon the rolling stock and permanent way, and without much discomfort to passengers. This is the more necessary the higher the average rate of acceleration. Thus the curve of Fig. 28, reproduced above, would in reality be replaced by a curve more like that in Fig. 29.

The characteristic of a series motor plays an important part in determining the form of the upper part of the acceleration curve. In the generally employed sense, the acceleration occurs on the "motor curve" from the point where the resistance in series with the motor has finally been completely cut out. From this point onward the speed increases at a slower rate, which is a function of the motor's speed curve, the current falling off as the speed increases, until the watts input falls to the value required to overcome the train resistance at constant speed. It is frequently the case that the resistance is completely cut out before more than two-thirds of maximum speed is reached, and the remaining one-third is run on the "motor curve." The

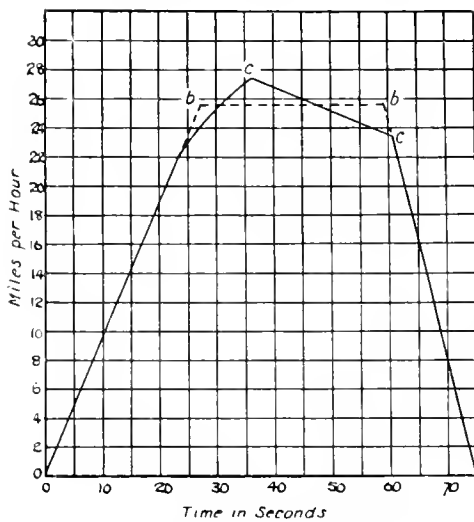

Fig. 30. TO ILLUSTRATE CASE OF RUNNING ON "MOTOR CURVE."

point where operation on the "motor curve" commences is a function of the design of the motor and of the rate of acceleration employed. This must for the present be overlooked, as it would hopelessly involve the preliminary study of the mechanics of electric traction were it necessary to introduce at this stage the varying conditions peculiar to the use of several types of motor, or even to consider the varying characteristics of motors of the same class. The thorough study of this matter of acceleration on the "motor curve" must be taken up at a later stage. The difference introduced in the speed-time curve for the case already illustrated by the diagrams in Figs. 16 and 17 is seen in Fig. 30, where the case of running on the motor curve is shown in the curve $0 c c 75$, which may be compared with the curve $0 b b 75$, drawn

in dotted line, which is reproduced from Fig. 17. As we shall see later, the cycle $0 c c 75$ requires the lowest maximum input and the lowest total input for maintaining the specified service, and it is a point of great economic importance to accelerate on the "motor curve" to the extent permissible with high accelerating rates. For an equipment employing a given design of motor, the higher the initial accelerating rate the sooner will the series resistance be cut out, and the sooner will the point of economical acceleration on the motor characteristic be reached. The average rate of acceleration and the average speed between stops will, however, be the more greatly reduced the sooner the point of acceleration on the motor characteristic is reached.

A few additional groups of speed-time-distance curves have been constructed with a view to showing some striking contrasts occurring as the result of variations in the factors of rate of acceleration, average speed, and distance between stops. In Fig. 31 are shown for an average speed of 40 miles per hour the speed-time (S.-T. and speed-distance (S.-D.) curves for accelerating rates of 1, 2, and 3 miles per hour

ACCELERATION

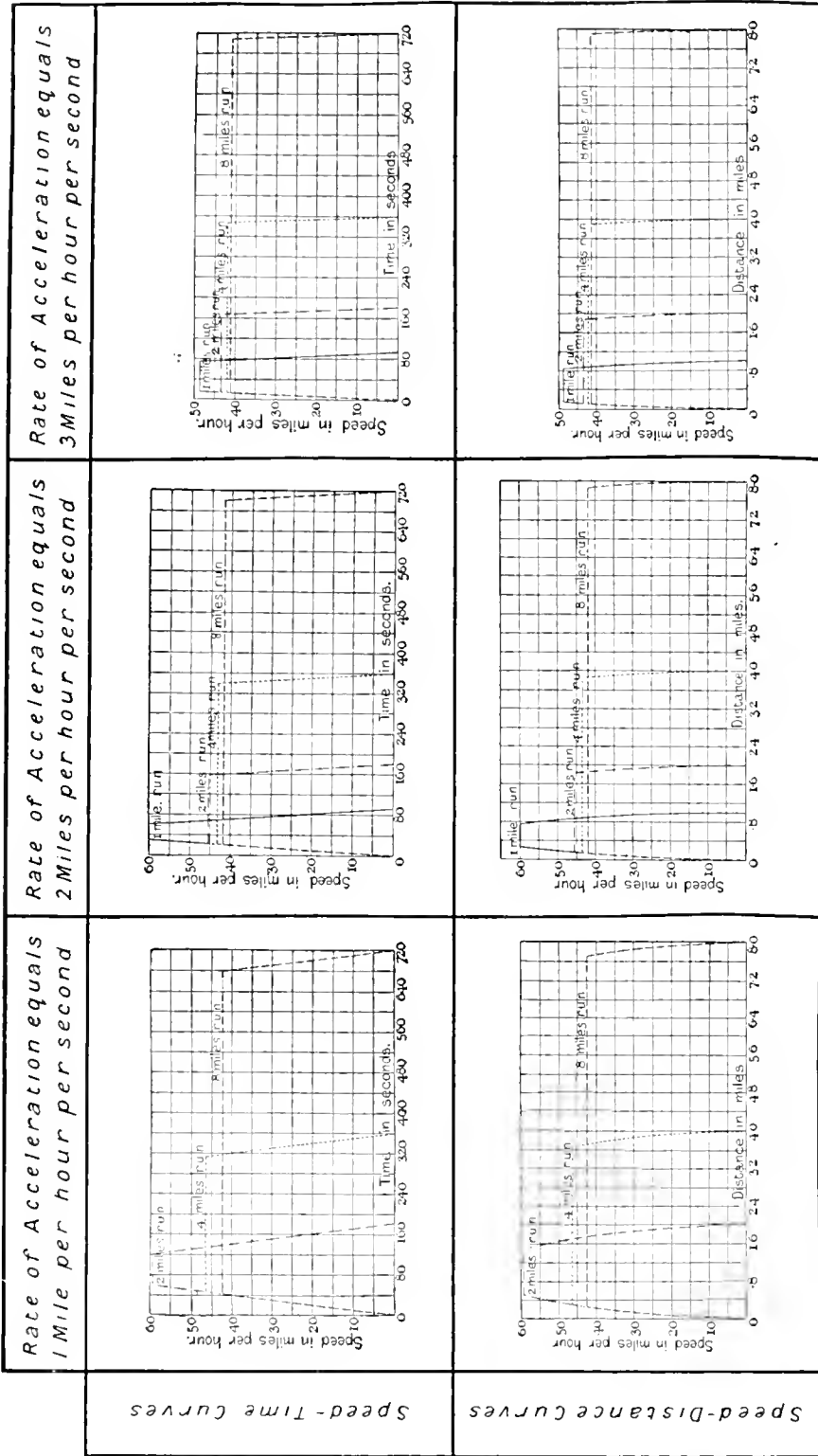

FIG. 31. SPEED-TIME AND SPEED-DISTANCE CURVES FOR AN AVERAGE SPEED OF 40 MILES PER HOUR FOR RUNS OF VARIOUS LENGTHS.

ELECTRIC RAILWAY ENGINEERING

per second. Similar charts for other speeds have been worked out, but are not reproduced in this treatise.

From a comparison of these various curves it is very apparent that the accelerating conditions exert an ever diminishing influence the greater the distance between stops, and the lower the average speed for a given distance between stops. High rates of acceleration are the less necessary or desirable the greater the distance between stops. A large number of useful conclusions may be drawn from curves based on these and similar charts.

In the left-hand vertical column of Fig. 32 are plotted S.-T.-D. curves for an accelerating rate of 2 miles per hour per second, and an average speed of 60 miles per hour, for distances between stops of 2, 4, and 8 miles. While for a stop every 2 miles an average speed of 60 miles per hour is only just possible by calculation at this rate of acceleration, and quite unattainable in practice, it becomes quite practicable with one stop per 8 miles.

In the right-hand vertical column of Fig. 32 are given corresponding curves for an accelerating rate of 3 miles per hour per second, which, as we shall see later, requires too great a consumption of energy during the accelerating period and too heavy an equipment to be commercially practicable.

Both vertical columns of Fig. 33 relate to runs of 4 miles between stops at various speeds. The groups of curves in the left-hand column correspond to an accelerating rate of 1 mile per hour per second, which, while moderate for electric traction, is too high for steam traction; the accelerating rate in the groups of curves in the right-hand column of Fig. 33 is 2 miles per hour per second, which is practicable with electric traction, but is unattainable by steam-hauled trains. Looked at with these facts in mind, the two sets of groups of curves show at a glance the great increase in schedule speed rendered practicable by electric traction, even with such a comparatively long run as 4 miles between stops.

It is evident from the results of our investigation up to this stage that, altogether apart from the energy limitations, there are limitations to the practically attainable schedule speeds, which limitations are the more narrow the shorter the run between successive stops.

We shall now set forth a general method for investigating this matter in any case which may arise, always assuming that the rate of acceleration equals the rate of retardation, that this rate is constant in each case, and that during the time intervening between acceleration and retardation, constant speed is maintained.

We shall designate by—

A the distance from start to stop in feet;

x the time of acceleration in seconds;

T the total time from start to stop in seconds;

V_{max} the maximum speed between stops in feet per second;

V_{av} the average speed between stops in feet per second;

b the rate of acceleration in feet per second per second;

B the minimum rate of acceleration which will carry the train over the distance A in a specified time T, the train being then abruptly brought from the maximum speed to rest by the application of an infinite braking effort.

$$\text{Then } A = \frac{1}{2} BT^2; \therefore B = \frac{2A}{T^2}$$

Rate of Acceleration
equals 2 miles per
hour per second

Rate of Acceleration
equals 3 miles per
hour per second

Speed - Time Curves

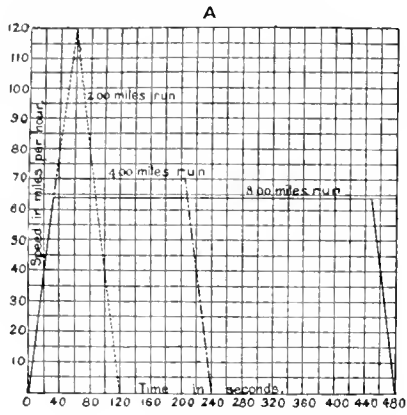

B

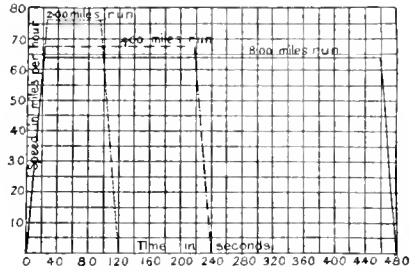

Distance - Time Curves

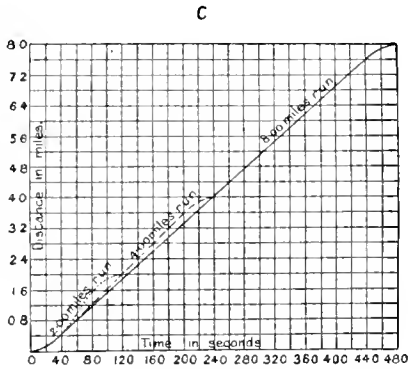

D

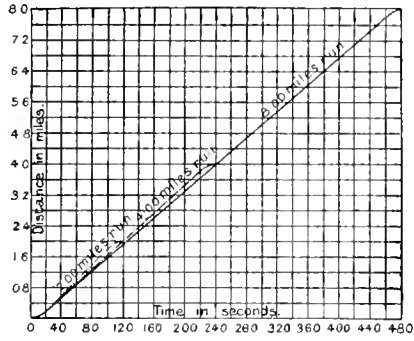

Speed - Distance Curves

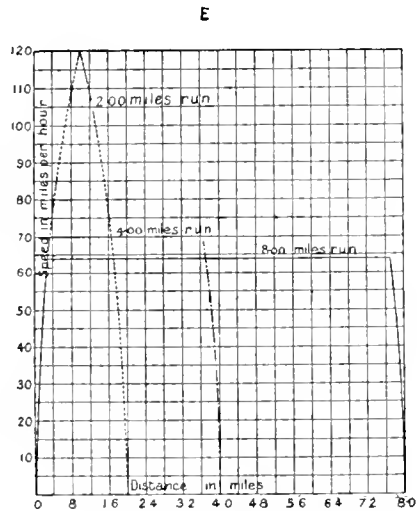

F

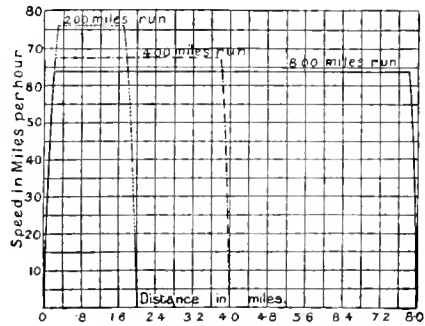
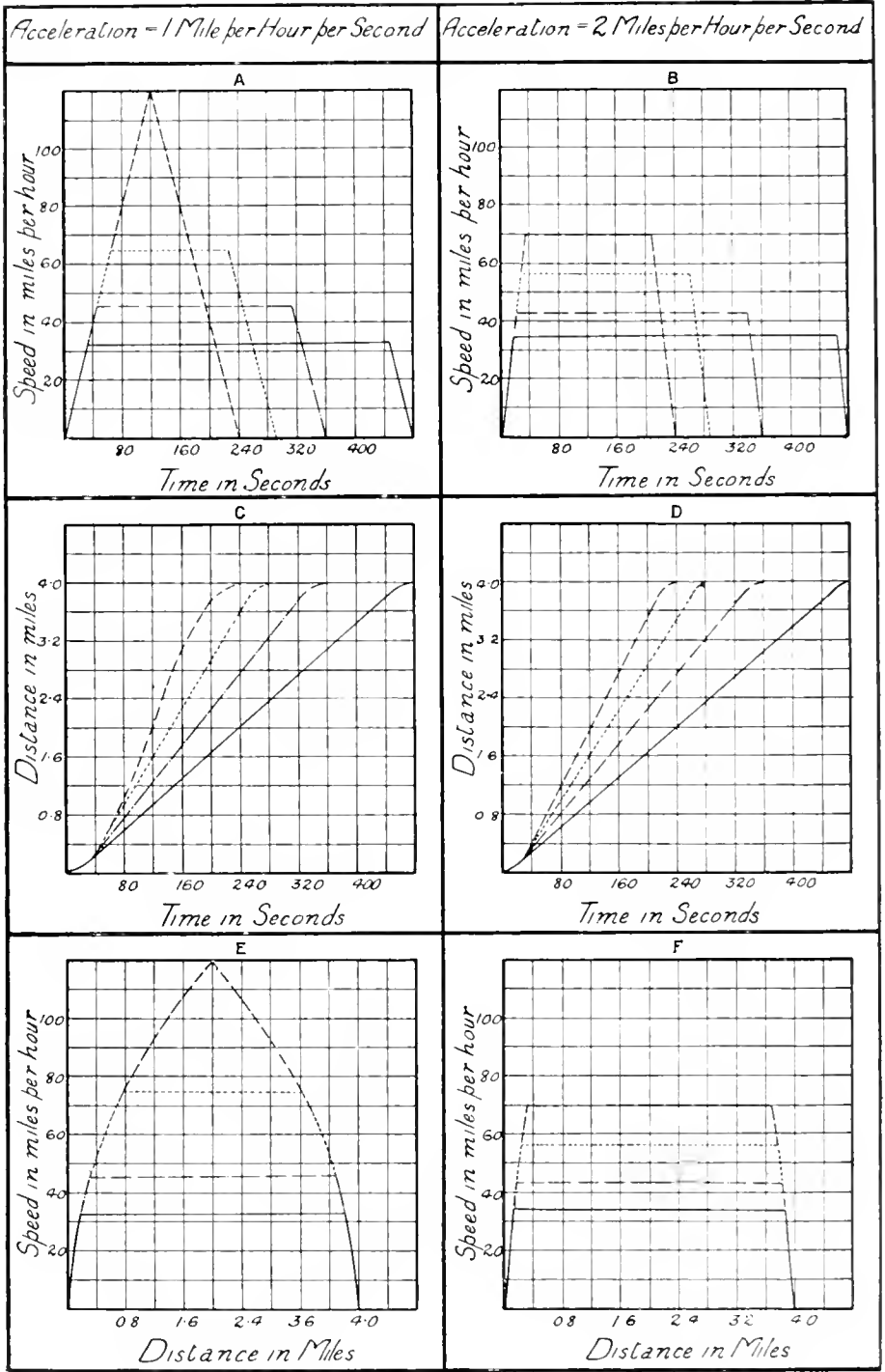

Fig. 32. SPEED-TIME-DISTANCE CURVES FOR AN AVERAGE SPEED OF 60 MILES PER HOUR FOR TWO, FOUR, AND EIGHT MILE RUNS FROM START TO STOP.



Average speed from start to end 30 Miles per Hour ———
 40 ———
 50 ———
 60 ———

Fig. 33. SPEED-DISTANCE-TIME CURVES FOR FOUR-MILE SECTION.

ACCELERATION

If A and T are given, B can be found by means of the curves in Fig. 15. Let $a = \frac{r}{T}$, i.e., a is equal to the fraction of the total time which is devoted to acceleration.

From these premises the two following equations may be derived¹:—

$$\frac{V_{\max}}{V_{av}} = \frac{1}{1-a}; \quad (I.)$$

$$B = \frac{1}{2a(1-a)} \quad (II.)$$

These two equations, I. and II., are correct for all distances A , for all average speeds V_{av} , and for all accelerating rates b . Their use may be simplified by plotting

¹ Equations I. and II. are derived as follows:

We have—

$$A = V_{av} T, \quad (1)$$

and also

$$A = \frac{V_{\max}}{2} x + V_{\max} (T - 2x) + \frac{V_{\max}}{2} r,$$

which simplifies into

$$A = V_{\max} (T - r), \quad (2)$$

From (1) and (2) we have—

$$\begin{aligned} V_{av} T &= V_{\max} (T - r); \\ \frac{V_{\max}}{V_{av}} &= \frac{T}{T - r} = \frac{1}{1 - \frac{r}{T}}. \end{aligned} \quad (3)$$

We also have given—

$$a = \frac{r}{T}; \quad (4)$$

$$\therefore \frac{V_{\max}}{V_{av}} = \frac{1}{1-a},$$

which is Equation I.

We also have—

$$V_{\max} = b \cdot r, \quad (5)$$

or

$$b = \frac{V_{\max}}{r}, \quad (6)$$

but

$$\begin{aligned} V_{\max} &= \frac{A}{T - r}; \\ \therefore b &= \frac{A}{r(T - r)}. \end{aligned} \quad (7)$$

We also have given—

$$B = \frac{2A}{T^2}. \quad (8)$$

From (7) and (8) we obtain

$$b = \frac{T^2}{2r(T - r)},$$

but

$$T = \frac{r}{a} \text{ (from (4))};$$

$$\therefore b = \frac{1}{2a^2} \left(\frac{r}{a} - r \right),$$

or

$$\frac{b}{B} = \frac{1}{2a(1-a)},$$

which is Equation II.

ELECTRIC RAILWAY ENGINEERING

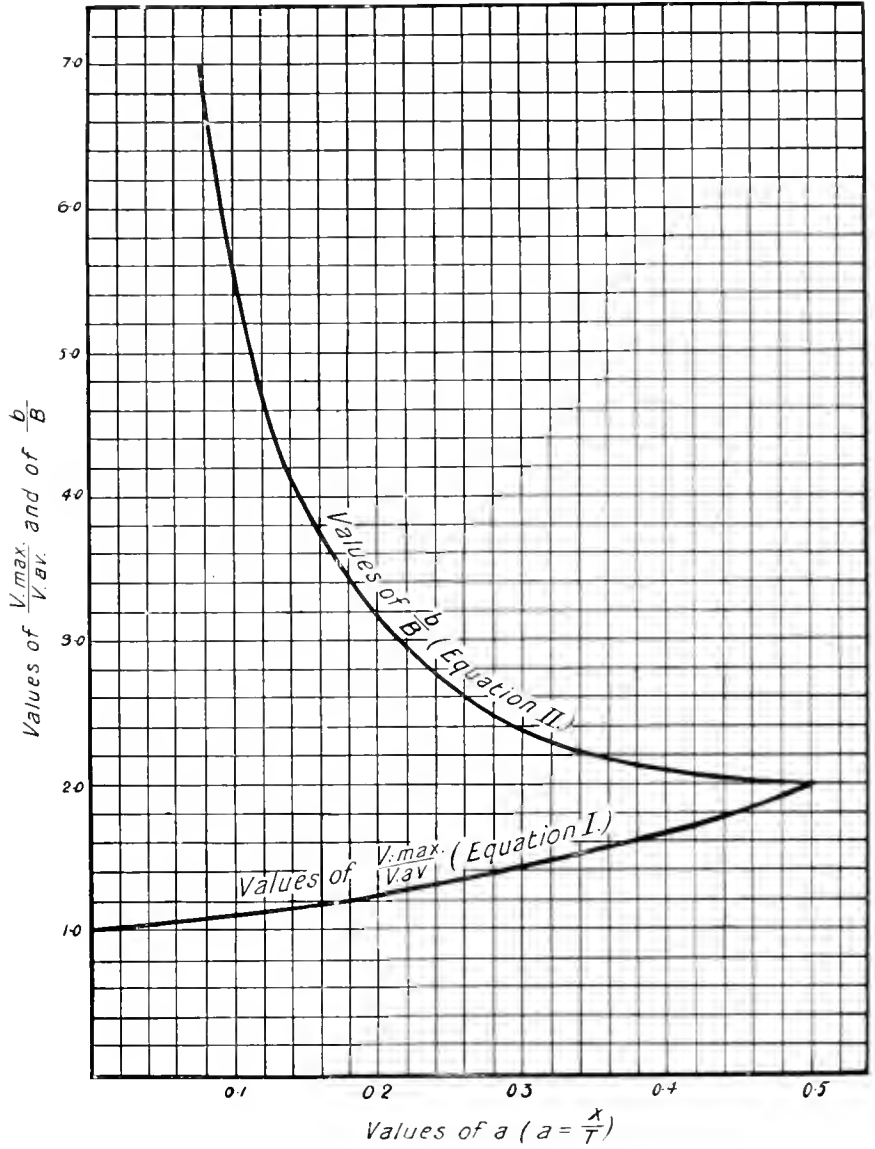

Fig. 34.

them in the two curves, (I.) and (II.), of Fig. 34, with values of a as abscissæ, and with the values

$$\frac{V_{max}}{V_{av}} \text{ and } \frac{b}{B}$$

respectively as ordinates.¹

¹ As $\frac{V_{max}}{V_{av}}$ and $\frac{b}{B}$ are ratios, we may employ the curves of Fig. 34 without reduction from mile or kilometres per hour (as the case may be) to feet per second, or from miles per hour per second to feet per second per second.

ACCELERATION

The use of the curves in Fig. 34 may be best illustrated by means of an example. Given a 1-mile section ($A = 5,280$ ft.), average speed = 30 miles per hour :

$$\therefore T = 120 \text{ seconds.}$$

$$B = \frac{2A}{T^2} = \frac{2 \times 5,280}{120^2}$$

= 0.73 ft. per second per second.

Let us ascertain the maximum speed (V_{\max}) and the minimum rate of acceleration (b) which will be necessary when x equals 18 seconds.

$$a = \frac{x}{T} = 0.15.$$

i.e., the accelerating interval x is 15 per cent. of the total time T from start to stop.

From curves I. and II. of Fig. 34 we find respectively that

$$\frac{V_{\max}}{V_{av.}} = 1.20, \text{ and that } \frac{b}{B} = 3.9;$$

$$\therefore V_{\max} = 1.20 \times V_{av.} = 1.20 \times 30 = 36.0 \text{ miles per hour.}$$

And $b = 3.9 \times B = 3.9 \times 0.73 = 2.85$ ft. per second per second, or 1.95 miles per hour per second.

Suppose, on the other hand, that we want to maintain this same average speed, and that we wish to accelerate and retard at the rate of only 1.5 miles per hour per second. How many seconds will be required for acceleration?

B remains equal to 0.73 ft. per second.

$$b = 1.5 \times 1.47 = 2.20 \text{ ft. per second per second.}$$

$$\frac{b}{B} = \frac{2.20}{0.73} = 3.02.$$

From curve II. of Fig. 34 we find

$$a \left(= \frac{x}{T} \right) = 0.21;$$

$$\therefore x = 0.21 T = 0.21 \times 120 = 25.2 \text{ seconds.}$$

The acceleration will thus occupy 25.2 seconds.

From curve I. of Fig. 34 we find that

$$\frac{V_{\max}}{V_{av.}} = 1.26;$$

$$\therefore V_{\max} = 1.26 \times 30 = 37.8 \text{ miles per hour is the maximum speed required.}$$

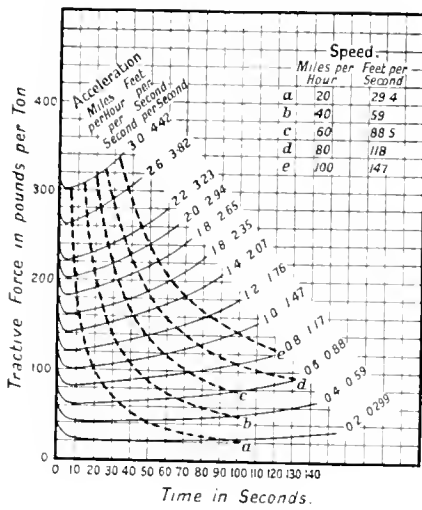

A.- 50-ton train.

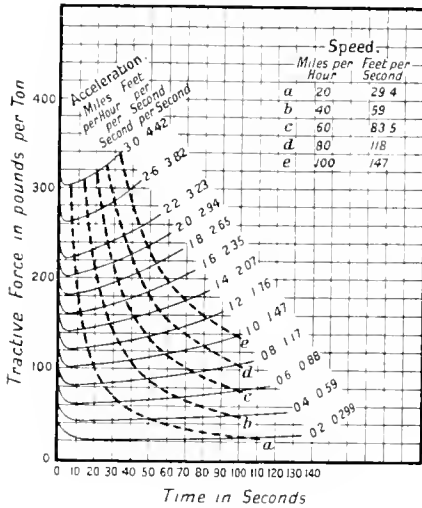

B - 200-ton train

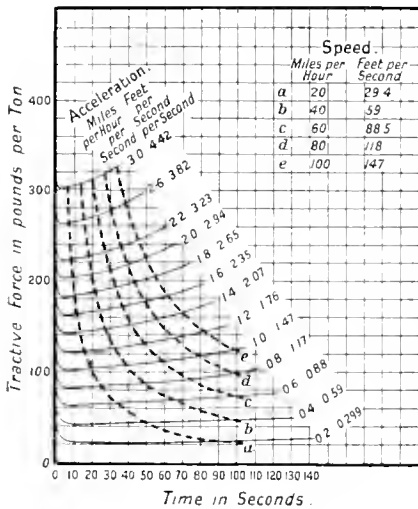

C.- 800-ton train.

Curves shown thus ---- relate to Speed

Figs. 35A, 35B, and 35c. CHARTS SHOWING TRACTIVE FORCE WITH VARIOUS ACCELERATING RATES FOR TRAINS OF DIFFERENT WEIGHTS

Chapter III

THE TRACTIVE FORCE AND THE POWER AND ENERGY AT THE AXLES

UP to this point the relations between speed, distance, and time have alone been considered. The corresponding tractive force must next be discussed.

During acceleration at a constant rate on a level the tractive force is made up of two components, the one constant and a function of the rate of acceleration and the other a variable component and a function of the speed from instant to instant. During operation on the level at constant speed the tractive force is also constant, and is a function of the speed. The tractive force required for acceleration, and corresponding to various rates of acceleration, has already been given in Table VII. To these values must be added the variable tractive force from instant to instant required for overcoming the tractive resistance as the speed increases. The percentage difference which this introduces is a function of the rate of acceleration and of the weight of the train. In Figs. 35A, 35B, and 35c are given curves showing for 50-ton, 200-ton, and 800-ton trains, the tractive force required per ton weight of train to maintain various rates of acceleration during the accelerating period. It is seen that throughout this wide range of train weights (*i.e.*, from 50-ton to 800-ton trains) the variation with the weight is not great, and in order to simplify the calculations we shall, for subsequent work, take as the tractive force per ton during acceleration that corresponding to a 200-ton train as sufficiently correct for all train weights.

Thus the curves of Figs. 36A, 36B, 36c, and

Dotted Curves relate to Speed

Dotted Curves relate to Distance

A.

C.

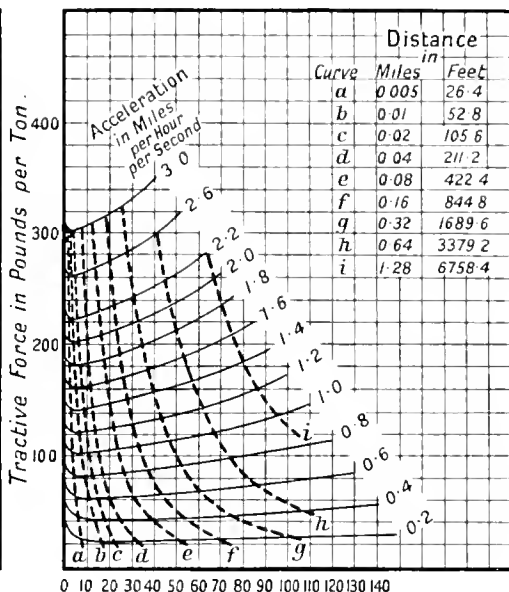
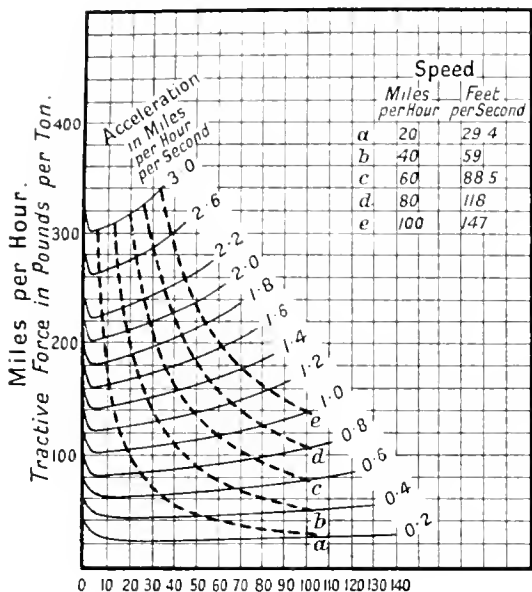

Time in Seconds.

Time in Seconds.

B.

D.

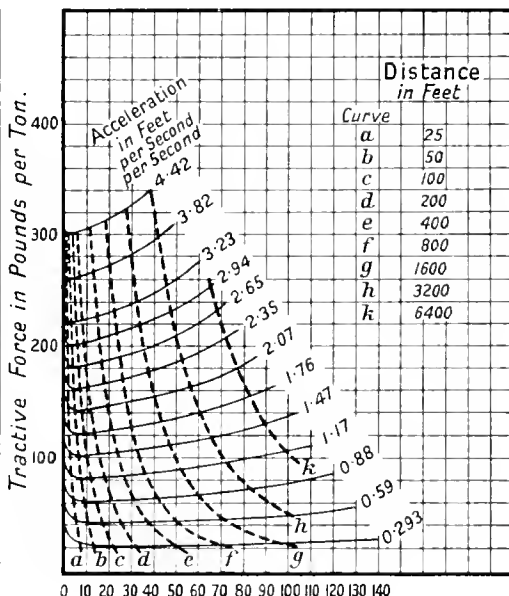
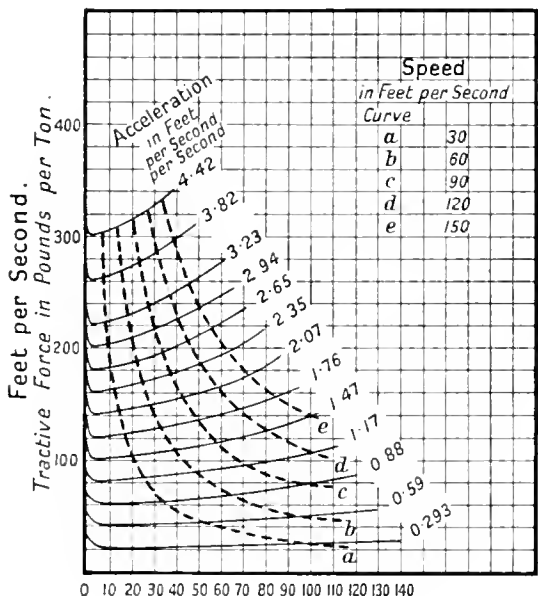

Time in Seconds.

Time in Seconds.

Figs. 36A, 36B, 36C, and 36D. CHART SHOWING TRACTIVE FORCE WITH VARIOUS ACCELERATING RATES FOR 200-TON TRAIN.

ELECTRIC RAILWAY ENGINEERING

36p, which really refer to the tractive force per ton weight of train for a 200-ton train, will be employed for all train weights, and it may be kept in mind that this

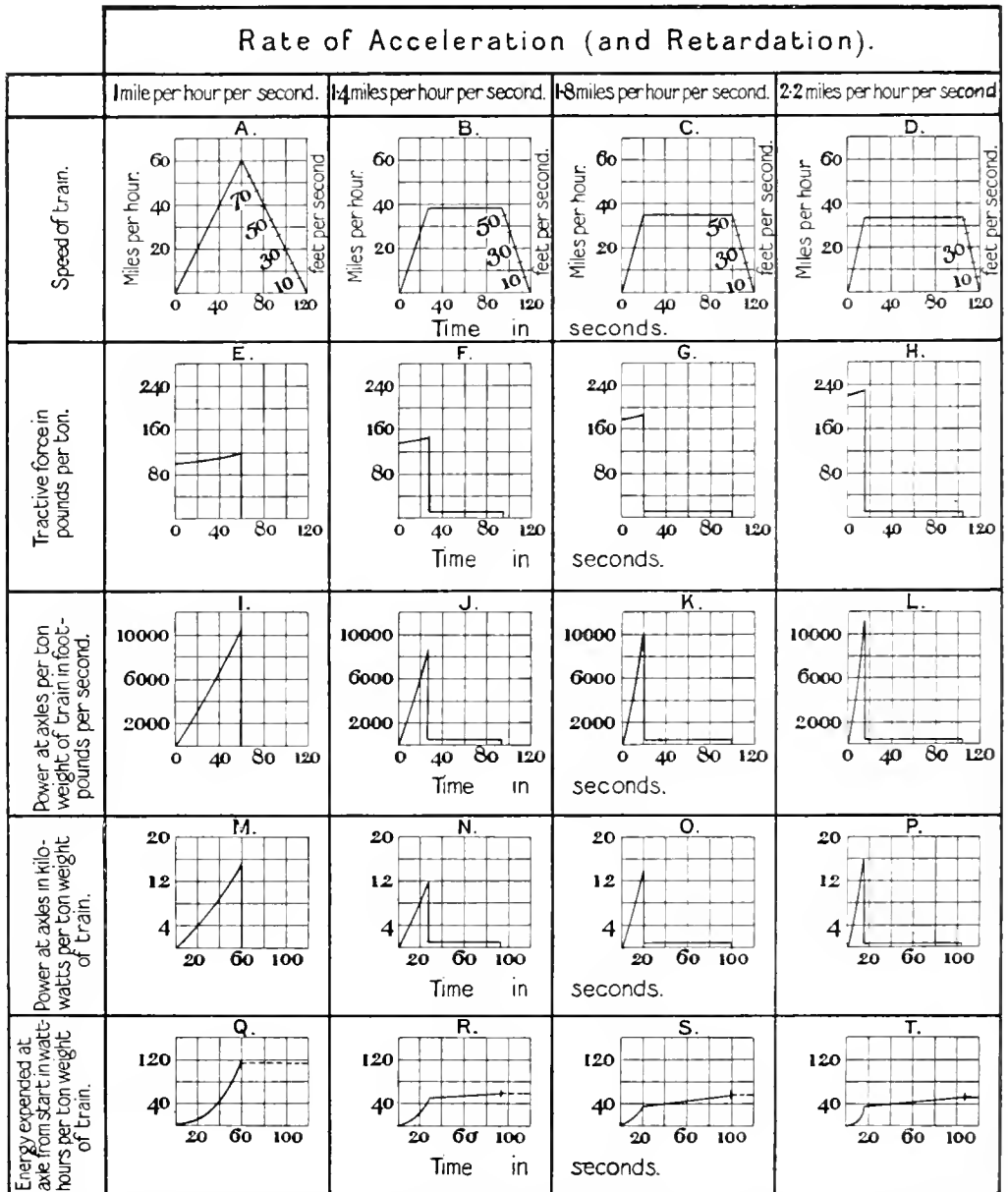

FIG. 37. CURVES OF SPEED, TRACTIVE FORCE, POWER, AND ENERGY AT AXLE. 200-TON TRAIN OPERATED BETWEEN STOPS AT AN AVERAGE SPEED OF 30 MILES PER HOUR WITH ONE STOP PER MILE

gives somewhat too liberal values for long trains and somewhat too low values for short trains.

Let us take the case of a train operating with one stop per mile at an

THE TRACTIVE FORCE AND POWER AT THE AXLES

average speed of 30 miles per hour between stops. Assuming constant rates of acceleration and retardation and a uniform speed from the completion of acceleration to the commencement of retardation, the speed-time curves for accelerating rates of 1.0, 1.4, 1.8, and 2.2 miles per hour per second will be those already given in the curves of Fig. 15 and in the curves of column C of Fig. 20. These curves are repeated in the upper row of Fig. 37. The corresponding tractive force-time curves are given in the second row, the constant speed figures relating to a 200-ton train.¹ The rate of expenditure of energy at the axle, in foot-pounds per second per ton weight of train, is given in the third row. As a kilowatt equals 737 foot-pounds per second, the energy expended in kilowatts at the axle per ton weight of train moved, is readily deduced, and is given in the fourth row of curves. The fifth row of curves shows the total watt-hours at the axle per ton weight of train which, at any given time from the start, have been consumed. Hence the value at the point of cutting off the current represents the watt-hours at the axle per ton-mile for the entire run from start to stop.

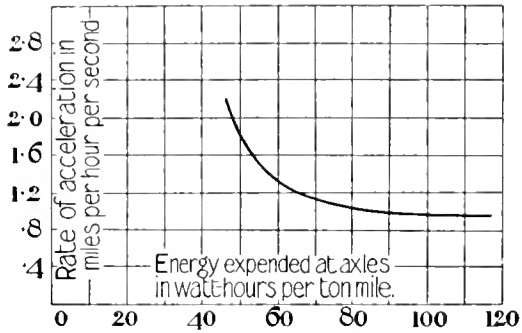

Fig. 38. CURVE OF WATT-HOURS AT AXLES PER TON-MILE FOR 200-TON TRAIN OPERATING WITH ONE STOP PER MILE AT AN AVERAGE SPEED OF 30 MILES PER HOUR BETWEEN STOPS, AND WITH VARYING RATES OF ACCELERATION.

This, for the different rates of acceleration, is as follows:—

TABLE IX.

Consumption of Energy at Axles in Watt-hours per Ton-Mile, One Stop per Mile,

Rate of Acceleration in Miles per Hour per Second,	Watt-hours at the Axles per Ton-mile for a 200-ton Train operated at a Schedule Speed of 30 Miles per Hour between 1-mile Stops.
1.00	117
1.40	57
1.80	50
2.20	47

The results in Table IX. are plotted in the curve of Fig. 38. It is evident that, so far as relates to obtaining a low rate of expenditure of energy at the axles in watt-hours per ton-mile, a high rate of acceleration is desirable. It will be seen later, however, that this may entail an unduly heavy equipment and other disadvantages.

An interesting point to note is that the maximum instantaneous load at the axles required for this average speed of 30 miles per hour between stops and one stop per mile, first decreases with increasing rates of acceleration, and after passing

¹ A representative 200-ton train will be assumed in much of the following discussion. Rough modifications of the results will generally give a basis for sufficiently accurate values for lighter and heavier trains.

ELECTRIC RAILWAY ENGINEERING

through a minimum at a rate of acceleration of about 1.3 miles per hour per second, again increases with higher rates of acceleration. This may be seen from the third and fourth rows of diagrams in Fig. 37, but is more clearly brought out in the curve of Fig. 39.

The average power at the axles in kilowatts per ton weight of train for a 200-ton train operating at an average speed of 30 miles per hour between stops,

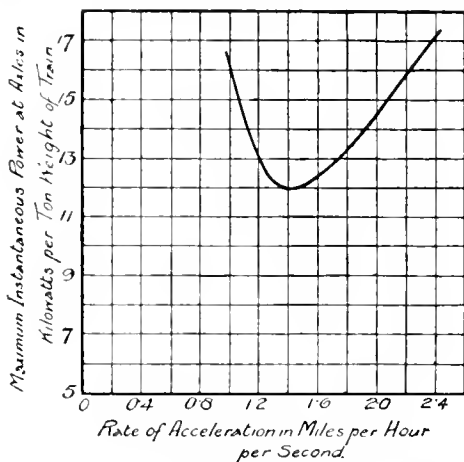

Fig. 39. CURVE OF MAXIMUM INSTANTANEOUS POWER AT AXLES IN KILOWATTS PER TON WEIGHT OF TRAIN, 200-TON TRAIN OPERATED WITH ONE STOP PER MILE AT AN AVERAGE SPEED OF 30 MILES PER HOUR BETWEEN STOPS FOR DIFFERENT RATES OF UNIFORM ACCELERATION. RATE OF RETARDATION TAKEN AS EQUAL TO RATE OF ACCELERATION.

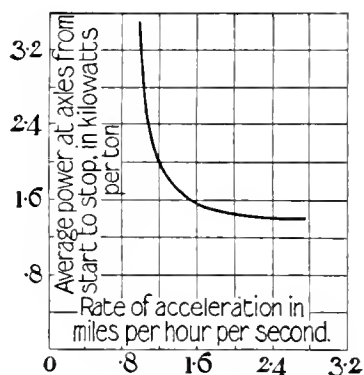

Fig. 40. CURVE OF AVERAGE POWER FROM START TO STOP IN KILOWATTS AT AXLES PER TON WEIGHT OF TRAIN OPERATED WITH ONE STOP PER MILE, AT AN AVERAGE SPEED OF 30 MILES PER HOUR BETWEEN STOPS, FOR DIFFERENT RATES OF UNIFORM ACCELERATION.

and with one stop per mile for these four rates of acceleration, is readily derived from the values in Table IX., and is given in Table X.

TABLE X.

Average Power at Axles in Kilowatts per Ton, One Stop per Mile.

Rate of Acceleration in Miles per Hour per Second.	Average Power at Axle.
1.0	3.50 kilowatts
1.4	1.71 ..
1.8	1.50 ..
2.2	1.41 ..

The results in Table X. are plotted in Fig. 40, and this also is in favour of a high accelerating rate.

For the same schedule speed of 30 miles per hour, but with but one stop per 2 miles, the calculations will be carried out tabularly instead of by diagrams. The steps may be readily followed from Table XI.

As the purpose of these calculations is restricted to setting forth limitations and imparting ideas of the general magnitude of the quantities involved, it would be out

THE TRACTIVE FORCE AND POWER AT THE AXLES

TABLE XI.

Five a run of 2 miles between stops, at an average speed of 30 miles per hour, this table sets forth the calculations of the tractive force (T.F.) power and energy at the axles per ton weight of train for a 200-ton train at various rates of acceleration, the braking giving a rate of retardation equal to the rate of acceleration.

Rate of acceleration	(Miles per hour per second { Feet per second per second	I.	0.50	0.60	1.00	1.40	1.80	2.20
Speed at completion of acceleration, <i>i.e.</i> , maximum speed (from Fig. 24)	{ Miles per hour { Feet per second	II.	0.71	0.88	1.47	2.06	2.61	3.23
Time in seconds occupied by acceleration (III. \div I.)		III.	60	43	35	33	32	31
Time in seconds occupied by entire 2-mile run between stops		IV.	88	63	51.5	48.6	47.0	45.5
Duration in seconds of operation at maximum speed (VI. \div 2 \times V.)		V.	120	71.8	35.0	23.6	17.8	14.1
Tractive force at completion of acceleration in pounds per ton (from Fig. 36A)		VI.	210	240	240	240	240	240
Average tractive force during accelerating period in pounds per ton (from Fig. 36A)		VII.	96	70	170	193	201	212
Tractive force during constant speed run (from Fig. 10, on p. 15)		VIII.	68	70	110	118	186	230
Maximum instantaneous power at axles per ton weight of train at end of accelerating interval	{ In foot-pounds per second (IV. \times VIII.) { In kilowatts ($\frac{XI.}{737}$)	IX.	59	65	105	144	183	235
Average power at axles during acceleration per ton weight of train	{ In foot-pounds per second ($\frac{IV. \times IX.}{2}$) { In kilowatts ($\frac{XIII.}{737}$)	X.	—	11.0	8.6	8.1	7.8	7.5
Power at axles during constant speed operation per ton weight of train	{ In foot-pounds per second (IV. \times VIII.) { In kilowatts ($\frac{XV.}{737}$)	XI.	6,000	4,400	5,650	7,150	8,750	10,500
Energy expended at axles in watt-hours per ton weight of train	{ During acceleration ($\frac{XIV. \times V.}{3.6}$) { During constant speed run ($\frac{XVI. \times VII.}{3.6}$) { Total from start to stop (XVII. + XVIII.)	XII.	8.15	6.90	7.65	9.70	11.9	14.3
Watt-hours expended at axles per ton-mile ($\frac{XIX.}{2}$)		XIII.	2,600	2,050	2,710	3,500	4,300	5,100
Average power at axles in kilowatts for entire run between stops ($\frac{3.6 \times XIX.}{VI.}$)		XIV.	3.53	2.78	3.68	4.75	5.85	6.93
Ratio of maximum to average power at axles (XII. \div XXI.)		XV.	6.93	4.43	4.43	3.93	3.66	3.41
		XVI.	0.91	0.60	0.60	0.53	0.50	0.46
		XVII.	11.8	5.6	3.6	3.1	2.9	2.7
		XVIII.	—	2.5	2.8	2.8	2.8	2.7
		XIX.	11.8	8.1	6.4	5.9	5.7	5.4
		XX.	5.9	4.1	3.2	3.0	2.9	2.7
		XXI.	1.77	1.22	0.96	0.89	0.86	0.81
		XXII.	1.6	1.9	8.0	1.1	1.4	1.8

ELECTRIC RAILWAY ENGINEERING

of place to employ any close degree of accuracy; thus but three, and often only two, significant figures are employed.

In Table XI., by expressions such as "energy expended at the axles" is meant the propelling energy alone. The braking energy expended in virtue of the stored-up energy of the train is, for low rates of acceleration, often a very large percentage of the total energy expended at the axles in propelling the train. A considerable portion of this may be recovered by "regenerative control" methods.

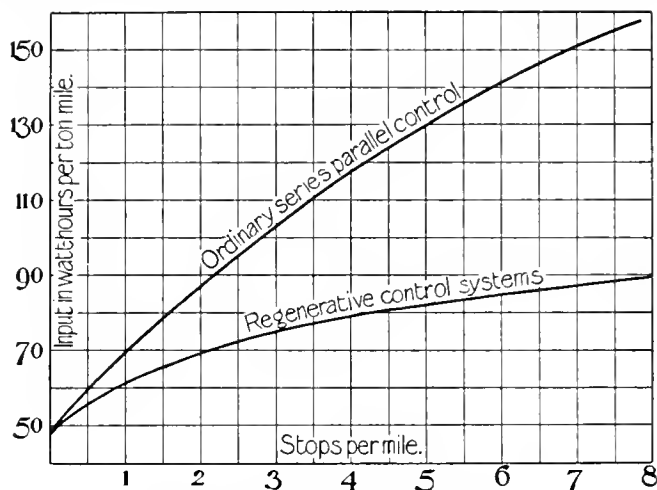

Fig. 11. CURVES FOR TRAMCAR OPERATED ON ORDINARY SERIES PARALLEL AND ON REGENERATIVE CONTROL SYSTEMS.

Basis of calculations:—Weight, loaded car, 11 tons; car friction, 19 lbs. per ton, excluding gearing; motor efficiency, 80 per cent., including gearing; 5-sec. stops; schedule speed, 8 miles per hour; level track.

The amounts involved in the above case of an average speed of 30 miles per hour for a two-mile run from start to stop are shown in Table XII.

TABLE XII.

Recoverable energy per ton mile in percentage of total energy expended at axles per two mile run from start to stop and average speed of 30 miles an hour.

Rate of acceleration in miles per hour per second	I.	0.50	0.60	1.00	1.40	1.80	2.20
Maximum speed, <i>i.e.</i> , speed at completion of acceleration, in miles per hour	II.	60	43	35	33	32	31
Stored-up energy of (In foot-pounds $(32 \cdot 2 \cdot IV)^2$ motion per ton weight of Table XI.) of train at above speed (In watt-hours $(III \div 2,650)$)	III.	265,000	136,000	91,000	80,600	75,500	71,000
Non-recoverable energy at axles in watt-hours per ton weight of train, <i>i.e.</i> , energy wasted in inevitable friction	IV.	100	51	34	30	28.5	27
Non-recoverable energy at axles in watt-hours per ton weight of train, <i>i.e.</i> , energy wasted in inevitable friction	V.	18	5	2	1.1	0.9	0.6
	VI.	0	25	28	28	28	28
	VII.	18	5	2	1.1	0.9	0.6
Total non-recoverable energy in watt-hours per ton-mile (VIII. \div 2)	VIII.	36	35	32	30	30	29
Recoverable energy in watt-hours per ton (IV. \div VII.)	IX.	18	17	16	15	15	14
Recoverable energy per ton-mile (X. \div 2)	X.	82	46	32	29	27.6	26.4
Watt-hours expended at axles per ton-mile (IX. \div XI.)	XI.	41	23	16	15	14	13
Recoverable energy per ton-mile in percentage of energy expended at axles, <i>i.e.</i> , (XI. in per cent of XII.)	XII.	59	40	32	30	29	27
Recoverable energy per ton-mile in percentage of total energy expended at axles, <i>i.e.</i> , (XIII. in per cent of XII.)	XIII.	70%	58%	50%	50%	49%	48%

THE TRACTIVE FORCE AND POWER AT THE AXLES

Item XIII. of Table XII. gives the percentage of *recoverable* energy; this only represents the *recovered* energy on the basis of 100 per cent. efficiency of recovery. Of course, the recovery will be at far less than 100 per cent. efficiency, for the motors must act as dynamos with very variable speed and load, and there will be external waste in controlling the rate of regenerative braking. Assuming that the energy required from the trolley or third rail averages 1.33 times the energy expended at the axles in propelling the train, and that the stored energy is recovered at 66.7 per cent. efficiency, then the percentages of recovered energy for the case analysed in Tables XI. and XII. are as set forth in Table XIII.

TABLE XIII.

Summary of results given in Table XII.

Assumptions are—

Energy input = 1.33 × energy at axles.¹

Mean efficiency of recovery by regenerative braking = 66.7 per cent.

Rate of Acceleration in Miles per Hour per Second.	Energy input to Train in Watt-hours per Ton-mile (1.33 × XII. of Table XII.).	Energy recovered by Regenerative Braking in Watt-hours per Ton-mile (0.667 of XI. of Table XII.).	Percentage of Energy recovered to Energy Input to Train.
0.50	79	27	34 ⁰ / ₁₀₀
0.60	53	15.3	29 ⁰ / ₁₀₀
1.00	43	10.7	25 ⁰ / ₁₀₀
1.40	40	10.0	25 ⁰ / ₁₀₀
1.80	38	9.4	25 ⁰ / ₁₀₀
2.20	36	8.7	24 ⁰ / ₁₀₀

Thus by means of reconverting to electrical energy for return to the line, we may, in the above case, recover some 25 per cent. of the energy input to the train. Of course, this percentage varies greatly, depending chiefly upon the frequency of stops and the schedule speed between stops. In the case of tramway work, it is also greater in a hilly district. While these articles relate to heavy electric traction, it will nevertheless be of interest to give curves based on results obtained in the authors' practice from comparative tests made by them upon tramcars equipped on the regenerative control principle and on the ordinary series-parallel control system. These curves are reproduced in Figs. 41 and 42. From the curves one sees that for relatively low schedule speeds and infrequent stops the advantage of employing regenerative control becomes very slight; and taking into account the greater weight of a regenerative control equipment, the use of such a system would, in certain cases, even be a distinct disadvantage.

On the other hand, a relatively high schedule speed, with frequent stops, permits

¹ This value will vary considerably with the type of equipment, the rate of acceleration, the schedule speed, and the number of stops per mile, and is only taken as a rough value for illustrative purposes.

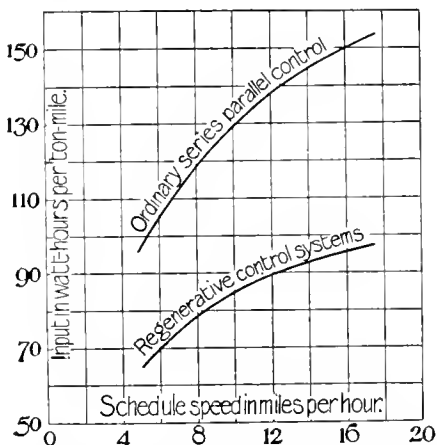

Fig. 42. TRAMCAR RELATIVE INPUTS AT DIFFERENT SPEEDS ON LEVEL TRACK.

Basis for calculation:—Four stops per mile; car weight, loaded, 11 tons; car friction, 19 lbs. per ton; motor efficiency, 80 per cent.; 5-sec. stops.

ELECTRIC RAILWAY ENGINEERING

of much greater advantages from the use of a regenerative control system than is generally realised. In fact, the brief periods of notoriety which these systems enjoy, prior to disappearing from the scene, appear to be in considerable measure attributable to the failure to make exhaustive comparative tests of a character suitable to bring out clearly the considerable advantages which such systems would possess for certain cases. In view of the large amount that is written on this subject of regenerative control, the absence of a thorough recognition

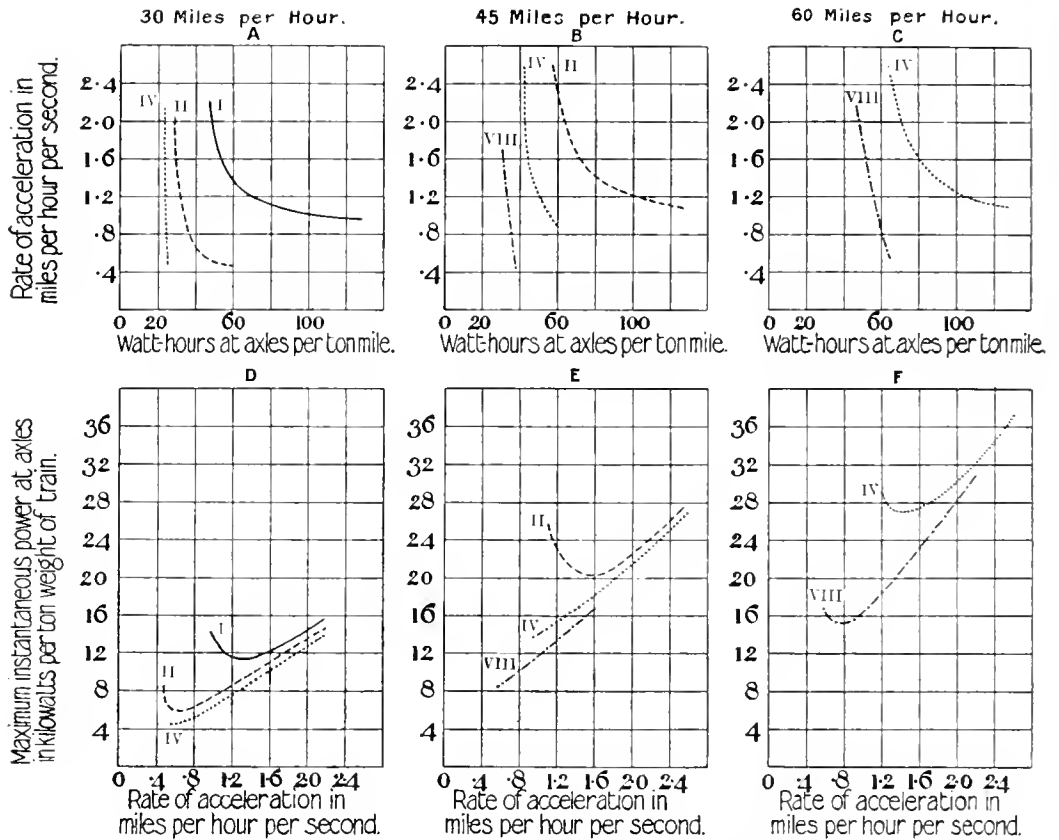

Fig. 43. CURVES OF ENERGY AND MAXIMUM INSTANTANEOUS POWER AT AXLES.

Curves numbered I = One-mile run from start to stop.
 II = Two-mile
 IV = Four-mile
 VIII = Eight-mile

of the real conditions of success or failure forces the authors to conclude that their inventors, or rather the exploiters and their technical staff, have not themselves yet arrived at a clear understanding of the matter.

There is another simple means of reducing the energy input to a certain extent. This consists in "drifting" or "coasting" to the destination, and decreasing the use of brakes, or, in other words, employing the train friction to brake the train. This has already been alluded to on pp. 23 and 27. The method of operation reduces the energy required at the axles, since the train friction is unavoidable, and might as well be employed to reduce the amount of energy required to be stored up in the train.

THE TRACTIVE FORCE AND POWER AT THE AXLES

only to be subsequently wasted at the brake shoes. By modifying the diagrams to take into account the further economy obtainable by substituting a "drifting" stage for the constant speed stage, a moderate reduction may be effected in the watt-hours per ton-mile for very short runs between stops, for the higher rates of acceleration; but for longer runs between stops the result will be relatively but slightly affected. This is also true of the economy attending "acceleration on the motor curve," a discussion of which must be deferred. The use of diagrams based on constant speed running and equal rates of acceleration and retardation has the advantage of giving a better-defined basis for comparison of operation under various conditions as regards schedule speed, frequency of stops, and accelerating rate; it gives results on the safe side of the attainable values. The magnitude of the errors introduced by not taking advantage in these calculations of the further economies of "drifting" and of

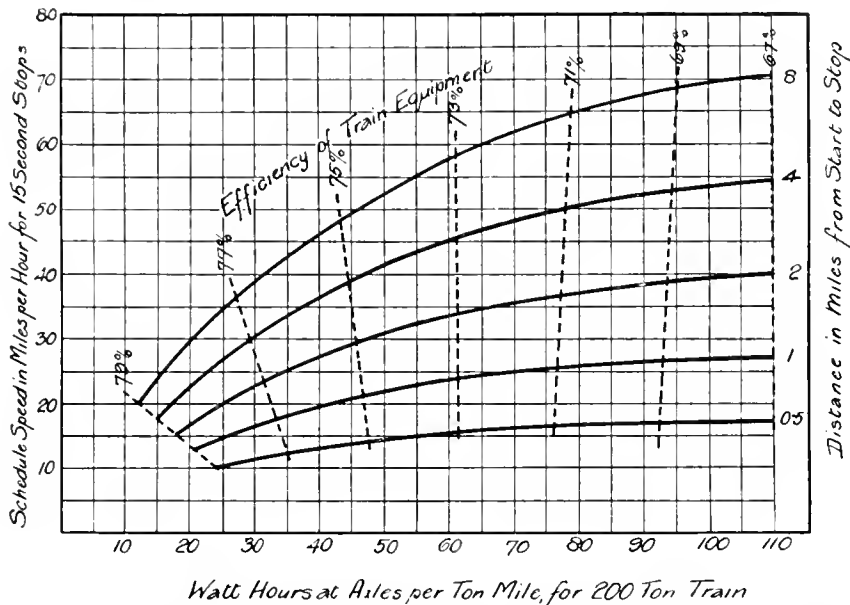

Fig. 44. CURVES OF ENERGY REQUIRED AT AXLES OF 200-TON TRAIN FOR VARIOUS LENGTHS OF RUN AND SCHEDULE SPEEDS.

Assumed mean rate of acceleration and braking = 1 mile per hour per second; level track

acceleration on the motor curve, will be discussed in a later section. "Drifting" has the advantage over regeneration that one avoids the loss of energy involved in reconverting mechanical into electrical energy. Advantage ought to be taken, according to the conditions, of both of these means of securing increased economy.

Calculations on the same lines as those set forth in Table XI. have been made for other speeds and frequency of stops, but it will only be practicable to give the final results as plotted in curves. In the upper row of curves of Fig. 43 is given the energy required at the axles in watt-hours per ton-mile corresponding to various rates of acceleration and to schedule speeds of 30, 45, and 60 miles per hour between stops, and for 1, 2, 4, and 8-mile runs.

In the lower row of curves of Fig. 43 are given, for these same conditions, the values of the maximum instantaneous power at the axles in kilowatts per ton weight of train.

ELECTRIC RAILWAY ENGINEERING

Working from the curves in the upper row of Fig. 43, and limiting the investigation to a mean rate of accelerating and braking equal to 1 mile per hour per second, the full line curves of Fig. 44 are obtained. These curves, for which

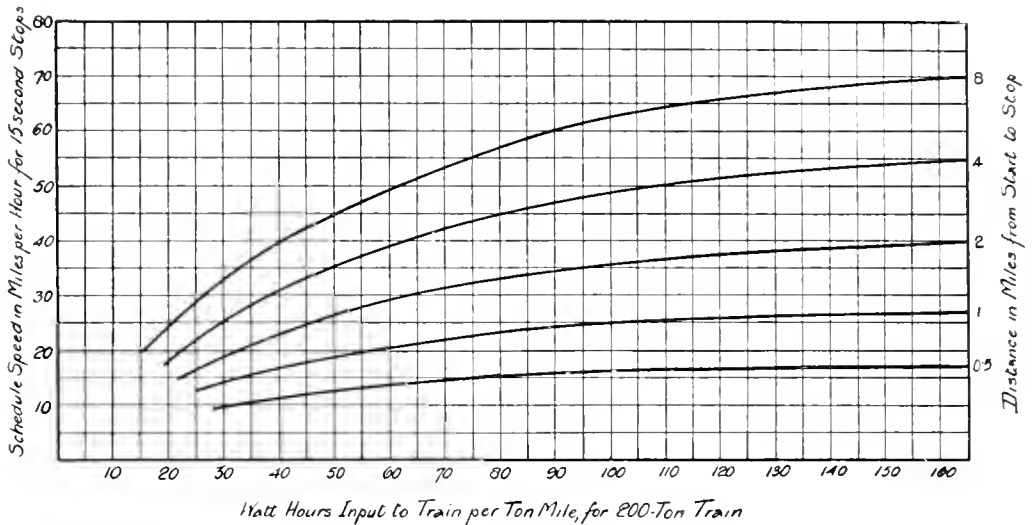

Fig. 45. CURVES OF ENERGY INPUT TO 200-TON TRAIN FOR VARIOUS LENGTHS OF RUN AND SCHEDULE SPEEDS.

Assumed mean rate of acceleration and braking = 1 mile per hour per second; level track.

the stops are taken as of 15 seconds duration, show the relation between schedule speed and watt-hours at axles per ton-mile for a 200-ton train. For lighter trains the energy required at the axles per ton-mile would be slightly greater, and *vice versa* for heavier trains.

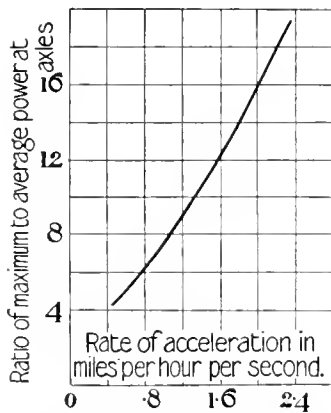

Fig. 46. CURVE SHOWING RELATION BETWEEN THE ACCELERATING RATE AND THE RATIO OF THE MAXIMUM TO THE AVERAGE POWER AT THE AXLES. 200-TON TRAIN OPERATED WITH ONE STOP PER TWO MILES, AT AN AVERAGE SPEED OF 30 MILES PER HOUR BETWEEN STOPS.

With a view to obtaining corresponding values for the total input to the car, the efficiency assumptions indicated by the dotted lines of Fig. 44 have been made. These efficiencies are taken lower the more severe the service, the degree of severity of the service being indicated by the extent to which a curve at the point under consideration has approached the horizontal direction. In general the service is more severe the more frequent the stops for a given schedule speed, or the greater the schedule speed for a given frequency of stops. The more severe the service the greater is the length of time that rheostatic losses are occurring. The efficiency curves are only rough approximations, and may be considered as giving a general idea of the values obtaining in series-parallel control with 600-volt trolley pressure and continuous-current motors.

The results for the watt-hours input to the train per ton-mile as a function of the schedule speed and length of run from start to stop, are, for 15-second stops, given in the curves

THE TRACTIVE FORCE AND POWER AT THE AXLES

of Fig. 45 for a 200-ton train, the mean rate of acceleration and braking being taken at 1 mile per hour per second.

Item XXII. of Table XI. shows the dependence upon the accelerating rate of the maximum to the average power at the axles for the 2-mile run at an average speed of 30 miles per hour. The values are plotted in the curve of Fig. 46. Here we see plainly one of the disadvantages of a high rate of acceleration. It entails equipments of high maximum capacity, and also power-house plant and line with high maximum capacity. The larger the number of equipments in service, the more will the disadvantages of a high ratio of maximum to average capacity be decreased, since the peaks of load of the different equipments will be so distributed as to give, at the power-house, a far lower value for the ratio of maximum to average load. Herein lies one of the great advantages of electric traction; for while, for such a service as that corresponding to the curve of Fig. 46, a steam locomotive would be obliged to provide energy at the axles

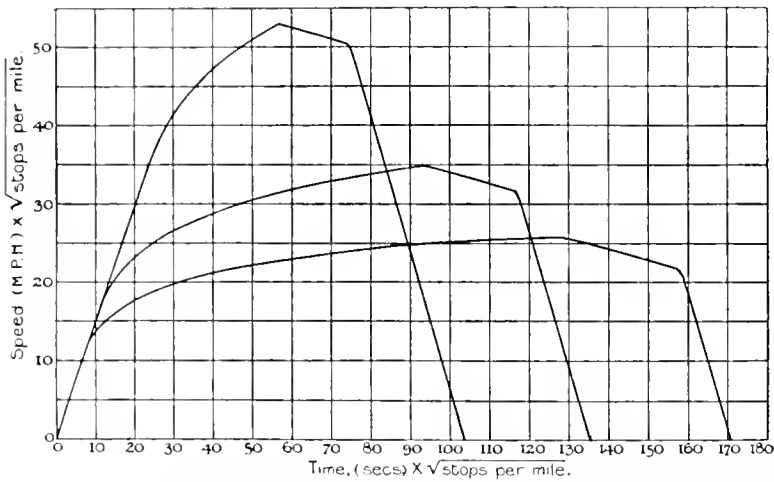

Fig. 47. TYPICAL TRAIN CHARACTERISTIC (S.-T.) CURVES FOR TRAINS OPERATED BY CONTINUOUS CURRENT.

at rates constantly varying through a wide range, an electric service, *with numerous trains fed from a single power-house*, would give a *relatively* constant load on the prime movers at the power-house, and such a number of sets may at any time be placed in service as shall suffice to ensure operation at an economical range of loads.

Again, another reason for operating at low accelerating rates in steam service, is seen from Fig. 46. Were a steam road to operate trains at a schedule speed of 30 miles an hour between stops, and with one stop every 2 miles, the moderate rate of acceleration of 1.4 miles per hour per second would give a ratio of maximum to average load at axles of over 10:1, and would entail very low economy at the locomotive. Somewhat higher rates of acceleration than this, and consequently higher schedule speeds, can, however, generally be economically provided for by electrical operation where a frequent service is employed, since the peaks occasioned by each of the numerous trains will occur at different times, resulting in a *relatively* uniform load on the engines at the power-house, and thus

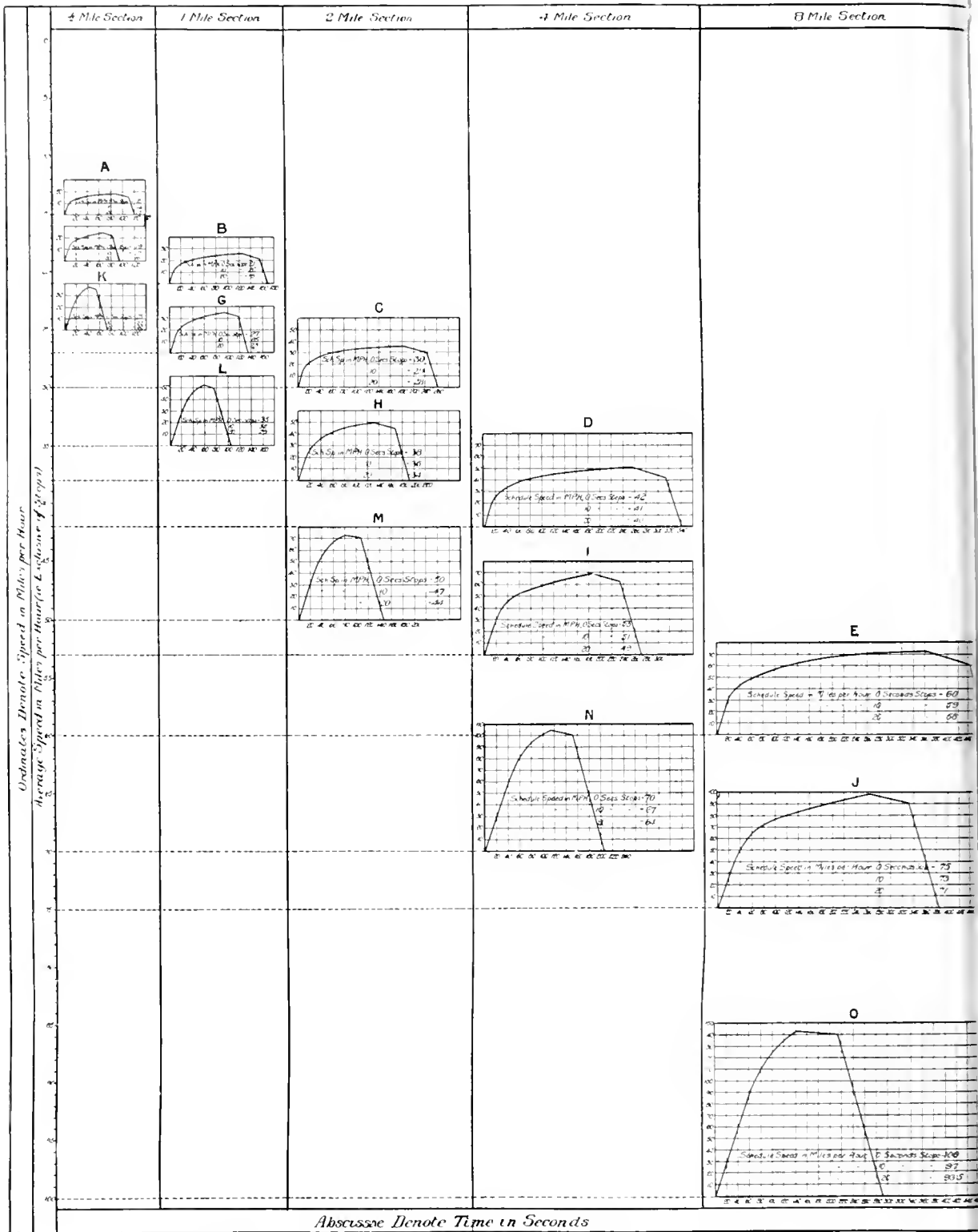

Fig. 48. TYPICAL TRAIN CHARACTERISTIC (S.T.) CURVES FOR CONTINUOUS CURRENT EQUIPMENTS.

THE TRACTIVE FORCE AND POWER AT THE AXLES

permitting of far smaller total steam engine capacity than the sum of the maximum capacities of the numerous locomotives which would be required with a steam locomotive service.

In a recent paper ("Technical Considerations in Electric Railway Engineering," Institution of Electrical Engineers, January 25th, 1906), Carter has published the curves reproduced in Fig. 47, which show typical speed-time curves for trains operated by continuous current. Carter acknowledges that credit is due to Mr. E. H. Anderson for first pointing out this use of a single curve for a number of runs. As it will appeal to many engineers as more useful in rapid work, the authors have developed from Carter's curves, as shown in Fig. 47, the chart of curves given in Fig. 48.

Chapter IV

THE STUDY OF THE CHARACTERISTICS OF ELECTRIC RAILWAY MOTORS AND OF SECTION CHARACTERISTICS AND THE CONSTRUCTION OF LOAD CURVES

IN the vast majority of electric traction undertakings, the continuous-current series motor is employed. A considerable range of variation is possible in the design of this type of motor: the feature which chiefly affects the form of the speed-time curve during the accelerating interval is the degree of saturation of the magnetic circuit.

In the series motor, the field excitation is supplied by the main current, which passes not only through the armature windings, but also through the field magnet windings on its way from the trolley or third rail to the track rails or other return conductor. The excitation is consequently proportional to the input to the motor, and hence also roughly proportional to the load on the motor, and were it not for the saturation of the magnetic circuit and for the internal resistance drop, the speed at constant terminal voltage would be inversely proportional to the amperes input, as shown in curve A of Fig. 49, where, for instance, at 50 per cent. of full load, the speed is double that at full load. In other words, letting I = current input, and letting R.P.M. = speed in revolutions per minute, then, assuming 100 per cent. efficiency and no saturation of the magnetic circuit, we should have for all inputs

$$I \times \text{R.P.M.} = \text{constant.}$$

Thus curve A of Fig. 49 represents the limiting case with decreasing saturation. Now, the other limiting case would be met in a motor with a magnetic circuit reaching complete saturation with an infinitely small current, and incapable of transmitting an increased magnetic flux with increasing current. Obviously, with such a motor, the speed (neglecting the internal I.R. drop) would, for constant terminal voltage, be constant for all loads. The horizontal line B of Fig. 49 is the speed curve for this limiting case. This latter is, in practice, an utterly unapproachable limit; nevertheless the series motors in most extensive use are designed with a highly saturated magnetic circuit at full load current. For a representative motor we shall take the G.E. 66 A., of which over a couple of hundred are in use on the Central London Railway and the Great Northern and City Railway, and many hundreds more on the elevated and underground railways of New York and other American and Continental cities, as well as on the North-Eastern Railway in this country. Some of the characteristic curves of this motor are reproduced in Fig. 50. These curves are based on the employment of a gear reduction of 71 to 18 (or a ratio of 3.94), and on a wheel diameter of 34 ins. For our present purpose we wish to express the speed in terms of the percentage speed at rated full load, and use as

CHARACTERISTICS OF ELECTRIC RAILWAY MOTORS

abscissa the percentage of the output at rated full load. We must digress for the moment to explain the basis of the nominal rating employed for railway motors.

An arbitrary basis of rating for railway motors, which has now been in generally accepted use for a number of years, defines the nominal capacity as the horse-power output, causing 75 degrees Cent. thermometrically determined temperature rise of the hottest accessible part after 1 hour's continuous run on a testing stand at rated voltage. Railway motors in actual service are required to carry an average

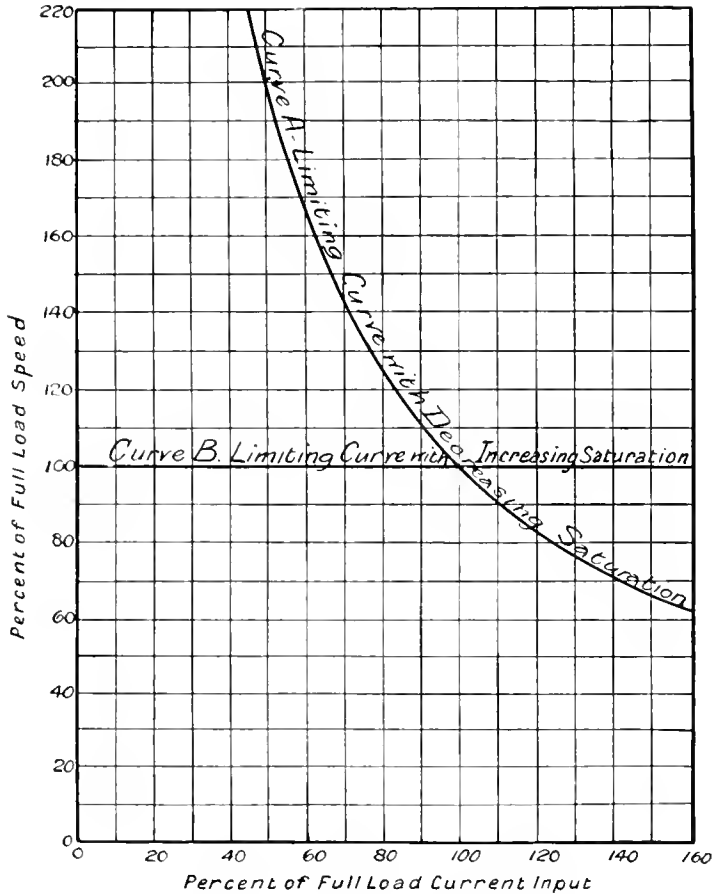

Fig. 49. TO EXPLAIN CONNECTION BETWEEN SPEED AND INPUT OF IDEAL SERIES MOTORS.

load of only some 25 per cent. or less of their rated load, and this shows the great importance of designing them for high efficiency at light loads.¹ Moreover, they are inherently capable of being proportioned to give this result, for the loss in field excitation, instead of being, as in shunt motors, a component of the "no load" loss, increases from a negligibly small amount at no load, with the square of the load, and hence is a component of the so-called "variable losses." In motors for light work, however, the gearing loss comes in and increases the "no load" losses considerably; but large, direct-connected series motors are inherently of very high efficiency at light

¹ "The continuous capacity of railway motors (*i.e.*, the load they can take continuously) may be taken as approximately one-fourth of the commercial rating."—Carter, "Some Notes on High-speed Electric Railway Work" (paper read before the Rugby Engineering Society December 1st, 1904).

ELECTRIC RAILWAY ENGINEERING

loads. These considerations have reference exclusively to motors and gearing; but it should be kept in mind that series motors require auxiliary controlling apparatus in which, when starting, very considerable losses take place in external resistances

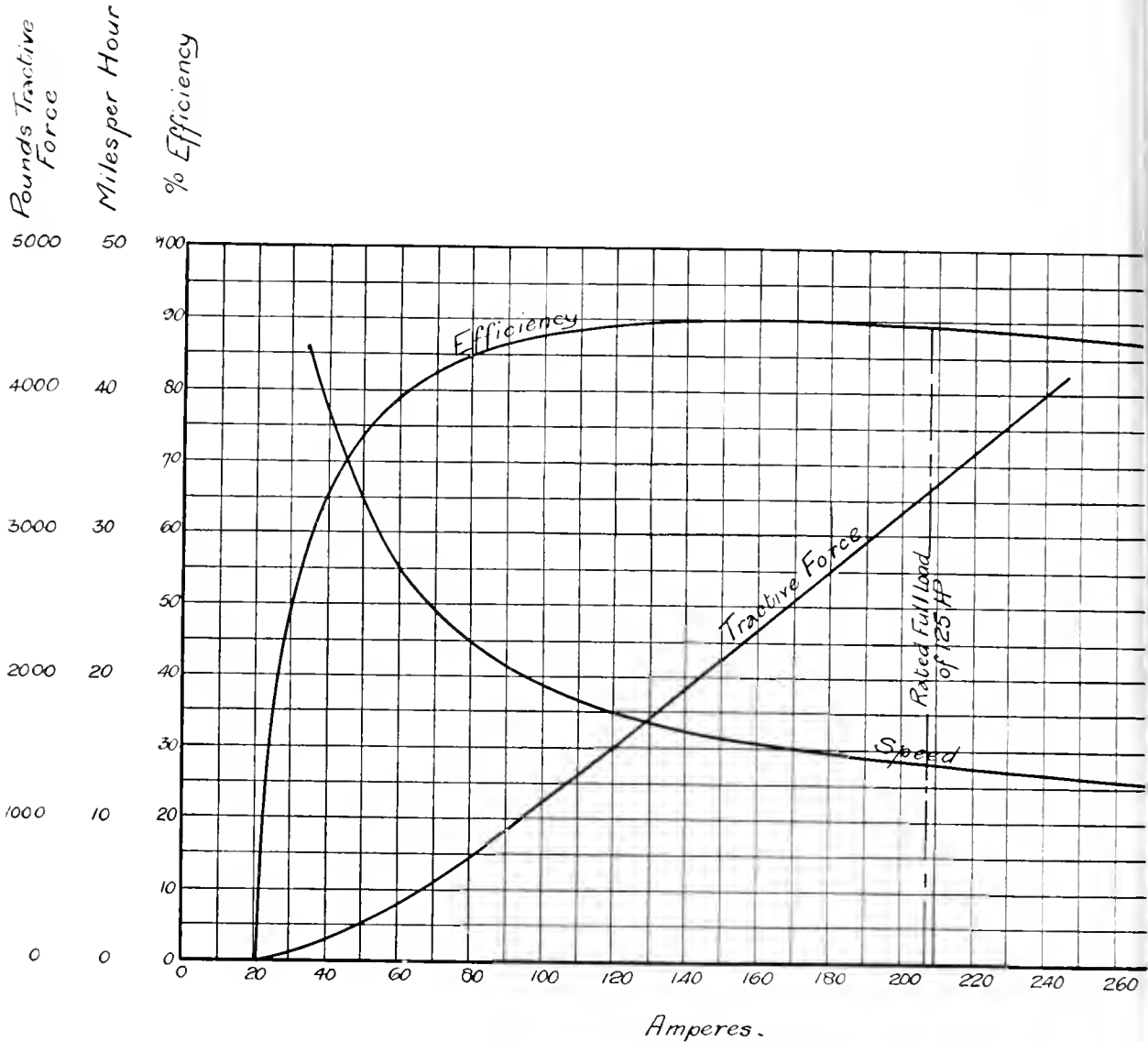

Fig. 50. CURVES SHOWING EFFICIENCY, SPEED, AND TRACTIVE FORCE OF G.E. 66 A. MOTOR OF 125 H.P. RATED OUTPUT.

for continuous-current motors, and in transformers and potential regulators for alternating current motors.

The G.E. 66 A. is rated at 125 h.p. From Fig. 50 we see that its efficiency in the neighbourhood of this load is about 90 per cent. The curves relate to its performance with 500 volts at its terminals. Hence the amperes input at rated load—

$$= \frac{125 \times 746}{0.90 \times 500} = 208 \text{ amperes.}$$

CHARACTERISTICS OF ELECTRIC RAILWAY MOTORS

The ordinate indicated by the broken line in Fig. 50 thus corresponds to the rated load. We find from the speed curve that, with the given gear ratio and wheel diameter, the corresponding speed is 14 miles per hour.

14 m.p.h. = $14 \times 5,280 = 74,000$ ft. per hour = $74,000/60 = 1,230$ ft. per minute.

Car wheel diameter = 34 ins.

Car wheel circumference = $34 \times \pi = 107$ ins. = 8.92 ft.

\therefore Speed of car wheels at rated load of motors (*i.e.* 208 amperes per motor) = $1,230/8.92 = 138$ r.p.m.

\therefore Speed of motors at rated load of 208 amperes per motor = $138 \times 3.94 = 544$ r.p.m.

By means of the slide rule one readily derives the values set forth in Table XIV.

TABLE XIV.

G.E. 66 A. Railway Motor at 500 Volts. Ratio of gearing = 3.94. Diameter of car wheels = 34 ins.

Amperes input	260	208	160	120	80	40	30	21
Watts input	130,000	104,000	80,000	60,000	40,000	20,000	15,000	10,500
Per cent. efficiency	88	90	90	89	85	70	50	—
Watts output	114,000	93,500	72,000	53,400	34,000	14,000	7,500	—
Horse-power output	153	125	96.5	71.5	45.5	18.8	10.1	—
Per cent. of rated load	122	100	77.2	57.3	36.4	15.0	8.3	—
Speed train in miles per hour	12.8	14.0	15.5	17.5	22.5	39.0	—	—
Speed motors in revolutions per minute	497	544	601	680	874	1,510	—	—
Speed motors in per cent. of full load speed	91.5%	100%	110.5%	125%	161%	278%	—	—

From the results in Table XIV, the full line curve of Fig. 51 has been drawn. The two broken lines in Fig. 51 represent the limits for no saturation and absolute saturation respectively. These have merely been transferred from Fig. 49.

The latest type of train on the Central London Railway comprises two motor cars and five trailer cars, the motor cars being at the opposite ends of the train. The motor cars weigh 23 tons each, and the trailers weigh 13.5 tons each. The total seating capacity of the train is for 324 passengers, or 2.85 passengers per ton of unloaded train. Taking an average load factor of 25 per cent. during the period of service of the train, we have an average of 81 passengers per train, or a live load of $(81 \times 140)/2200 = 5.15$ metric tons, thus giving for the weight of train with average load—

$$\begin{aligned}
 \text{Motor cars} &= 2 \times 23 &= 46.0 \text{ tons,} \\
 \text{Trailers} &= 5 \times 13.5 &= 67.5 \text{ tons,} \\
 \text{Passengers} &= \frac{81 \times 140}{2200} &= 5.2 \text{ tons,} \\
 && \underline{\hspace{1.5cm}} \\
 && 118.7 \text{ tons,}
 \end{aligned}$$

or, say, 120 tons for the total train weight.

The motor equipment is made up of two G.E. 66 A. motors on each of the two motor cars, or a total of four G.E. 66 A. motors per train of 120 tons. As the curves of Fig. 50 relate to one G.E. 66 A. motor, it will be convenient to derive from them other data for the total tractive force and total input to the motors. For the present

ELECTRIC RAILWAY ENGINEERING

the losses in the controlling rheostats will be neglected. In actual practice the motors are, at the moment of starting, connected two in series and two in parallel; and, after the acceleration is about half completed, all four motors are thrown in

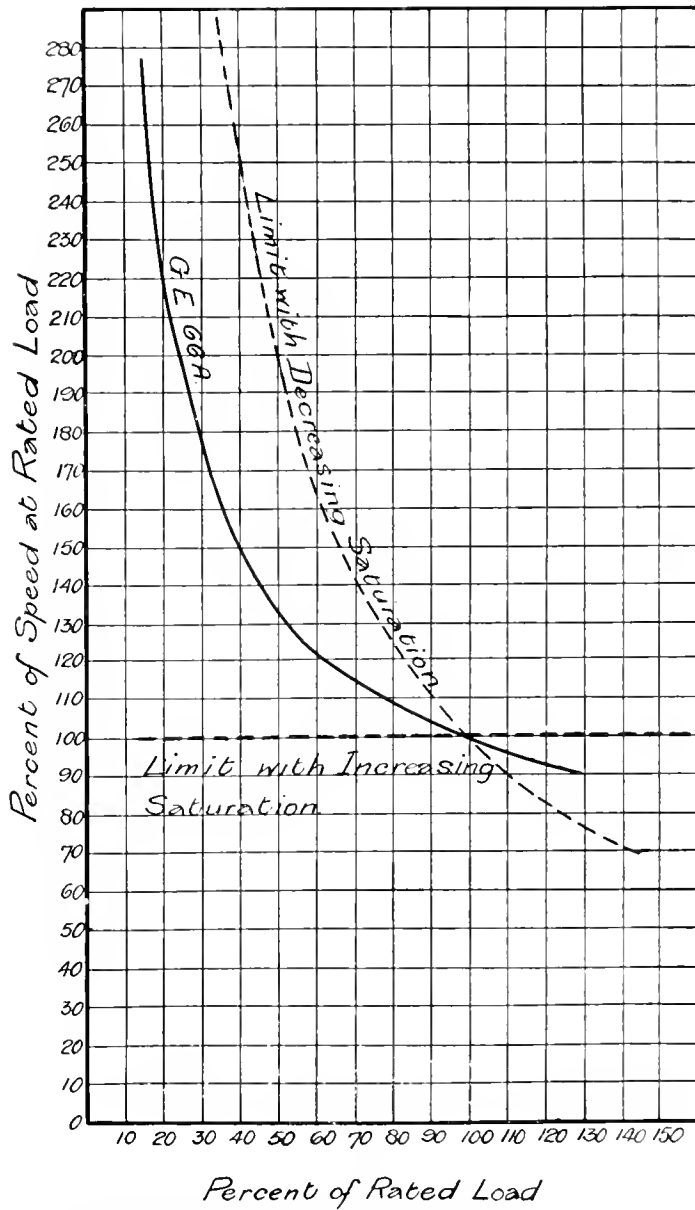

Fig. 51. TO EXPLAIN CONNECTION BETWEEN SPEED AND INPUT OF G.E. 66 A. MOTOR.

parallel. This method of operation by "series-parallel control" reduces the rheostat loss. But for the purpose of explaining the points under immediate consideration, we shall first assume that all four motors are in parallel from the moment of starting. The four motors develop $4 \times 125 = 500$ h.-p. at $4 \times 208 = 832$ amperes input when

CHARACTERISTICS OF ELECTRIC RAILWAY MOTORS

the terminal pressure is 500 volts. With 34-in. wheels and a gear ratio of 3.94, this corresponds to a speed of 14.0 miles per hour, or

$$(14.0 \times 5280) / 60 = 1,230 \text{ ft. per minute.}$$

The output in foot-pounds per minute = $500 \times 33,000 = 16,500,000$.

Hence the tractive force at full load is

$$16,500,000 / 1230 = 13,400 \text{ lbs.,}$$

or $13,400 / 832 = 16.1$ lbs. per ampere at 500 amperes.

For a motor with constant efficiency at all loads and with constant speed (as represented by curve B of Fig. 49), the tractive force per ampere would be a constant for all values of the current; for a motor with constant efficiency at all loads, but with the speed curve A of Fig. 49, *i.e.*, for a motor with no saturation of the magnetic circuit, the tractive force per ampere would be proportional to the current; for the practical case of the G.E. 66 A. motor, the tractive force would vary at an intermediate rate. The tractive force per ampere for this last case is worked out in Table XV., the curves of Fig. 50 serving as the basis for the calculations.

TABLE XV.

Four G.E. 66 A. Railway Motors. Ratio of gearing = 3.94. Diameter of car wheels = 34 ins. All four motors in parallel.

Amperes input per motor	250	208	160	120	80	40	30	21
Amperes input for four motors	1,040	832	640	480	320	160	120	84
Speed train in miles per hour	12.8	14.0	15.5	17.5	22.5	39.0	—	—
Speed train in feet per minute	1,126	1,230	1,363	1,540	1,980	3,430	—	—
Kilowatt input at 500 volts	520	416	320	240	160	80	60	42
Efficiency at 500 volts	88	90	90	89	85	70	50	—
Kilowatt output at 500 volts	457	374	288	214	136	56	30	—
Horse-power output at 500 volts	613	500	386	287	182	75.0	40.2	—
Output in foot-pounds per minute	20,200,000	16,600,000	12,700,000	9,460,000	6,000,000	2,480,000	1,330,000	—
Tractive force in pounds	17,900	13,500	9,300	6,150	3,030	725	—	—
Tractive force in pounds per ampere ¹	17.2	16.1	14.5	12.8	9.46	4.53	—	—

¹ These values are approximately proportional to the flux.

The results are plotted in the full line curve of Fig. 52, together with the limiting curves for equivalent motors with increasing and decreasing saturation of the magnetic circuit.

Assuming constant internal losses in a series motor, the tractive force exerted will be precisely the same for a given current through the motor, whether the motor be at rest or running at any speed. Now we shall introduce but slight inaccuracy by neglecting the difference in the internal losses, and we are thus enabled to deduce the initial accelerating rate which we may obtain with any current. This is done in Table XVI.

ELECTRIC RAILWAY ENGINEERING

TABLE XVI.

Four G.E. 66 A. Railway Motors. Ratio of gearing = 3.94. Diameter of car wheels = 34 ins. All four motors in parallel.

Amperes input per train	1,040	832	640	480	320	160	120	84
Tractive force in pounds	17,900	13,500	9,300	6,150	3,030	725	—	0
" " " per ton weight of train	149	112.5	77.5	51.2	25.2	6.1	—	0
Initial rate of acceleration in miles per hour per second, neglecting the train resistance at very low speeds	1.49	1.13	0.775	0.512	0.252	0.061	—	0

Curve I. in Fig. 53 is plotted with ordinates equal to the tractive force per ton weight of train, and with abscisse equal to the amperes input with all four motors in

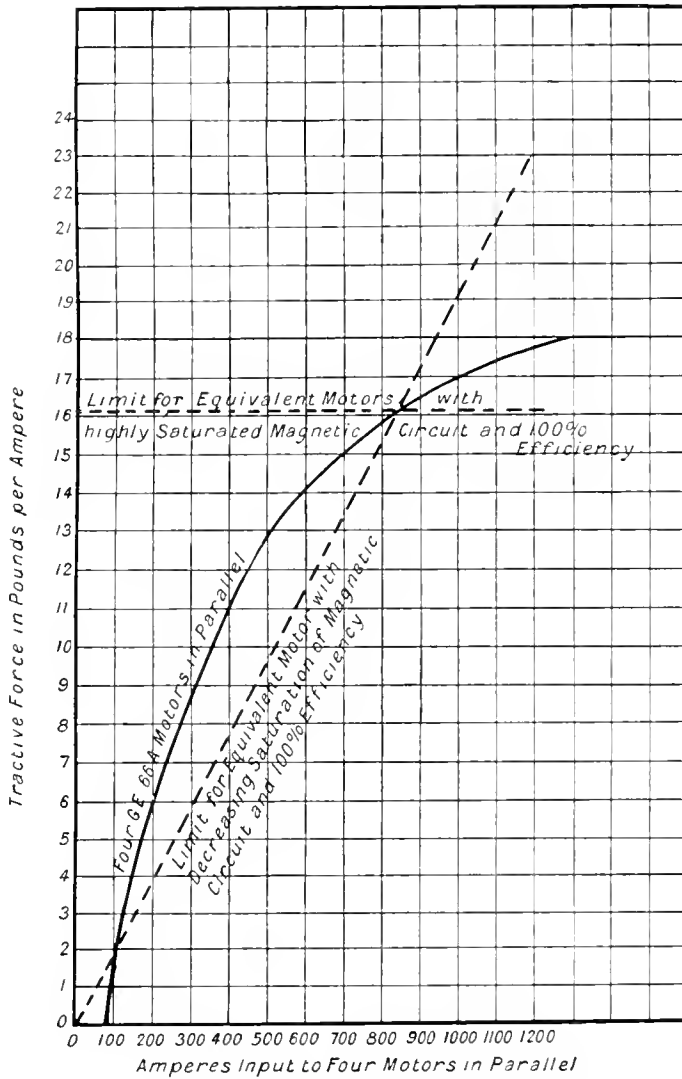

Fig. 52. TO EXPLAIN CONNECTION BETWEEN TRACTIVE FORCE AND INPUT, USING FOUR G.E. 66 A. MOTORS.

CHARACTERISTICS OF ELECTRIC RAILWAY MOTORS

parallel. This same curve, owing to a purely accidental coincidence resulting from the particular system of units we have employed in these articles, might also be read, as indicated in the figure, to ordinates expressing the initial acceleration in miles per hour per second, provided that the train resistance could, at very low speeds, be neglected. From Fig. 6 (on p. 9) we find, however, that the train resistance at low speeds amounts to some 6 lbs. per ton. Hence curve II. has been added on Fig. 53, with ordinates reduced by 6 lbs. below the corresponding points of curve I.

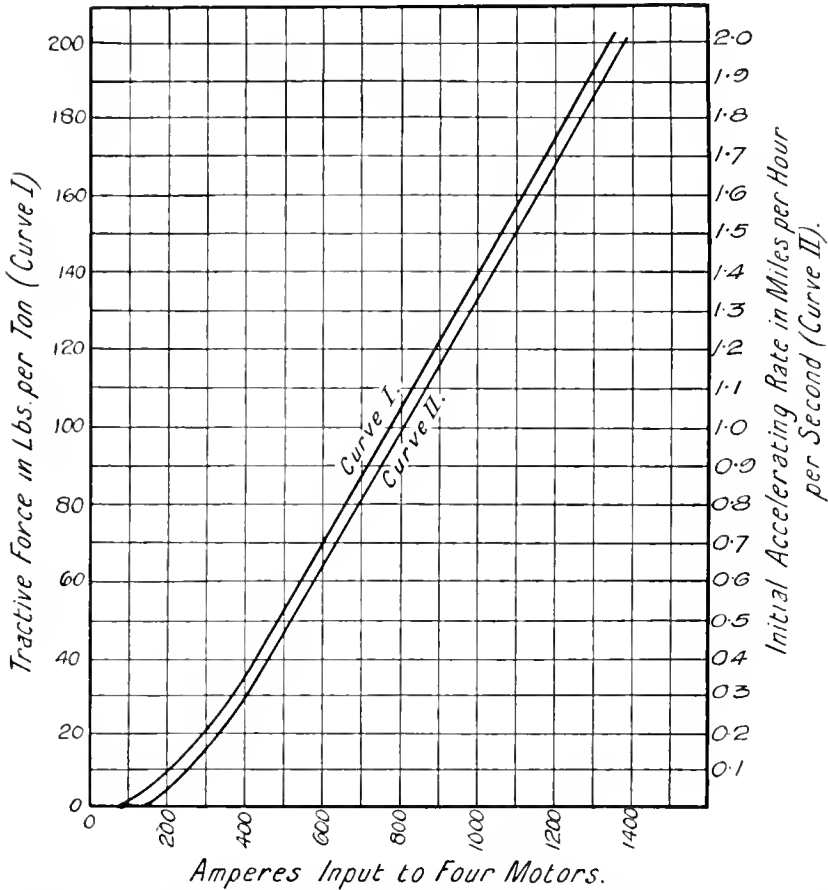

Fig. 53. TO EXPLAIN CONNECTION BETWEEN TRACTIVE FORCE (CURVE I.), INITIAL ACCELERATING RATE (CURVE II.) AND INPUT, USING FOUR G.E. 66 A. MOTORS.

Now, suppose we wish to operate one of these Central London trains with a constant rate of acceleration of 1 mile per hour per second. When the train is at rest, we shall require such a resistance in the circuit as to permit the 500 terminal volts to send in 800 amperes. Obviously we shall require $500/800 = 0.625$ ohm in the circuit. Two factors would enter to reduce the amount of resistance required at the first instant. The first factor is the inductance of the motors (chiefly in the field windings), and of the apparatus and lines through which these derive their supply. The second factor is the great resistance of the train when at rest, which makes it necessary, for the first instant, to have a much heavier current to obtain the desired

ELECTRIC RAILWAY ENGINEERING

initial acceleration of 1 mile per hour per second. We can, however, neglect these two figures for the present investigation; we shall, therefore, assume that the train starts as calculated, with an acceleration of 1 mile per hour per second. But immediately the motors begin to gain speed, they generate a counter-electromotive force which will reduce the voltage across the external resistance, and hence also the current and the accelerating rate, until a section of the rheostat is cut out. The accelerating rate may thus be restored and maintained at the original value, by successively cutting out sections of the starting rheostats. Suppose that when the last section of external resistance is cut out, the motors are running at a speed corresponding to but 470 volts counter-electromotive force. At first a current will flow equal to $\frac{1}{2}(500-470)/\text{internal resistance of motors}$; but this will gradually be reduced by the increasing counter-electromotive force of the motors, and the current will gradually fall, approaching as a limit the value required to overcome the tractive resistance of the train at the corresponding speed.

The subject of "acceleration on the motor curve" has occasioned a good deal of discussion, and should be considered with some care at this point.

The internal resistance of the G.E. 66 A. motor at 75 degrees Cent. is equal to 0.13 ohm. Resistance of four motors in parallel = $0.13 \div 4 = 0.033$ ohm. Suppose we wish, in the case of the standard Central London train, to have an initial acceleration of 1 mile per hour per second. We have already seen that, neglecting the reactance of the circuits and the higher resistance of the train when at rest, we should require a resistance of $500/800 = 0.625$ ohm; and of this the resistance external to the motors would be $0.625 - 0.033 = 0.59$ ohm. The current flowing from the line at the instant of closing the circuit will be 800 amperes. Let us, as an approximation, consider successive intervals of 1.0 second each. For the first ten of these intervals let us leave the external resistance unchanged. At the end of 1 second the speed of the train will be nearly 1 mile per hour; it will not be quite 1 mile per hour, for, as we are about to ascertain, the current, and hence the accelerating rate, will decrease during the course of the 1 second interval. Let us take it, however, at approximately 1 mile per hour. From Fig. 50 we find that with a current of $800/4 = 200$ amperes per motor, the constant speed of the motor is 14 miles per hour when operated with 500 volts across its terminals. Its counter-electromotive force is then $500 - 200 \times 0.13 = 500 - 26 = 474$ volts. Hence, with the same current strength of 200 amperes per motor, the counter-electromotive force at a speed of 1 mile per hour will be $(1/14) \times 474 = 33.8$ volts.

Hence the current input to the four motors in parallel will, at the end of 1 second, be equal to $(500 - 33.8)/0.625 = 745$ amperes.

For this current strength, we find from curve II. of Fig. 53 that the accelerating rate is only 0.90 miles per hour per second. Hence the mean acceleration for the first second will be but $(1.00 + 0.90)/2 = 0.95$ mile per hour per second. Were this maintained during the following second, the speed at the end of 2 seconds would be 1.90 miles per hour, the counter-electromotive force would be $1.9 \times (474/14) = 64$ volts, and the current input to the four motors in parallel would be $(500 - 64)/0.625 = 697$ amperes.

The smaller the component intervals for which we make the calculations, the more correct will be the result. Making precise calculations by the less elementary but more exact method (described in the note on p. 63), for the first 10 seconds during which the external resistance is maintained constant at 0.59 ohm, we obtain values from which the curves of Figs. 54, 55, and 56 have been plotted. It is evident that the mean acceleration for the first 10 seconds is only 0.69 mile per hour per second. At

Acceleration - Time Curves

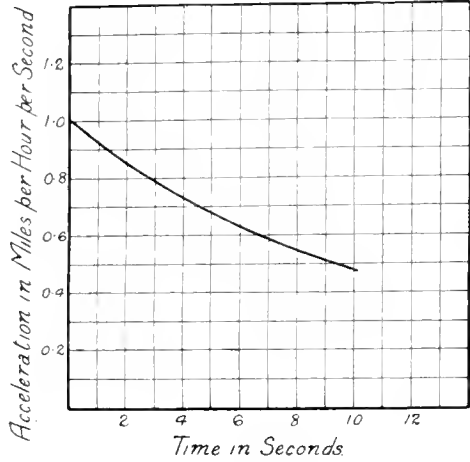

Fig. 54

Current - Time Curves

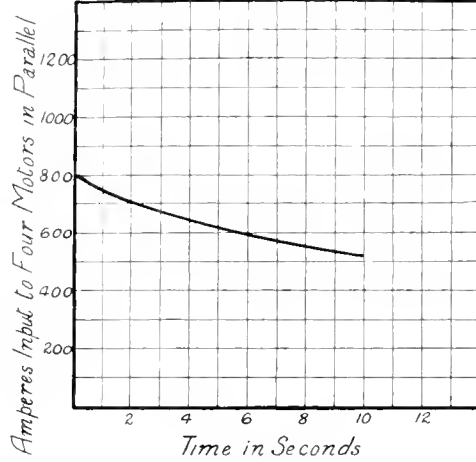

Fig. 55

Speed - Time Curves

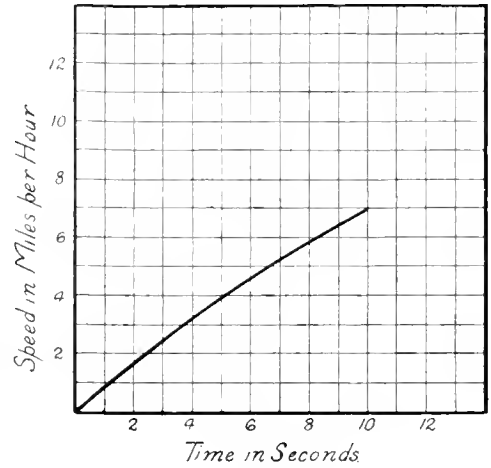

Fig. 56

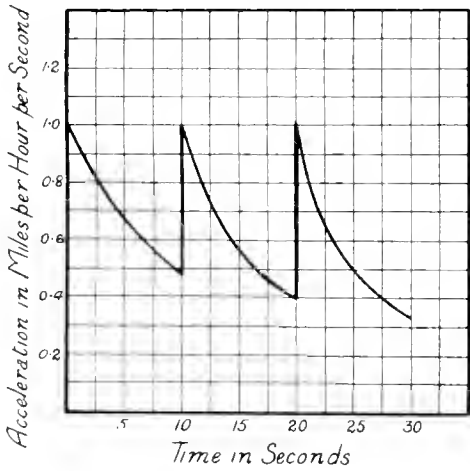

Fig. 57

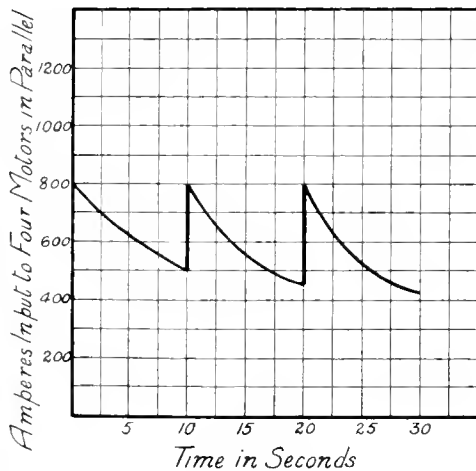

Fig. 58

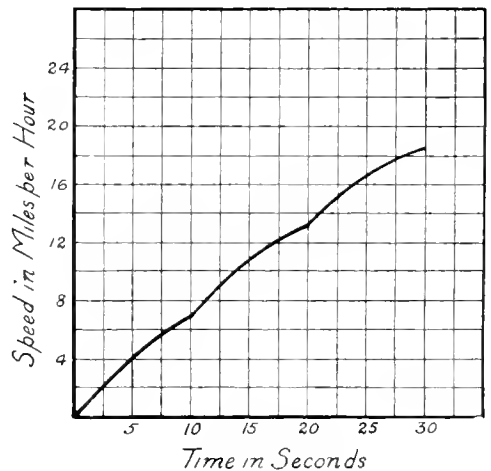

Fig. 59

CHARACTERISTICS OF ELECTRIC RAILWAY MOTORS

the end of 10 seconds, the speed is 6.9 miles per hour. Let us now reduce the resistance in the motor circuit to such a value that the acceleration is restored to its original value of 1 mile per hour per second. This must be such a resistance as shall bring the current again up to its original value of 800 amperes. At a speed of 6.9 miles per hour, this latter current produces a counter-electromotive force of $33.8 \times 6.9 = 234$ volts; the voltage drop in the resistance must therefore be $500 - 234 = 266$ volts, and the resistance $= 266/800 = 0.333$ ohm, corresponding to an external resistance of $0.333 - 0.033 = 0.30$ ohm.

From Figs. 57, 58 and 59, we see that, during the next 10 seconds, the acceleration decreases from 1.0 mile per hour per second to 0.39 mile per hour per second, the current input decreases from 800 amperes to 450 amperes, and the speed increases from 6.9 miles per hour to 13.1 miles per hour; the mean acceleration during the second step (10 to 20 seconds) is therefore 0.62 mile per hour per second. Let us now again cut out the external resistance in order to bring the acceleration up to its original value. We find, by the method which we employed for the second stage, that the resistance in the motor circuit for the third stage

$$= \frac{500 - 33.8 \times 13.1}{800} = \frac{500 - 443}{800} = \frac{57}{800} = 0.071 \text{ ohm};$$

therefore the external resistance $= 0.071 - 0.033 = 0.038$ ohm.

The results of employing this resistance in circuit during the following seconds are shown in the third sections of Figs. 57, 58, and 59. The speed is now 18.5 miles per hour, the average acceleration during the third step being 0.54 mile per hour per second, and the average acceleration during the total 30 seconds from the start $= 0.62$ mile per hour per second.

Knowing, as we now do from the curves of Fig. 57, that the rate of acceleration will fluctuate more widely at each succeeding 10-second interval, we draw the conclusion, borne out in practice, that the interval of running on each successive step should be decreased. Thus, if we worked between the limits of 800 amperes and 500 amperes, the first three intervals would be (roughly) 10, 7, and 6 seconds; this would obviously affect the subdivision required in the rheostats. The matter is very complicated, and is rendered still more so by the customary practice of operating with "series parallel" control, to which we shall shortly give our attention.

The main point to which we here wish to draw attention is, that the whole accelerating interval is made up of sections, during each of which we are "running on the motor characteristic," except in so far as the motor characteristic is modified by a resistance of constant value in series with the internal resistance of the motor.

Note on the Exact Method used in obtaining Figs. 54 to 59.

The exact method, essentially a graphical one, consists in deriving a relation between speed and acceleration. For that purpose, in Fig. 60 the current inputs have been taken as abscissæ. As ordinates have been plotted—

- (1) The tractive force in pounds per ton (taken from Fig. 53);
- (2) The speed in miles per hour, corresponding to the current input and to the resistance in the motor circuit.

In Fig. 60, 0.625 ohm has been taken as total resistance. The internal voltage would be $(500 - 0.625 I)$, while for the speed curve given in Fig. 50 the internal voltage for the same current would be $(500 - 0.033 I)$.

ELECTRIC RAILWAY ENGINEERING

To obtain the speed curve in Fig. 60, it has merely been necessary to calculate the ratio

$$500 - 0.625 I.$$

$$500 - 0.033 I.$$

for various currents, and to multiply the speed given in Fig. 50 by this ratio.

From Fig. 60, curve I. of Fig. 61 may be plotted, with speeds as abscissæ and tractive forces as ordinates. The train resistance is plotted as a function of the speed in curve II. of Fig. 61; and the difference between curve I. and curve II. equals that part of the tractive force directly available for acceleration. As a tractive force of

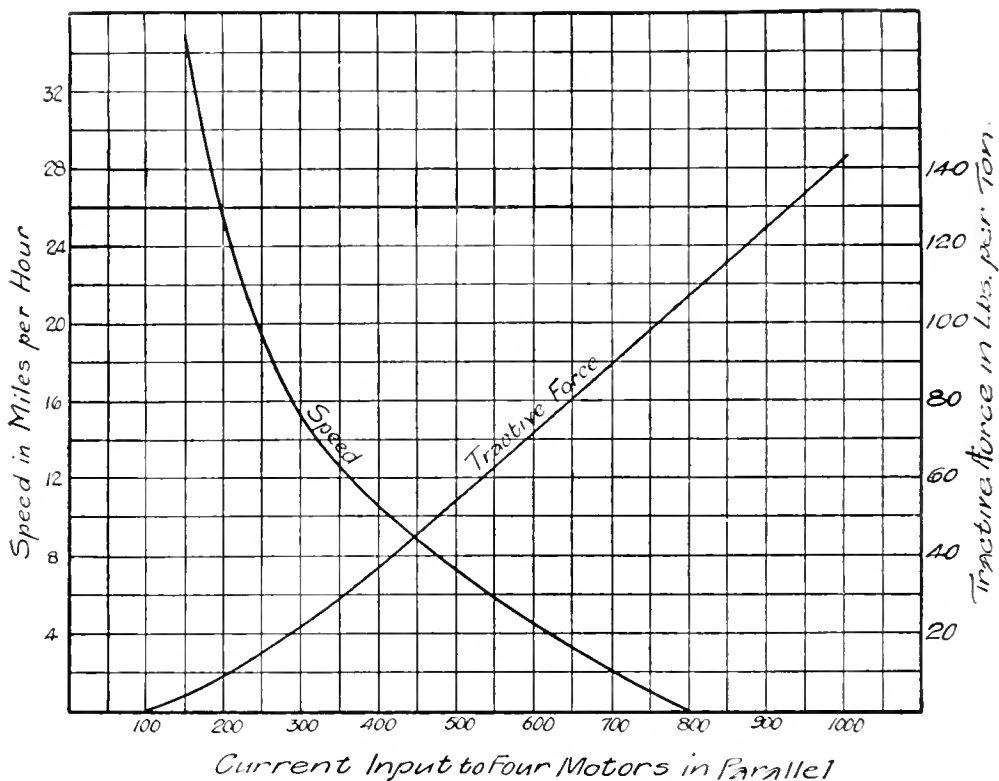

Fig. 60. CHARACTERISTIC CURVES OF PARALLEL OPERATION OF FOUR G.E. 66 A. MOTORS.

100 lbs. per ton produces an acceleration of 1 mile per hour per second, the required relation between speed and acceleration has thus been found. For clearness, this has been plotted again in Fig. 62. In Fig. 63, a curve has been plotted with time in seconds as abscissæ, and speed in miles per hour as ordinates. This latter curve is derived from the curve in Fig. 62, since we know that the tangent to the speed-time curve in Fig. 63 is proportional to the corresponding value of the acceleration in the curve in Fig. 62.

The method, as described above, can be used for any resistance, and in case it is desired to calculate a total set of resistances, a great many interesting relations may be found between the different curves representing the various resistances.

Without going into the details of the calculation, which would be on the lines already set forth in the previous example, we give in Figs. 64, 65, and 66 a set of

CHARACTERISTICS OF ELECTRIC RAILWAY MOTORS

curves (corresponding to those of Figs. 57, 58, and 59) for a *mean* acceleration of 1 mile per hour per second, in which, instead of maintaining constant *time* intervals per step, we work between a maximum of 930 amperes and a minimum of 690 amperes

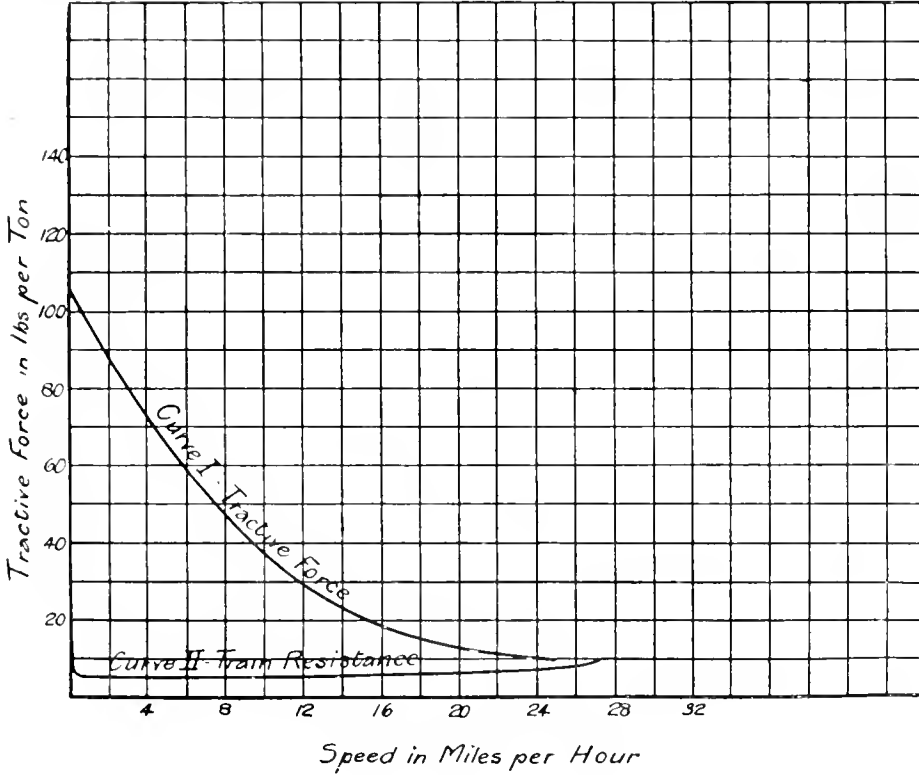

Fig. 61. CHARACTERISTIC CURVES OF PARALLEL OPERATION OF FOUR G.E. 66 A MOTORS.

input to the four motors in parallel on each step. This accelerating rate is maintained until a speed of 13.4 miles per hour is attained. The resistance per controller point and the number of seconds duration of run on each point are set forth in Table XVII.

TABLE XVII.

Controller Positions for Four G.E. 66 A Motors. Mean acceleration = 1 mile per hour per second. Speed = 13.4 miles per hour.

Controller Point.	Time in Seconds on each Point.	Resistance in Series with Motors on each Point, in Ohms.
1	3.9	0.50
2	3.2	0.36
3	2.6	0.24
4	2.1	0.14
5	1.6	0.064

13.4 seconds have now elapsed since the current was thrown on. Let the movement to the sixth controller point consist in cutting out the remaining external resistance of 0.064 ohm, and let the motors continue to accelerate with only the

ELECTRIC RAILWAY ENGINEERING

internal resistance of the four motors in parallel, *i.e.*, 0.033 ohm, in circuit. We are thus "accelerating on the motor characteristic," as it is generally described. Let us continue running on the motor characteristic for 85.6 seconds. The acceleration will gradually decrease, and at the end of 85.6 seconds, which is 99 seconds from the time of starting, the acceleration will have decreased to only 0.06 mile per hour per second (see Fig. 67). At this point a speed of 28.4 miles per hour will have been attained (see Fig. 69). Let the current now be cut off, and the train permitted to coast (or drift) for 41 seconds. The retardation during coasting will be due solely to the train friction. From Fig. 6 (on p. 9 of Chapter I.) we see that, at speeds of some 27 miles per hour the train friction of a 120-ton train has on the Central London Railway been determined

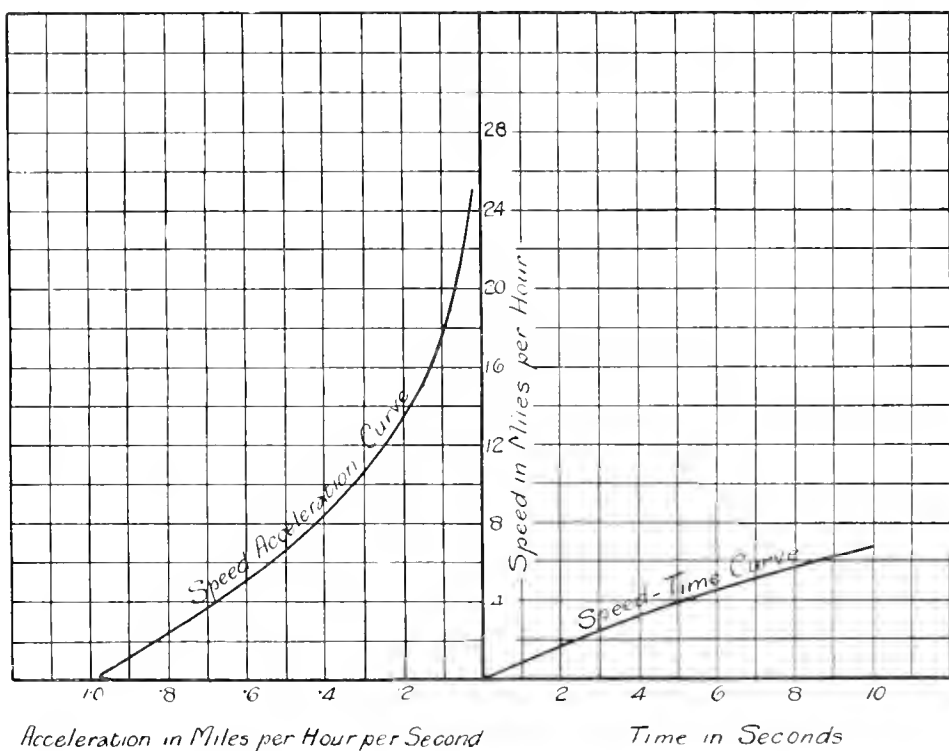

Fig. 62.

Fig. 63.

Figs. 62 and 63. CHARACTERISTIC CURVES OF PARALLEL OPERATION OF FOUR G.E. 66 A MOTORS.

as about 9 lbs. per ton. On p. 21 of Chapter II. the rule was given that on a level track a tractive force of 100 lbs. per ton, in addition to the force required to overcome the tractive resistance, imparts to a train an acceleration of 1 mile per hour per second. Hence it follows that a train friction of 9 lbs. per ton will produce a retardation of 0.09 mile per hour per second. Therefore, at the end of 41 seconds of coasting, the speed will have fallen by $41 \times 0.09 = 3.7$ miles per hour below the maximum speed of 28.4 miles per hour, or to 24.7 miles per hour. At the end of 41 seconds of "drifting," 140 seconds will have elapsed since starting. Let the brakes now be applied, and with a pressure sufficient to increase the total train friction to 100 lbs. per ton. This will increase the rate of retardation to 1 mile per hour per second, and will bring the train to rest in 24.7 (say 25) seconds, or 165 seconds from the start. Now during the acceleration on the first five controller points, *i.e.*, during

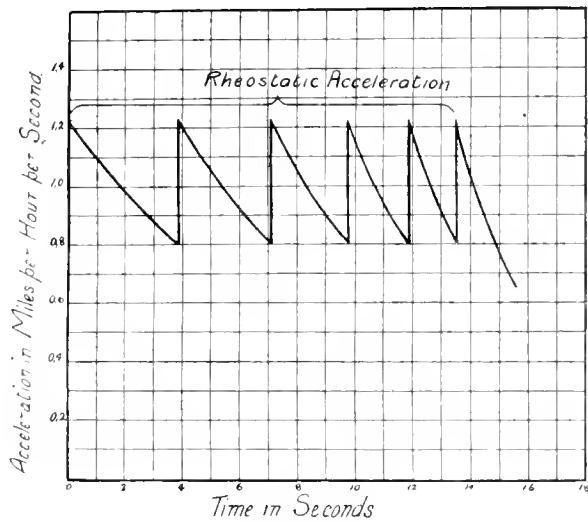

Fig. 61.

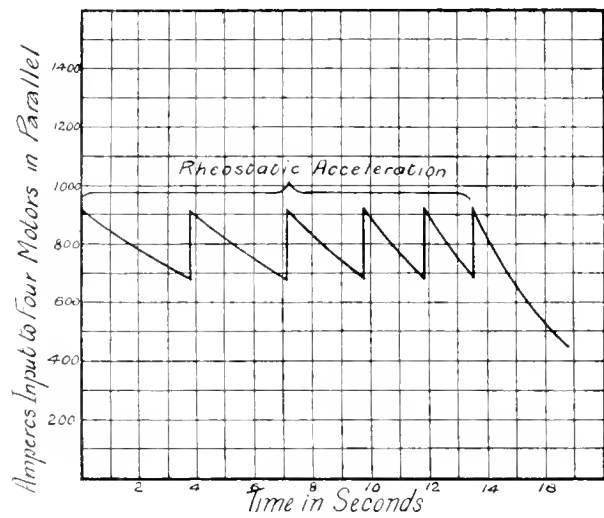

Fig. 65.

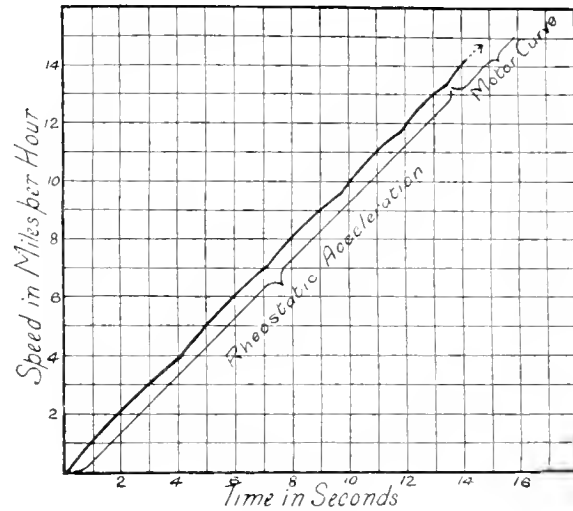
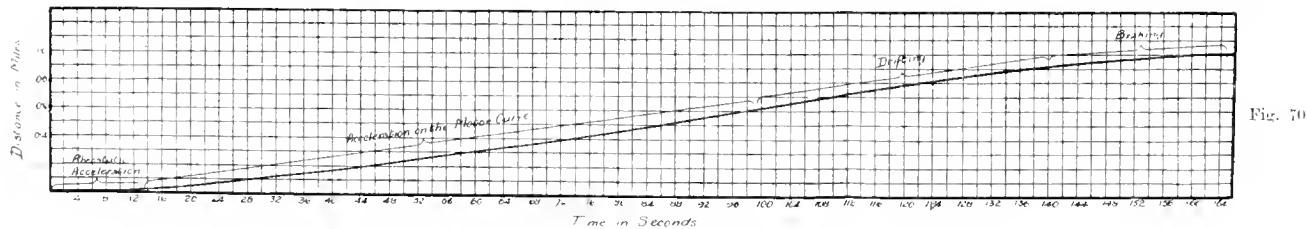
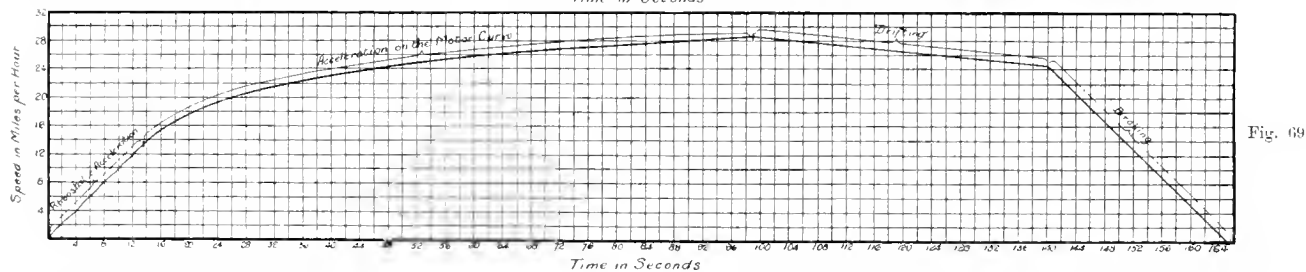
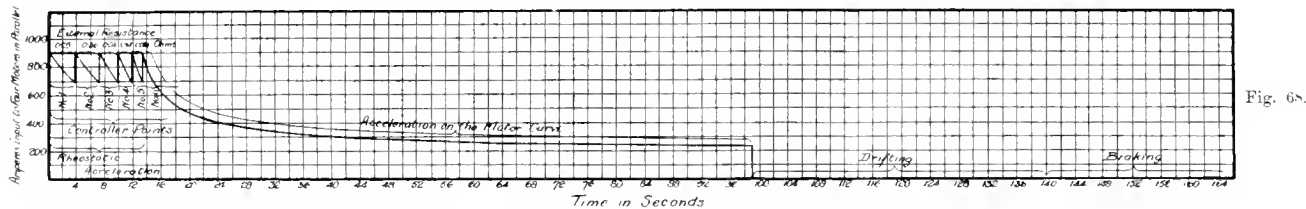
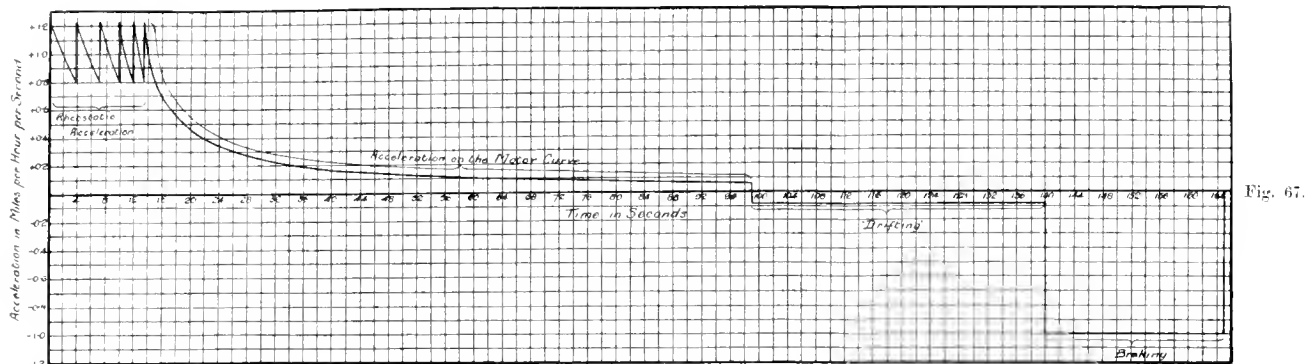

Fig. 66.



FIGS. 67-70. ACCELERATION-CURRENT-SPEED-DISTANCE-TIME CURVES FOR FOUR G. E. 66 A MOTORS IN PARALLEL.

CHARACTERISTICS OF ELECTRIC RAILWAY MOTORS

the first 13.4 seconds, we maintained a mean acceleration of 1 mile per hour per second. Hence, for this interval, the mean speed was 6.7 miles per hour, and the distance covered was $6.7 \times \frac{13.4}{3,600} = 0.025$ mile. During the 85.6 seconds of operation on the sixth controller point the speed increased at an ever slower rate, as is seen from the curve of Fig. 69, and the mean speed is readily seen from this curve to be 24.4 miles per hour. Hence the distance covered on the sixth controller point

$$= 24.4 \times \frac{85.6}{3,600} = 0.584 \text{ mile.}$$

During "drifting" the mean speed is equal to

$$\frac{28.4 + 24.7}{2} = 26.6 \text{ miles per hour,}$$

and the distance covered equals

$$26.6 \times \frac{41}{3,600} = 0.302 \text{ mile.}$$

During braking the mean speed is

$$\frac{24.7}{2} = 12.4 \text{ miles per hour,}$$

and the distance covered is

$$12.4 \times \frac{25}{3,600} = 0.086 \text{ mile.}$$

We have thus obtained the values set forth in Table XVIII.

TABLE XVIII.

Distance Covered during each Operation for run of One Mile.

Operation.	Time in Seconds.	Mean Rate of Acceleration in Miles per Hour per Second.	Mean Speed in Miles per Hour.	Distance covered in Miles.
Rheostatic acceleration	13.4	+1.00	6.7	0.025
Acceleration on the motor curve	85.6	+0.18	24.5	0.584
Drifting	41.0	-0.09	26.6	0.302
Braking	25.0	-1.00	12.5	0.086

Adding up the four items in the last column, we find that we have covered a distance of 1 mile (0.997 mile). Hence the average speed is equal to $\frac{3,600}{165} = 21.8$ miles per hour. The acceleration, the current, the speed, and the distance at each moment from start to stop are plotted in Figs. 67, 68, 69, and 70.

From the values of the current in Fig. 68 and the constant terminal potential of 500 volts we obtain the kilowatts gross input to the train at any instant. From the values of the resistance external to the motors at each step, which are given in Table XVII., and the corresponding values of the current which are obtained from Fig. 68, the kilowatts dissipated in the rheostats at any moment may be calculated. The kilowatts gross input to the train, the kilowatts dissipated in rheostats, and the kilowatts input to the four motors are plotted in the three curves of Fig. 71. The curve of input to the motors is repeated in Fig. 72, and there is also drawn the corresponding curve of output from the motors, *i.e.*, of the energy finally delivered to the car wheels. This latter curve could also have been derived from the speed and

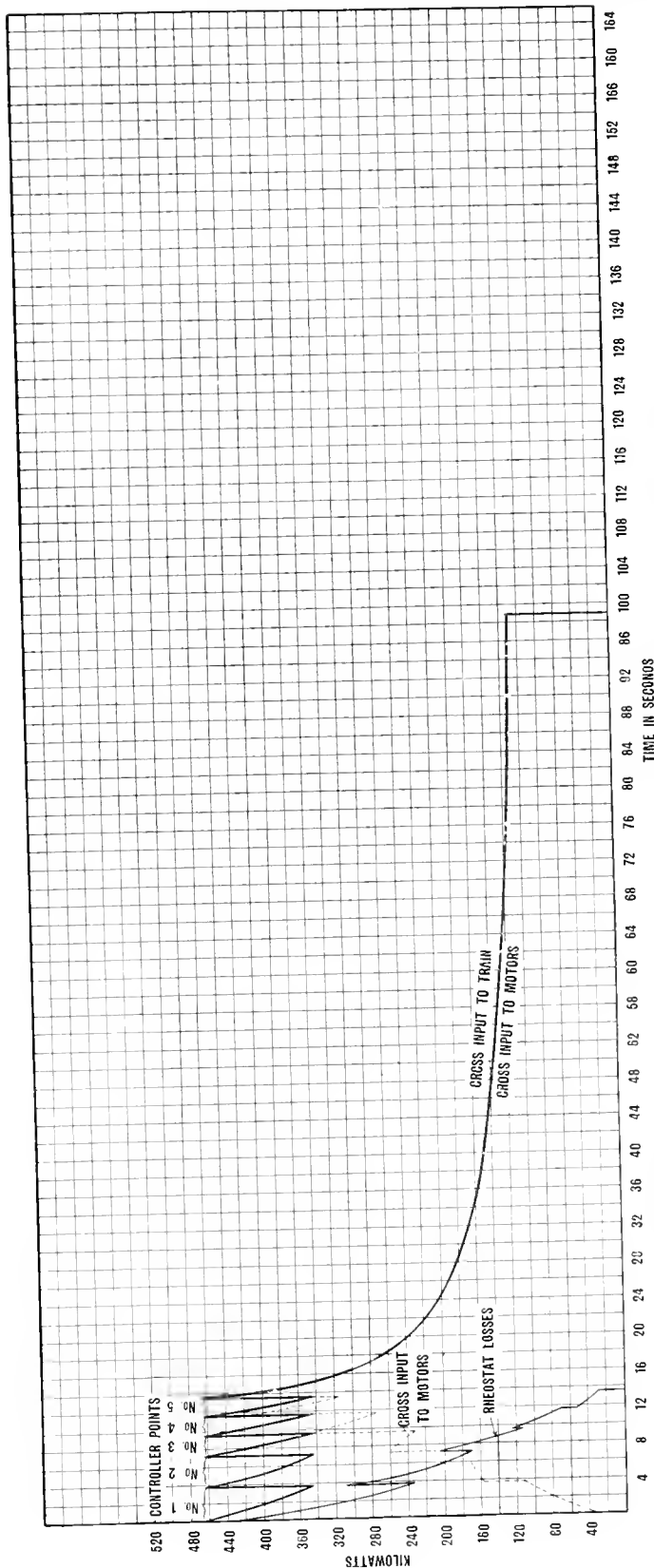

Fig. 71. CURVES ALLOCATING THE DISTRIBUTION OF THE ENERGY WITH FOUR G6 A MOTORS IN PARALLEL.

tractive force from instant to instant, and it has, as a matter of fact, been checked by this means. From the curve of gross energy consumption in Fig. 71 we find that the train has consumed 18,340 kilowatt-seconds, or 5.10 kilowatt-hours, in the 1-mile run from start to stop, or 42.2 watt-hours per ton-mile. From the curve of energy finally delivered to the axles in Fig. 72 we find that there has been required at the axles for the 1-mile run 13,330 kilowatt-seconds, or 3.7 kilowatt-hours, or 30.7 watt-hours per ton-mile. The efficiency from contact shoe to car wheels is therefore 72.6 per cent. for this 1-mile run from start to stop.

Now let us carry the calculations through for this same 120-ton train operating with one stop per mile at a schedule speed of 21.8 miles per hour, and with the assumption of constant acceleration and retardation at the rate of 1 mile per hour per second, and with uniform speed operation from completion of acceleration to commencement of retardation. In Figs. 73, 74, and 75 are given the speed, tractive force, and nett energy for this cycle of operations with straight line acceleration and retardation. The nett energy required at the car wheels

CHARACTERISTICS OF ELECTRIC RAILWAY MOTORS

will be found, by integrating Fig. 75, to be 14,700 kilowatt-seconds, or 4.1 kilowatt-hours. These values are but slightly (11 per cent.) greater than those obtained with operation on the motor curve characteristic, confirming thereby, at least for this case, the admissibility of the assumption made in the earlier articles of this series.

Table XIX. gives the watt-hours per ton-mile at the car wheels, and also the maximum energy at the car wheels in watts.

TABLE XIX.

Nett Energy at Car Wheel. Mean rate of acceleration = 1 mile per hour per second.

Fig. Numbers.	Method of Operation.	Watt-hours per Ton-mile at Car Wheel.	Maximum Energy at Car Wheel in Watts.	Average Energy at Car Wheels from Start to Stop, in Ohms.	Ratio of Maximum to Average Energy at Car Wheels.
67 to 72	Acceleration on the motor curve	30.7	440,000	81,000	5.45
73 to 75	Straight-line acceleration	34.0	680,000	89,000	7.65

It is clear that the result for the maximum energy required, is considerably too high when derived from our diagrams with "straight-line acceleration," and this fact must often be taken into consideration in cases where the diagram is used, although, as we see, the error involved by not taking it into consideration, leaves us on the safe side. The "diversity factor" in train operation, obscures the significance of absolute values for the "ratio of maximum to average energy at car wheels." The important point is to realise that this ratio is so large a figure as 6 or thereabouts, in such a case, and that it would be considerably larger were it not for the decrease effected by accelerating on the motor curve.

In the example of motor control which we have worked out above in considerable detail, we have assumed a case where the four motors are in parallel during the entire accelerating interval. It is, however, almost universal practice, where four continuous-current railway motors constitute a single equipment operated from a 500-volt circuit, to connect them, two in series and two in parallel, during the early portion of the accelerating period. After the resistance in series with this series-parallel combination of the motors, has been gradually cut out, the four motors are all connected in parallel with one another, but at first in series with external resistance, which is again gradually cut out. To start the train with the same acceleration as for the parallel connections used in the curves of Figs. 67 to 72, the total resistance on the motor circuit would have to be double its former value; therefore

$$2 \times (\text{external resistance of } 0.50 \text{ ohms} + \text{motor resistance of } 0.033 \text{ ohms}) = 1.066 \text{ ohms.}$$

The internal resistance of the four motors in series-parallel (or briefly in "series") connection is four times its former value, *i.e.*—

$$4 \times 0.033 = 0.13 \text{ ohms.}$$

The required external resistance is therefore—

$$1.066 - 0.13 = 0.934 \text{ ohms.}$$

With increasing speed, the decrease in the tractive force and in the rate of acceleration, was derived in the previous case. The rate of decrease with increasing speed is now, however, considerably greater, as the total counter-E.M.F. (*i.e.*, the counter-E.M.F. of two motors in series) is, for a given current per motor and a given

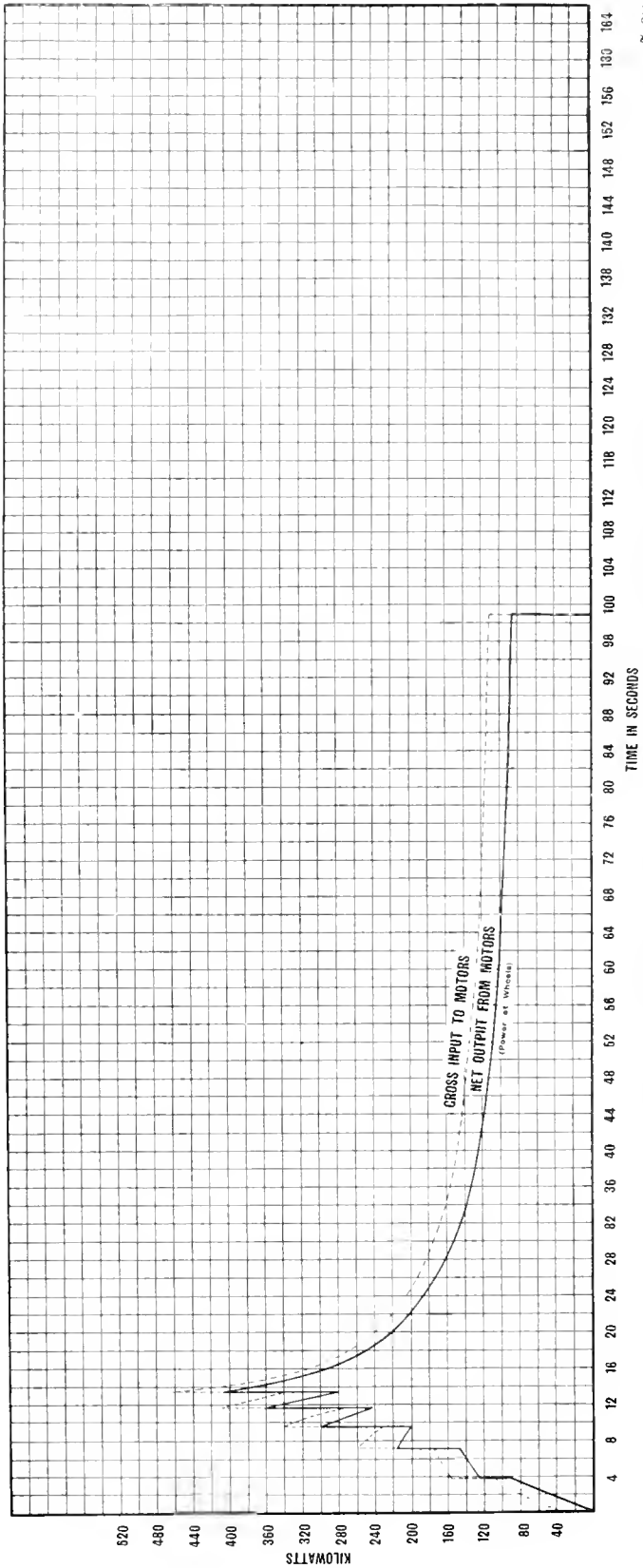

Fig. 72. CURVES OF INPUT AND OUTPUT FOR FOUR G.E. 66-A MOTORS IN PARALLEL.

speed, exactly double its former value. In fact, the rate of decrease with increasing speed is exactly double its former value. Thus if, for the parallel connection, the current reaches a certain minimum value in 2 seconds, it will, if the same accelerating rate is maintained in both cases, reach the same minimum value in 1 second when in "series" connection. We can therefore at once use the curves of Fig. 64 for the "series" connection by simply designating the abscissæ as 0.1, 2, 3, etc., in place of their original values of 0, 2, 4, 6, etc., provided that the total resistance in the motor circuit is, for each step, double its former value. This will require that the external resistance shall be successively 0.935, 0.655, 0.415, 0.215, 0.063, 0, whereas, corresponding to the "parallel" connection, it is 0.50, 0.36, 0.24, 0.14, 0.064, 0, as set forth in Table XVII. (on p. 65).

Under these conditions, Fig. 64 is at once applicable to "series-parallel" control. In a similar way, Figs. 65 and 66 may be used again, if the abscissæ and ordinates are numbered with half their original values. After $6.7 \left(= \frac{13.4}{2} \right)$ seconds, the last section of resistance is cut out,

Fig. 73.

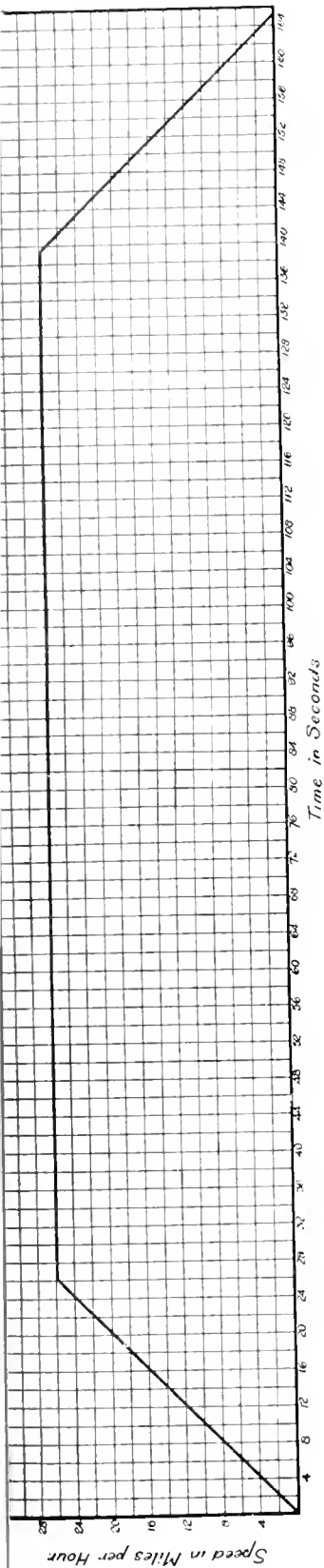

Fig. 74.

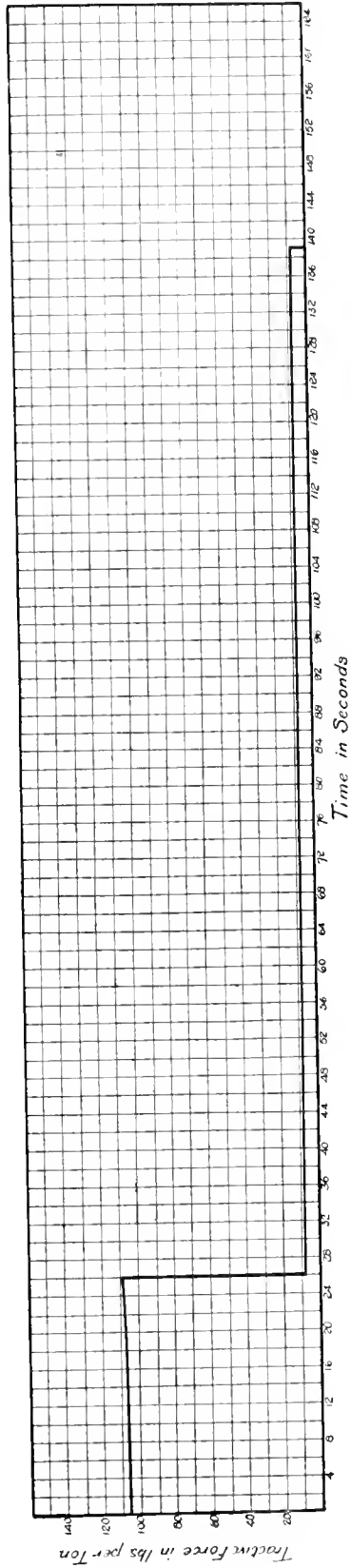
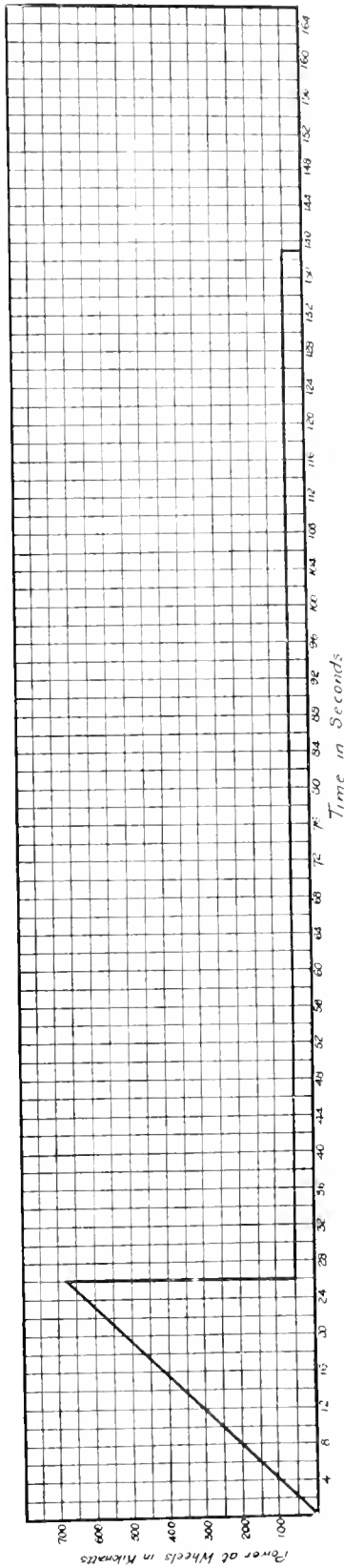

Fig. 75.



Figs. 73 to 75. SPEED, TRACTIVE FORCE AND POWER CURVES FOR FOUR G.E. 66 A MOTORS IN PARALLEL, AND ASSUMING STRAIGHT-LINE ACCELERATION AND RETARDATION.

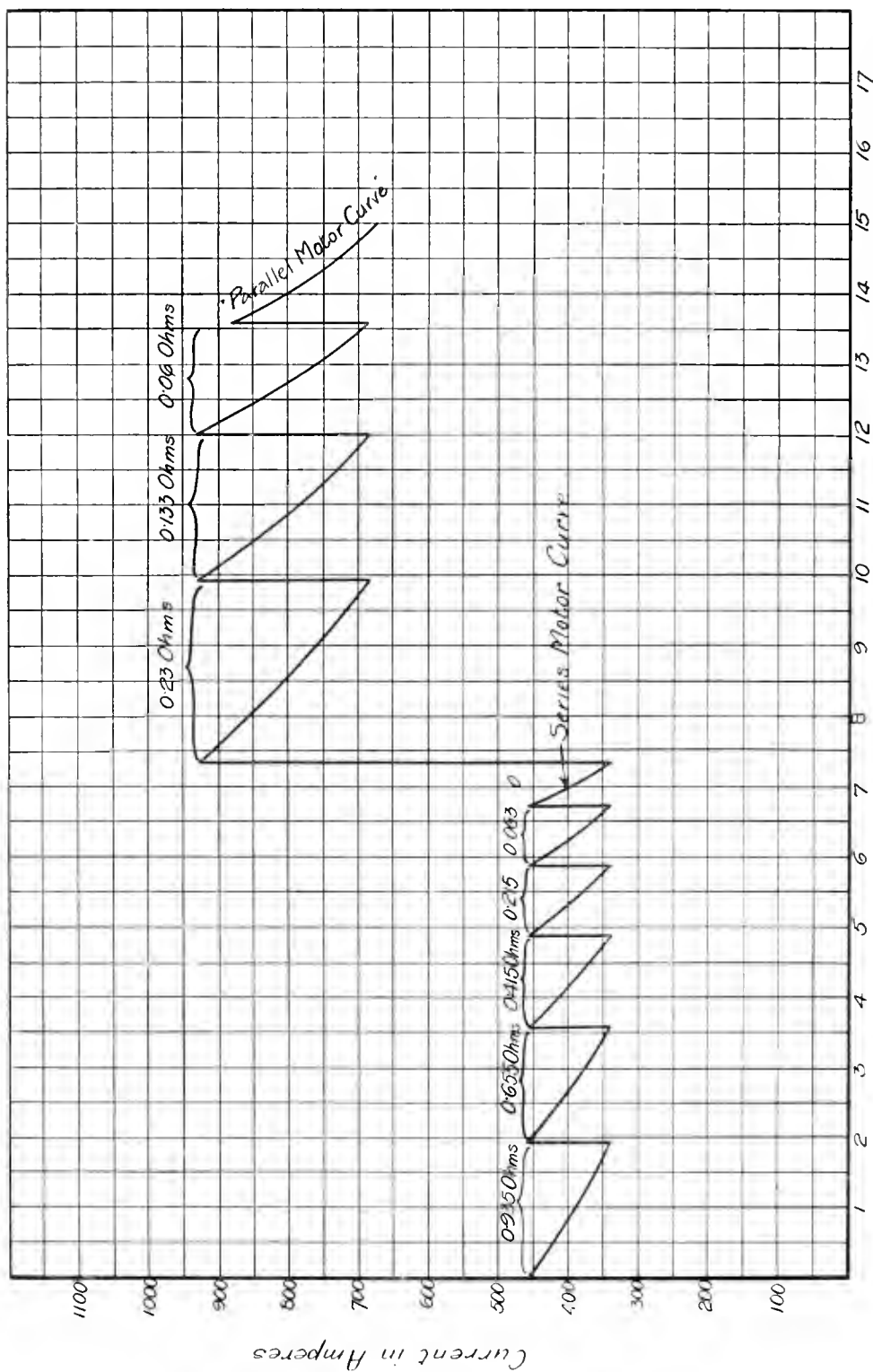

Fig. 76. SERIES PARALLEL OPERATION OF FOUR G.E. 66 A MOTORS.

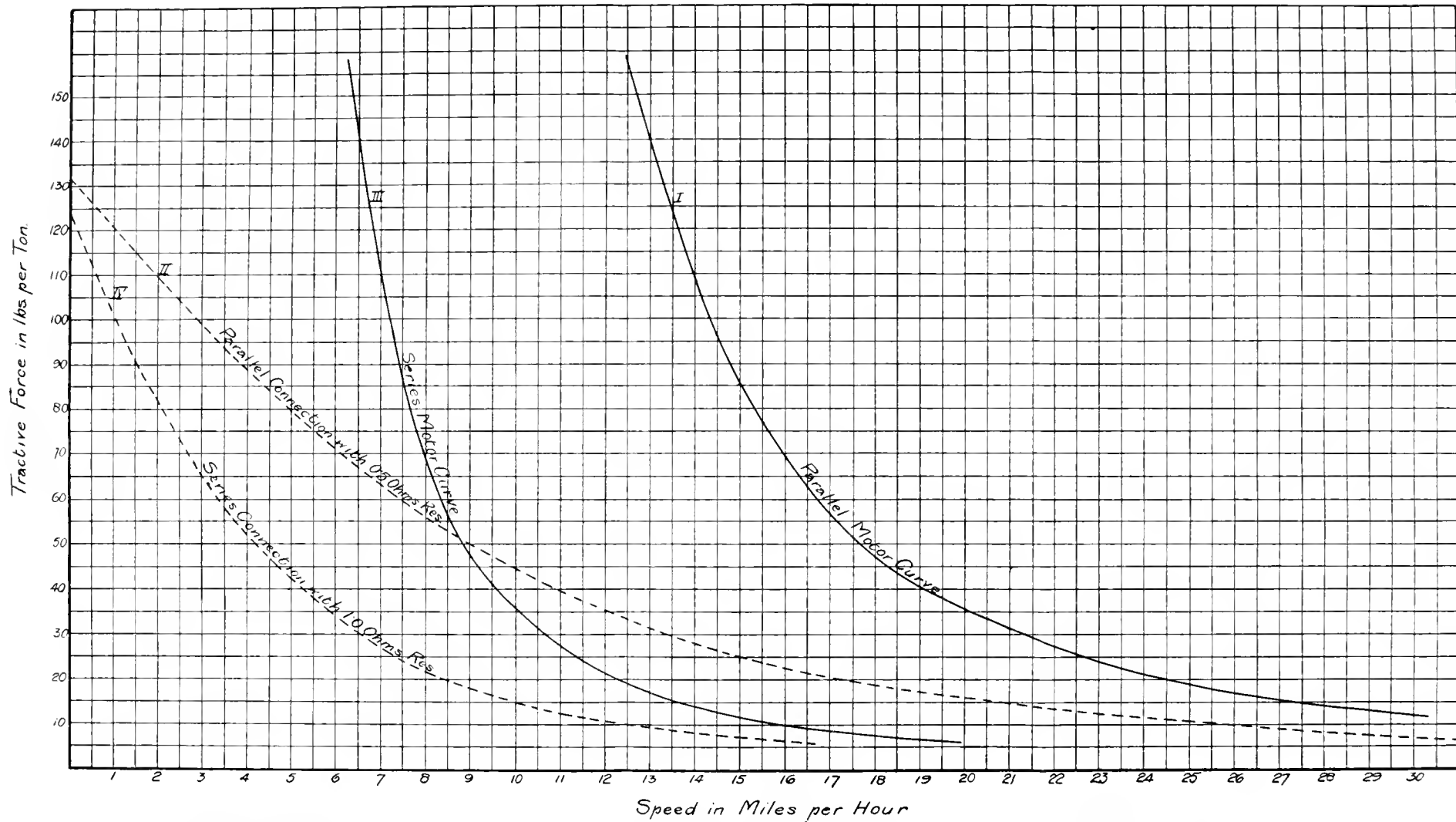
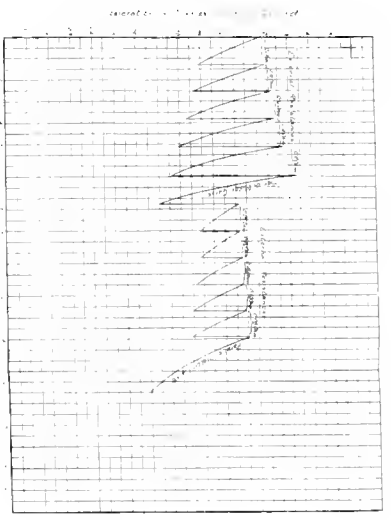
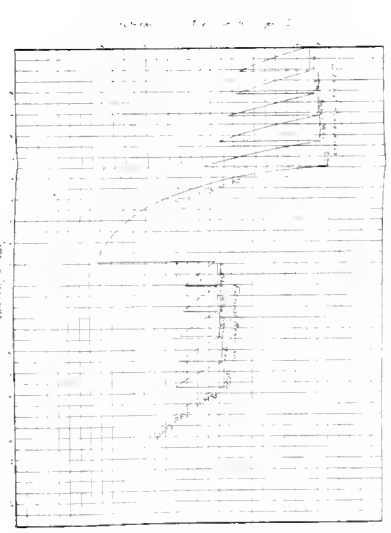

Fig. 77 CHARACTERISTIC CURVES OF SERIES-PARALLEL OPERATION OF FOUR G.E. 66 A MOTORS, WITH A GEAR RATIO OF 3.94, AND WITH 34-INCH DRIVING WHEELS. 125-TON TRAIN. LEVEL TRACK.

Actual speed on Motor from its own motor generator



Actual speed of generator on Motor from its own motor generator



Actual Time Curve

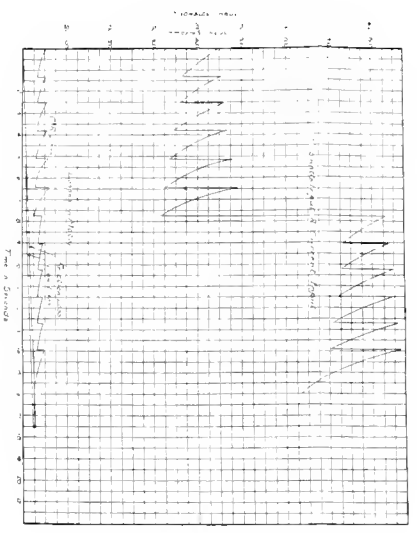

Actual Time Curve

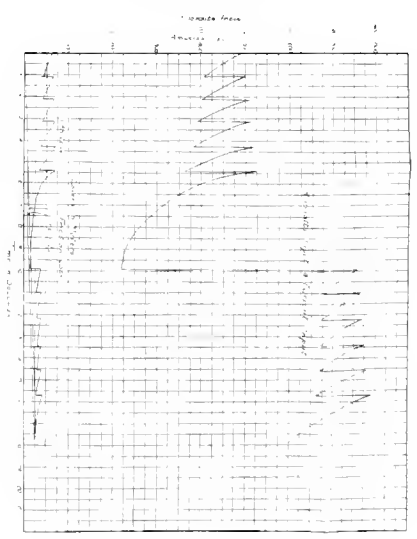

Input Time Curve

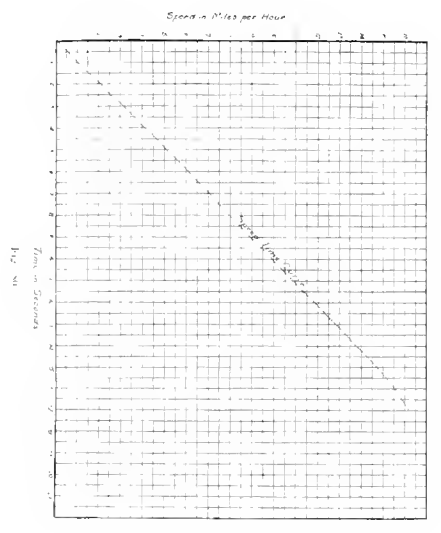

Input Time Curve

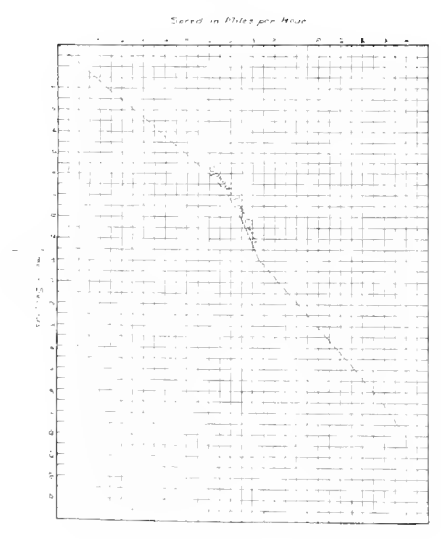

Speed-Time Curve

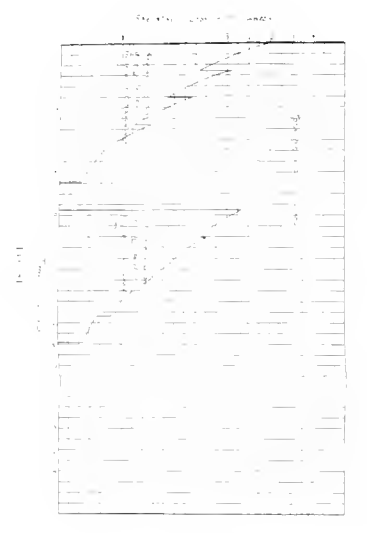

Speed-Time Curve

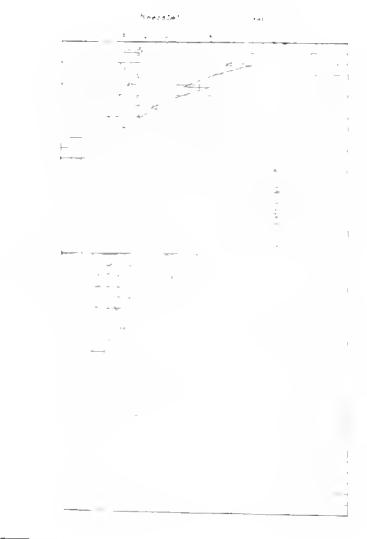

Actual speed on Motor from its own motor generator

Actual speed on Motor from its own motor generator

Actual speed on Motor from its own motor generator



CHARACTERISTICS OF ELECTRIC RAILWAY MOTORS

and the "series" motor curve is reached. This is one of the two most favourable points of operation, for all the rheostats are cut out, and no external losses occur.

Suppose we remain on this point long enough to let the acceleration again drop to the minimum value reached on the preceding point, and that we then switch over to "parallel" connection, the current per motor will again vary between the same limits as for the full "parallel" control, *i.e.*, between 230 amperes and 171 amperes per motor. Figs. 64, 65, and 66, are now taken in their original sense, and we start again at the ordinate for which the abscissa is equal to $7.4 \left(= \frac{14.8}{2} \right)$ seconds. In Fig. 76, the whole period up to the "parallel" motor curve has been plotted. Though in both sections the current *per motor* varies within the same limits, the total current input to all motors will in the first section be exactly half of that in the second section. Up to this point we have taken a variation of the current per motor between fixed maximum and minimum values as the basis on which to build our conclusions. It is clear from Fig. 76 that, in the case of "series-parallel" control, this basis is no longer suitable, since the steps in the total current input would be undesirably large for the "parallel" section, and needlessly small for the "series" section. Moreover, it is distinctly preferable to increase the mean rate of acceleration in the "series" section, and to decrease it in the "parallel" section, in order to decrease the maximum current taken from the station, which, in the case of Fig. 76, is, for the "parallel" section, twice as great as for the "series" section.

Fig. 76 should also be altered so as to increase the time during which the train runs on the first "motor curve," as this is no less favourable than the second "motor curve."

Fig. 61, on p. 65, was used as a means for deriving the speed-time curve with all four motors in parallel. For the more general case of "series-parallel" control, the similar curve sheet shown in Fig. 77 has been prepared. Curves of this sort should be prepared for every design of motor, and consulted in all such cases, as they contain the solutions to various problems connected with the starting of the train. The speeds in miles per hour are plotted as abscissæ, and the tractive force in pounds per ton as ordinates. Four curves are plotted, namely—

- I. "Parallel" motor curve without external resistance;
- II. "Parallel" motor curve with 0.5 ohm external resistance;
- III. "Series" motor curve without external resistance;
- IV. "Series" motor curve with 1.0 ohm external resistance.

These curves are the more useful since the curves for any other external resistances lie proportionately between I. and II., or between III. and IV.

Suppose that we have five steps in the "series" section of the controller, and that the resistance decrease between each step is 0.2 ohms, we can draw in the corresponding curves by simply dividing the horizontal distances between I. and III. into five equal parts.

This has been done in deriving the curves shown in Figs. 78, 79 and 80. The time for each step is taken approximately constant at 1.3 seconds, and we see that the maximum current per step increases slightly for each succeeding step, while the minimum current per step decreases slightly. After switching over to "parallel," the external resistance is 0.25 ohms, and is switched out in steps of 0.05 ohms. The identical rheostat sections employed for the first part, could also be used for the second part by having two rows of resistances successively in series and in parallel. The curves of Figs. 78, 79, and 80 give acceleration, current, and speed plotted against time.

ELECTRIC RAILWAY ENGINEERING

As already pointed out, it is distinctly preferable to increase the rate of acceleration during the "series" period, and to decrease it during the "parallel" period, in order to diminish the maximum current to be supplied by the generating station, as well as in order to relieve the motors, especially as regards commutation, of their severest work. A case in which this plan has been employed has been worked out in Figs. 81, 82, and 83. The total external resistance at starting is 0.9 ohms, and is cut out in approximately equal time intervals and in equal resistance sections, until the point of operation on the "series" motor curve is reached. The motors are permitted to run on this point for a considerably longer time than in the case of Figs. 78 to 80. The resistances employed during "parallel" running are again one-quarter of those used during operation in "series," and are also cut out in equal time intervals and in equal steps. It will be seen that the acceleration during the period of operation with the "series" connection, is about 30 per cent. larger than during operation in "parallel." Figs. 81, 82, and 83 again give acceleration, amperes, and speed as a function of the time in seconds. In Figs. 84 and 85 the rheostatic losses for these two methods are plotted as a function of the time. The curves of Figs. 86 and 87, in which *speeds* are plotted as abscissæ, correspond respectively to the groups of curves of Figs. 78 to 80 and Figs. 81 to 83. Before we compare the two typical methods of Figs. 86 and 87 (methods B and C of Table XX.), let us attempt to simplify the calculations by assuming an infinite number of steps. Fig. 88 is the equivalent of Fig. 86, and Fig. 89 the equivalent of Fig. 87, the only alteration being the assumption of an infinite number of resistance steps.

Table XX. gives a comparison between the five methods:—

(A) parallel control;

(B) series-parallel control, 1 ohm resistance, ten steps;

(C) series-parallel control, 0.9 ohms resistance, ten steps;

(D) series-parallel control, corresponding to B, but with an infinite number of steps;

(E) series-parallel control, corresponding to C, but with an infinite number of steps.

The method of calculating with the assumption of an infinite number of steps (methods D and E of Table XX.) leads to results in nearly all respects equivalent to those obtained by the assumption of a few steps, the principal exception being that the results for the efficiency are slightly—some 3 per cent.—too high. The table shows clearly the advantage of method C as compared with method B. Still more marked is the difference between series-parallel control and parallel control. The case of an infinite number of steps is not an abstract one, but can be realised by liquid starting resistances, as has been done, for instance, on the Valtellina Railway.

With parallel control by method A, the train, in 13.5 seconds, covers a distance of 138 ft., attains a speed of 13.5 miles per hour, and absorbs 1.51 kilowatt-hours. With series-parallel control by method C, the train, in 14.0 seconds, covers a distance of 143 ft., attains a speed of 13.7 miles per hour, and absorbs 1.09 kilowatt-hours. With series-parallel control by method D, the train, in 15.7 seconds, covers a distance of 174 ft., attains a speed of 14.2 miles per hour, and absorbs 1.085 kilowatt-hours. The maximum load on the generating plant in these three cases is 464, 431, and 396 kilowatts respectively. The difference between the first two values (464 and 431), corresponding respectively to methods A and B, is, however, due entirely to the fact that smaller resistance steps are used in the second case than in the first. Between the second and third methods (methods B and C) there is, however, a further decrease of 8 per cent. in the maximum output required from the generating plant per ton weight of train.

CHARACTERISTICS OF ELECTRIC RAILWAY MOTORS

TABLE XX.

Comparison of Five Alternative Methods of Motor Control.

		Method A (Parallel Control).	Method B (Series-parallel Control), 1 Ohm Resistance, Ten Steps.	Method C (Series-parallel Control), 0.9 Ohm Resistance, Ten Steps.	Method D (Series-parallel Control), corresponding to B, but with an Infinite Number of Steps.	Method E (Series-parallel Control), corresponding to C, but with an Infinite Number of Steps.
Rheostatic losses in kilowatt-seconds	During series control . . .	—	616	580	610	571
	During parallel control . . .	2,640	560	397	555	395
	Total during resistance-control period . . .	2,640	1,176	977	1,165	966
Motor losses . . .		480	449	467	455	480
Total losses (rheostatic and motor) kilowatt-seconds		3,120	1,625	1,444	1,620	1,446
Acceleration in miles per hour per second	During series control . . .	—	1.0	1.17	1.05	1.18
	During parallel control . . .	1.0	0.97	0.87	0.97	0.87
	Mean on series motor curve . . .	—	1.0	0.75	0.89	0.72
Distance covered in feet	During series motor curve . . .	—	31	25	34	28
	During parallel control . . .	138	13.6	51.4	9.0	48
	Up to time of parallel motor curve . . .	138	98.7	98	106	111
Time in seconds	During series control . . .	—	143	174	149	177
	During series motor curve . . .	—	6.4	5.4	6.6	5.7
	During parallel control . . .	13.5	1.4	4.6	0.8	4.15
Speed attained in miles per hour	At time when series motor curve commences . . .	—	6.2	5.7	6.6	6.3
	Up to end of series motor curve . . .	—	6.5	6.3	7.0	6.7
	Up to time when parallel motor curve commences . . .	13.5	7.75	9.25	7.75	9.3
Maximum input in kilowatts . . .		464	13.7	14.2	14.2	14.7
Energy consumed by train up to the parallel motor curve	Kilowatt-seconds . . .	464	431	396	390	360
	Kilowatt-hours . . .	5,440	3,920	3,910	4,180	4,135
Energy output from axles, in kilowatt-seconds, up to parallel motor curve . . .		1.51	1.09	1.085	1.16	1.15
Efficiency of system during period of acceleration . . .		2,320	2,295	2,466	2,560	2,689
Time in seconds taken during accelerating period up to parallel motor curve . . .		42%	58%	63%	61%	65%
Mean acceleration from start up to time of commencement of operation on parallel motor curve . . .		13.5	14.0	15.7	14.0	16.1
		1.0	0.98	0.90	1.0	.91

These considerations all refer to the accelerating period only. It is clear, however, that after the time of completion of rheostatic acceleration, there can be no difference between these various methods. The only effect of also taking this latter period into consideration would be to diminish the striking difference existing between these methods when the results are reduced to the basis of energy consumption per ton-mile.

The advantages which we gain by employing, as in method C, a higher rate of acceleration during series control than during parallel control, and by running for a length of time on the series motor curve, are—

- (1) Increase of efficiency and
- (2) Decrease of stress on generating station, motors, rolling stock, and permanent way.

ELECTRIC RAILWAY ENGINEERING

A close study shows that the first advantage can be directly attributed to the longer time at which the train travels on the series motor curve, and the second advantage is due entirely to the lower rate of acceleration during the period of running with the parallel connection. One might make use of the principles underlying method C, to a still greater degree than was done in the case just discussed. For instance, Storer advocates ("Transactions of the American Institution of Electrical Engineers" (1903), Vol. XXIV.) that the total current input to the train during series control should be as great as during parallel control. The authors are, however, of the opinion that such an extreme case introduces grave disadvantages. As the current for the normal starting method is already relatively very high, a 60 to 70 per cent. increase in the current would tend to undue deterioration of the commutator due to the high density at the brush surface area. This would more than offset the gain through reducing the normal current during parallel control. The greater acceleration at the instant of starting, would also be limited in cases of insufficient weight per axle available for adhesion. In the following study we shall neglect altogether any advantage that may be gained by thus improving the efficiency during the accelerating period, and shall simply use the normal accelerating method for an infinite number of controller steps. The simplification thus introduced will facilitate a close examination into the period following the completion of rheostatic acceleration.

In a former chapter, the speed-time curve has been developed graphically, and the elementary principles of coasting and braking have been explained, always on the assumption of a level track. A shorter, though somewhat less accurate, method, based on tabular calculations, will now be given, and the following important relations will be considered:—

- (1) Influence of coasting or "drifting";
- (2) Influence of gradients.

On a straight level section of $\frac{1}{2}$ -mile length, a 120-ton train, equipped with four G.E. 66 A motors, the characteristic curves of which have been given in Fig. 50 (on p. 56), is accelerated at the rate of 1 mile per hour per second. We shall first assume that no coasting takes place.

The speed intervals into which the calculation has been divided, are set forth in column 1 of Table XXI. After the completion of rheostatic acceleration, that is, at a speed of 14.1 miles per hour, for which the rate of acceleration on the "parallel" motor curve is 1.0 mile per hour per second, the speed limits in column 1 are raised by increments of 1 mile per hour. Column 2 gives the tractive force exerted by the four motors at the average speed during each interval, the values being obtained by reference to Fig. 77, as already explained. Column 3 gives the train resistance, for which, in lieu of more accurate information, values corresponding with observations on the Central London Railway (see Fig. 6, on p. 9) have been employed. The values in column 4 are the sum of the values in columns 2 and 3, while column 5 gives at once the rate of acceleration in miles per hour per second by simply dividing by 100 the values in column 4. The values in column 6 are obtained by dividing the speed intervals in column 1 by the average accelerations during these intervals. The values in column 7 are obtained by multiplying the average speed by the time and by the constant 1.47.

Six Steps and Six Parallel Positions of Controller

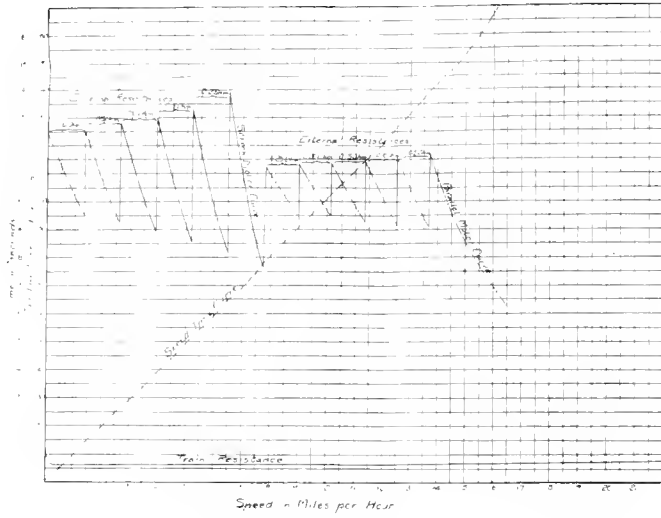

Fig. 86
(Method B of Table XX.)

Infinite Number of Controller Positions

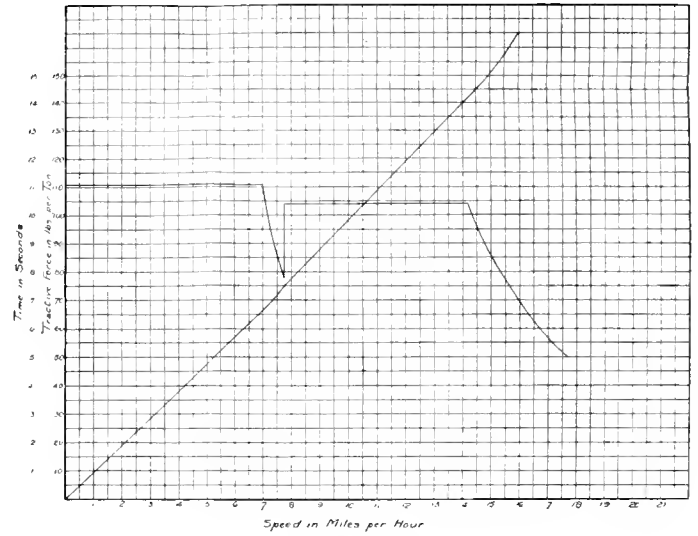

Fig. 88
(Method D of Table XX.)

No time spent on Motor Curve prior to going into parallel

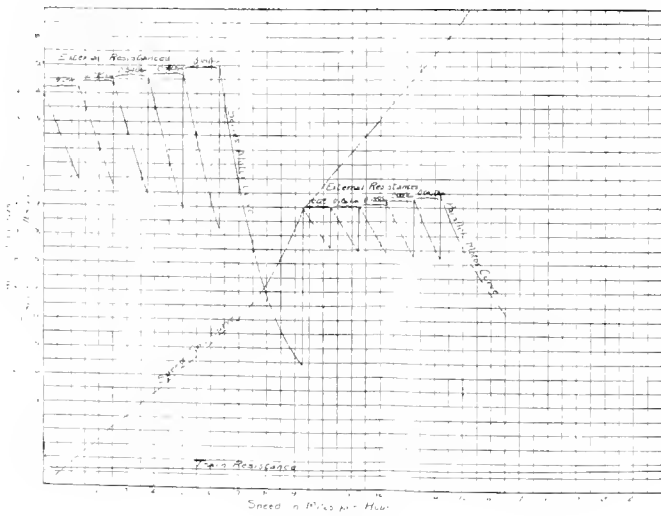

Fig. 87
(Method C of Table XX.)

Time spent on Motor Curve prior to going into parallel

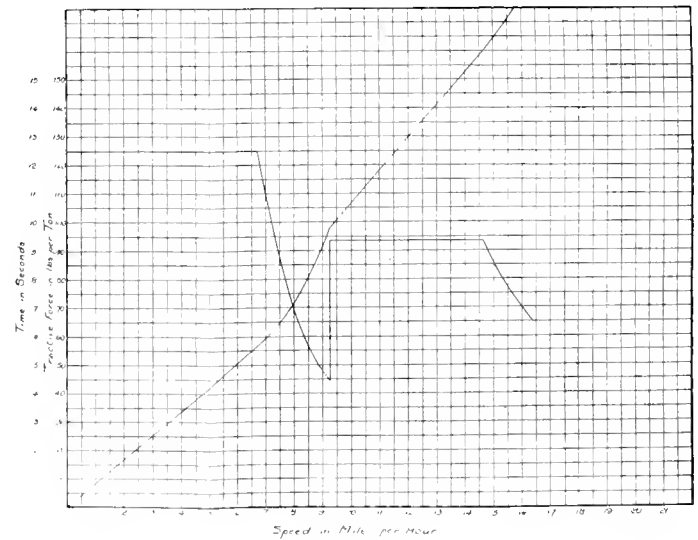

Fig. 89
(Method E of Table XX.)



CHARACTERISTICS OF ELECTRIC RAILWAY MOTORS

TABLE XXI.

Calculations for a $\frac{1}{2}$ -mile run at an Average Speed of 19 miles per hour, 120-Ton Train, Level Track.

Column 1, Speed Intervals. (The Speed is expressed in Miles per Hour.)	Column 2, Tractive Force exerted by Motors in Pounds per Ton	Column 3, Tractive Resist- ance in Pounds per Ton.	Column 4, Resultant Accelerating Force in Pounds per Ton.	Column 5, Rate of Acceler- ation in Miles per Hour per Second.	Column 6, Time in Seconds.	Column 7, Distance in Feet.
0-14.1	106	-6	100	1.0	14.1	147
14.1-15	96	-6.5	89.5	0.895	1.0	21
15-16	78	-6.5	71.5	0.715	1.4	33
16-17	63	-7	56	0.56	1.8	45
17-18	52	-7	45	0.45	2.2	57
18-19	44	-7	37	0.37	2.7	72
19-20	38	-7.5	30.5	0.305	3.3	96
20-21	34	-7.5	26.5	0.265	3.8	114
21-22	29	-8	21	0.21	4.7	147
22-23	26	-8	18	0.18	5.5	183
23-24	23	-8	15	0.15	6.7	234
24-25	20	-8.5	11.5	0.115	8.7	312
25-26	18	-8.5	9.5	0.095	10.5	390
26-26.9	16.5	-9	7.5	0.075	11.5	450
26.9-0	-150	-7	-157	-1.57	17.1	340
					95.0	2,640

Average speed from start to stop = 19 miles per hour.
 Total watt-hours energy input to train = 4,370.
 Energy input to train in watt-hours per ton-mile = 72.7.

From these figures we obtain the speed time curve plotted in Fig. 90, in which the current input during this period has also been plotted. We have 72.7 watt-hours per

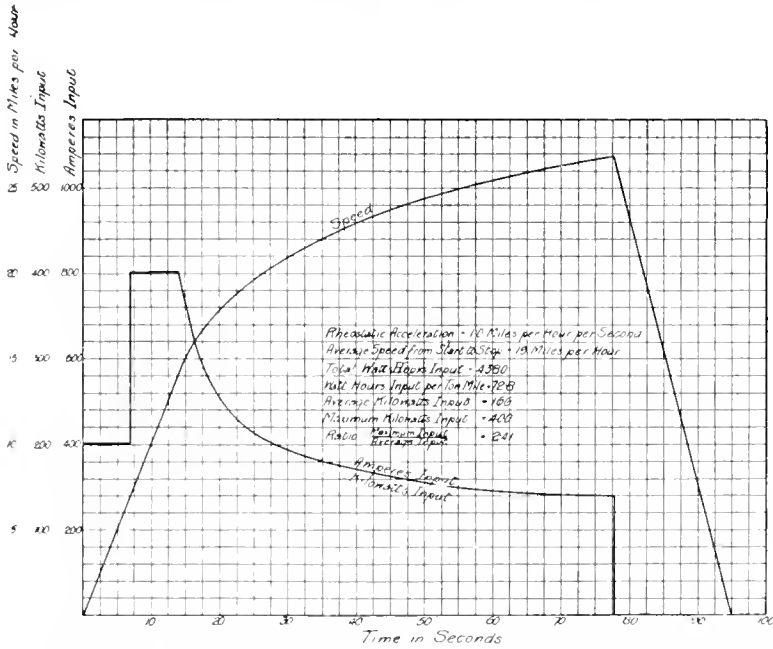

Fig. 90. CHARACTERISTIC CURVES FOR A $\frac{1}{2}$ -MILE RUN AT AN AVERAGE SPEED OF 19 MILES PER HOUR, 120-TON TRAIN, LEVEL TRACK, NO COASTING.

ton mile and an average speed of 19 miles per hour. The curves of Figs. 91, 92, and 93 have been obtained by similar calculations. In these cases, however, coasting for

ELECTRIC RAILWAY ENGINEERING

various lengths of time has been employed. The results have been brought together in Table XXII. It will be seen that the watts input per ton-mile decrease at a

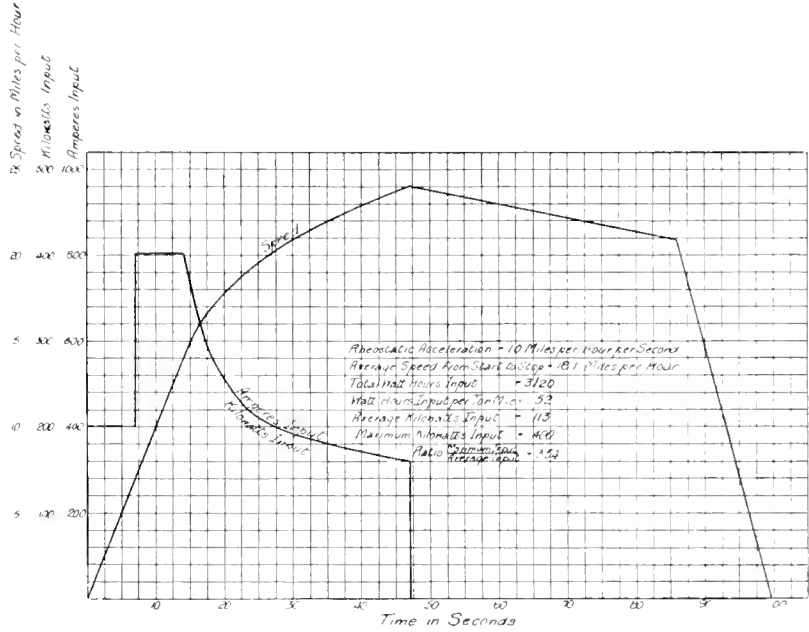

Fig. 91. CHARACTERISTIC CURVES FOR A $\frac{1}{2}$ -MILE RUN AT AN AVERAGE SPEED OF 18.1 MILES PER HOUR. 120-TON TRAIN. LEVEL TRACK. COASTING FOR 39 SECONDS.

considerably greater rate than the average speed. The value 28.5 watt-hours per ton-mile for an average speed of 13.4 miles per hour, and two stops per mile, may be

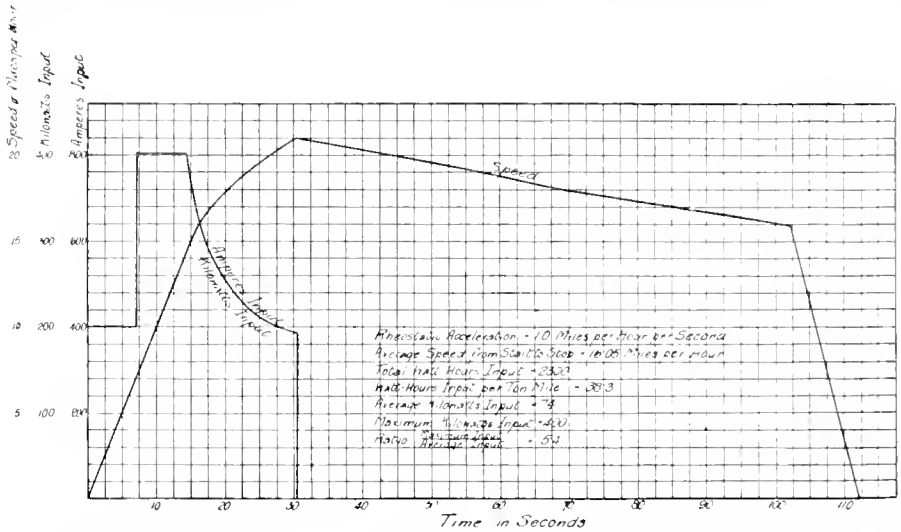

Fig. 92. CHARACTERISTIC CURVES FOR A $\frac{1}{2}$ -MILE RUN AT AN AVERAGE SPEED OF 16.1 MILES PER HOUR. 120-TON TRAIN. LEVEL TRACK. COASTING FOR 72 SECONDS.

considered very small indeed. It would, however, be quite impracticable to employ such a large amount of coasting, and this is due to the high momentary maximum loads that would be thereby incurred.

CHARACTERISTICS OF ELECTRIC RAILWAY MOTORS

TABLE XXII.

Comparison of Results of $\frac{1}{2}$ -mile Runs with various Periods of Coasting.
Acceleration = 1 mile per hour per second in all cases. 120-Ton Train. Level Track.

Number of Seconds from Start to Commencement of Coasting.	Distance in Feet from Start to Commencement of Coasting.	Average Speed from Start to Stop in Miles per Hour.	Energy Input to Train in Watt-hours per Ton-mile.	Average Kilowatt Input to Train.	Maximum Kilowatt Input to Train.	Ratio of Maximum to Average Input.
No coasting	No coasting	18.95	72.7	166	400	2.4
47.2	1,149	18.10	52.0	113	400	3.5
30.3	585	16.05	38.3	74	400	5.4
20.5	303	13.38	28.5	46	400	8.7

By increasing the rate of acceleration at starting, the same average speed may be obtained for various intervals of coasting. This has been done in the curves of Figs.

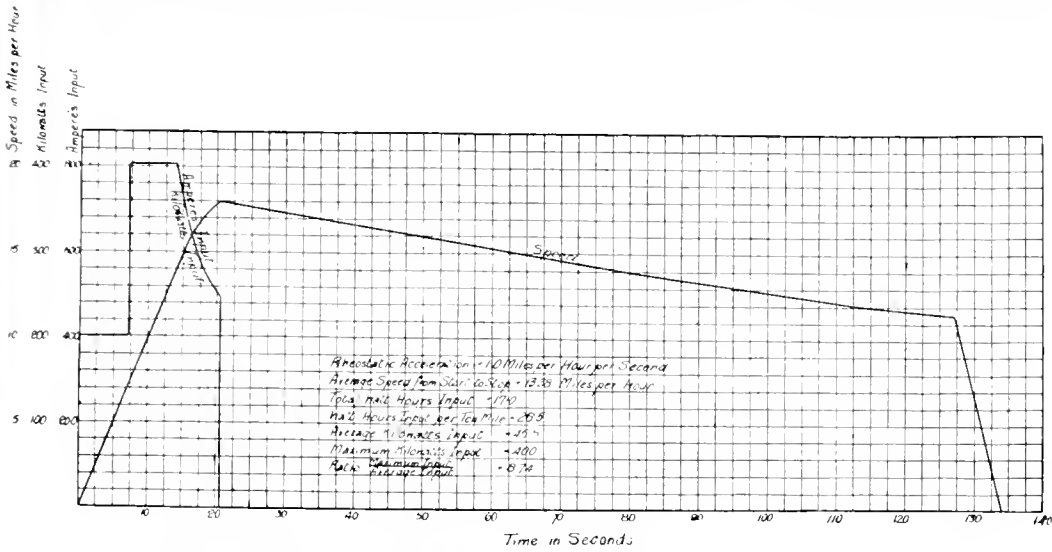

Fig. 93. CHARACTERISTIC CURVES FOR A $\frac{1}{2}$ -MILE RUN AT AN AVERAGE SPEED OF 13.4 MILES PER HOUR. 120-TON TRAIN. LEVEL TRACK. COASTING FOR 107 SECONDS.

94 and 95 for a mean speed of 19 miles per hour, and the results, together with those corresponding to Fig. 90, are given in Table XXIII.

TABLE XXIII.

Comparison of Results of $\frac{1}{2}$ -mile Runs at an Average Speed of 19 Miles per hour, and with various Periods of Coasting. 120-Ton Train. Level Track. Varying rates of Acceleration.

Rate of Acceleration in Miles per Hour per Second.	Number of Seconds from Start to Commencement of Coasting.	Distance in Feet from Start to Commencement of Coasting.	Average Speed in Miles per Hour.	Energy Input to Train in Watt hours per Ton-mile.	Average Kilowatt Input to Train.	Maximum Kilowatt Input to Train.	Ratio Maximum Input to Average Input.
1.0	No coasting	No coasting	19	72.8	166	400	2.4
1.2	37.5	1,548	19	60.8	139	460	3.3
1.4	49.3	1,344	19	56.0	127	520	4.1

ELECTRIC RAILWAY ENGINEERING

In this comparison the same motor curve has been taken for all cases. A similar comparison might be made in which different motor curves are used, the mean speed and rate of acceleration remaining the same. Our principal purpose is, however, to show that for higher accelerating rates, the watt-hours per ton-mile are slightly reduced. Carter, in a letter to *Engineering* for June 2nd, 1905, writes:—

“Paradoxical as it may appear, if a given schedule is to be maintained, the higher the rate of acceleration the lower will be the energy consumption per ton-mile. The reason, however, is not far to seek. The energy input is employed partly in doing work against train resistance, and partly in imparting kinetic energy to the train, which is ultimately dissipated through braking. The former component amounts to 2 watt-hours per ton-mile output for every pound per ton train resistance, say $2\frac{1}{4}$ watt-hours per ton-mile output. The latter component, which, in the case of suburban service, may amount to two-thirds or more of the total energy consumption, varies practically as the square of the speed when the brakes are applied, as the weight of the train, and as the frequency of the stops. A higher rate of acceleration therefore results in reduced energy consumption, since it becomes possible to maintain the schedule with a lower maximum speed, therefore dissipating less energy in braking.”

The authors wish at this point to refer to the ratio between maximum input to train and average input to train. This consideration has a most important bearing on the choice of the rate of acceleration to be employed. In the three cases given in Table XXIII. (on p. 79) the maximum input to train is respectively 400, 460, and 520, while the average input is 166, 138, and 127. The ratio between maximum to average input has therefore the values 2.41, 3.32, and 4.1 for an acceleration of 1, 1.2, and 1.4 miles per hour per second.

In all those cases where the number of trains running at the same time are few, the above ratio plays an important *role* in so far as the rated output of the generating station and of the sub-stations is determined by the maximum output. In all these cases it would be bad policy to use a high accelerating rate, as this is associated with a high ratio of maximum input to average input. For all those cases, however, where the number of trains is great, the value of the maximum input to a single train does not occasion great fluctuation in the demand on the generating station, and, therefore, a higher rate of acceleration is desirable. Of course, there is still the disadvantage that the motors, rolling stock, and permanent way are subjected to more severe maximum stresses.

We shall now explain a method by which the gradients may be taken into account. The method enables us to ascertain the extent to which they influence the energy consumption. The influence of a down gradient is added to the tractive force exerted by the motor, and that of an up gradient is in opposition to it. As a down gradient of 100 per cent., *i.e.*, a direct fall, produces a rate of acceleration of 22 miles per hour per second, or a tractive force of 2,200 lbs. per ton, a gradient of 1 per cent. will produce a tractive force of 22 lbs. per ton. It is, therefore, quite permissible to forthwith ascribe to the gradients the tractive force in pounds per ton corresponding to the acceleration which they produce. Thus a 1 per cent. up grade, for example, is equivalent to a tractive force of -22 lbs. per ton, and a $\frac{1}{2}$ per cent. down grade to +11 lbs. per ton.

We shall again consider a $\frac{1}{2}$ -mile section, the first 300 ft. of which have a gradient of +60 lbs. per ton, and the last 300 ft. a gradient of -60 lbs. per ton. The remainder of the distance is level. The calculation may be carried out tabularly, as set forth in Table XXIV. The results have been plotted in Fig. 96.

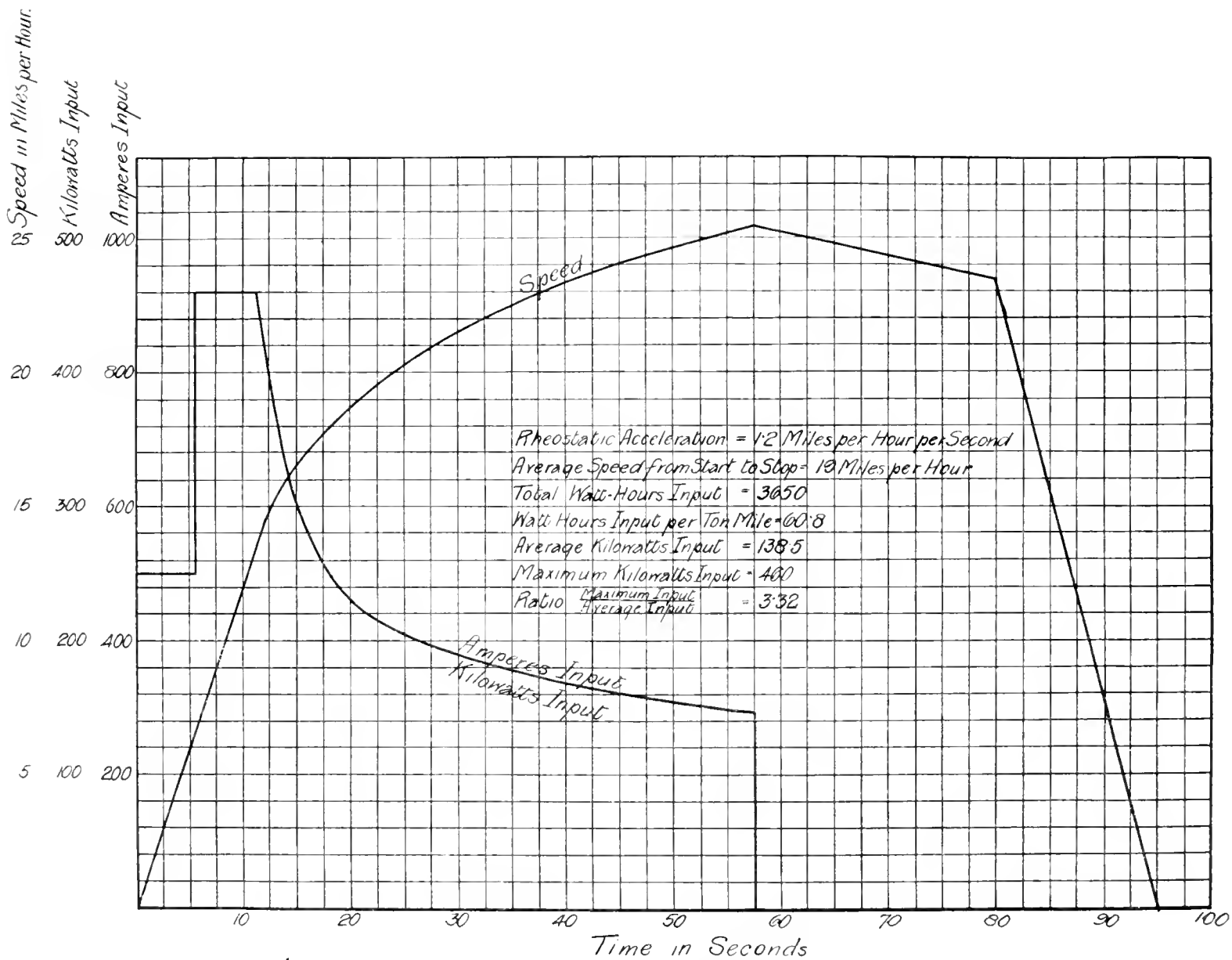

FIG. 94. CHARACTERISTIC CURVES FOR HALF-MILE RUN AT AN AVERAGE SPEED OF 19 MILES PER HOUR AND WITH COASTING FOR 23 SECONDS, 120-TON TRAIN, LEVEL TRACK.

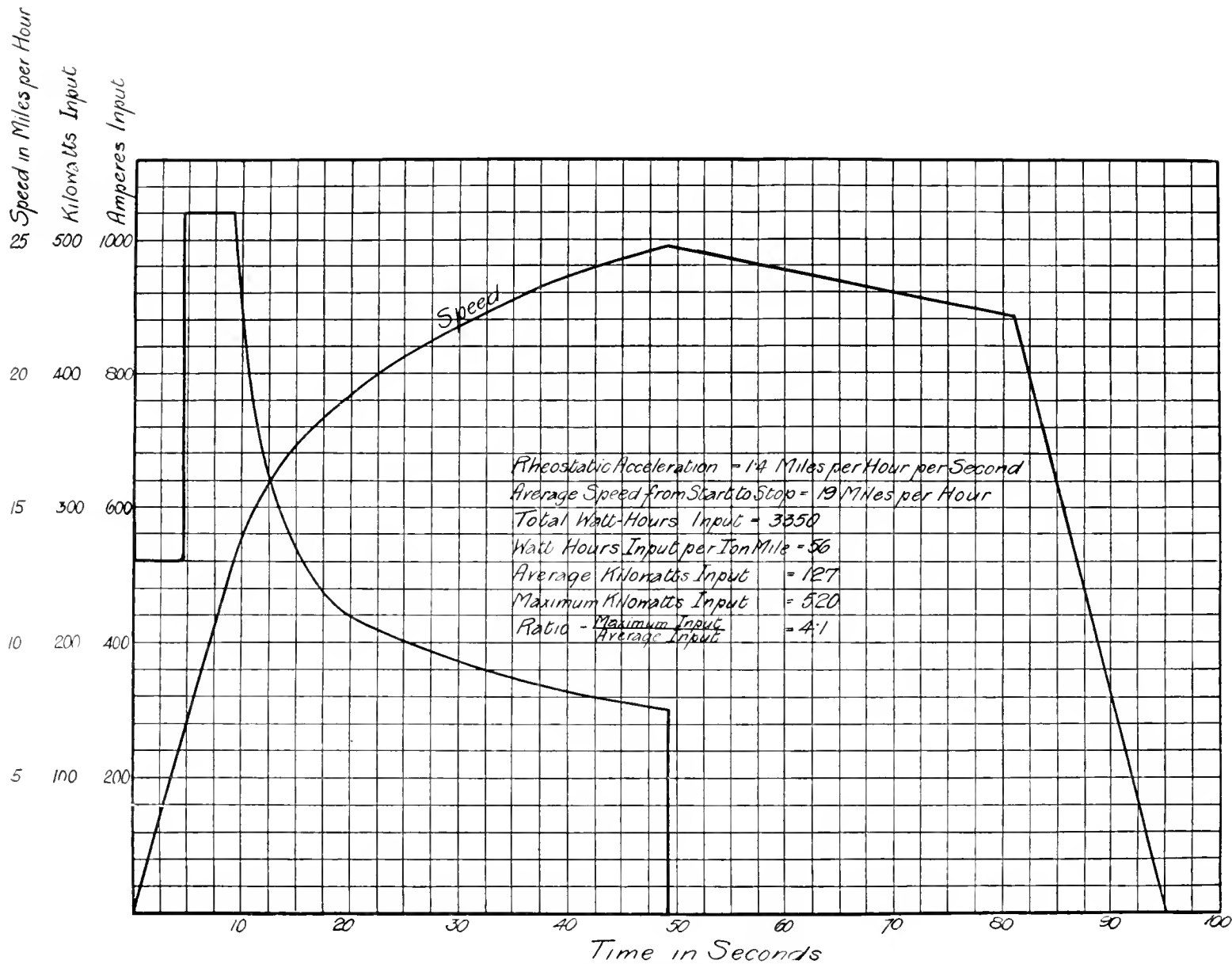

Fig. 93. CHARACTERISTIC CURVES FOR HALF-MILE RUN AT AN AVERAGE SPEED OF 19 MILES PER HOUR, AND WITH COASTING FOR 32 SECONDS. 120-TON TRAIN. LEVEL TRACK.

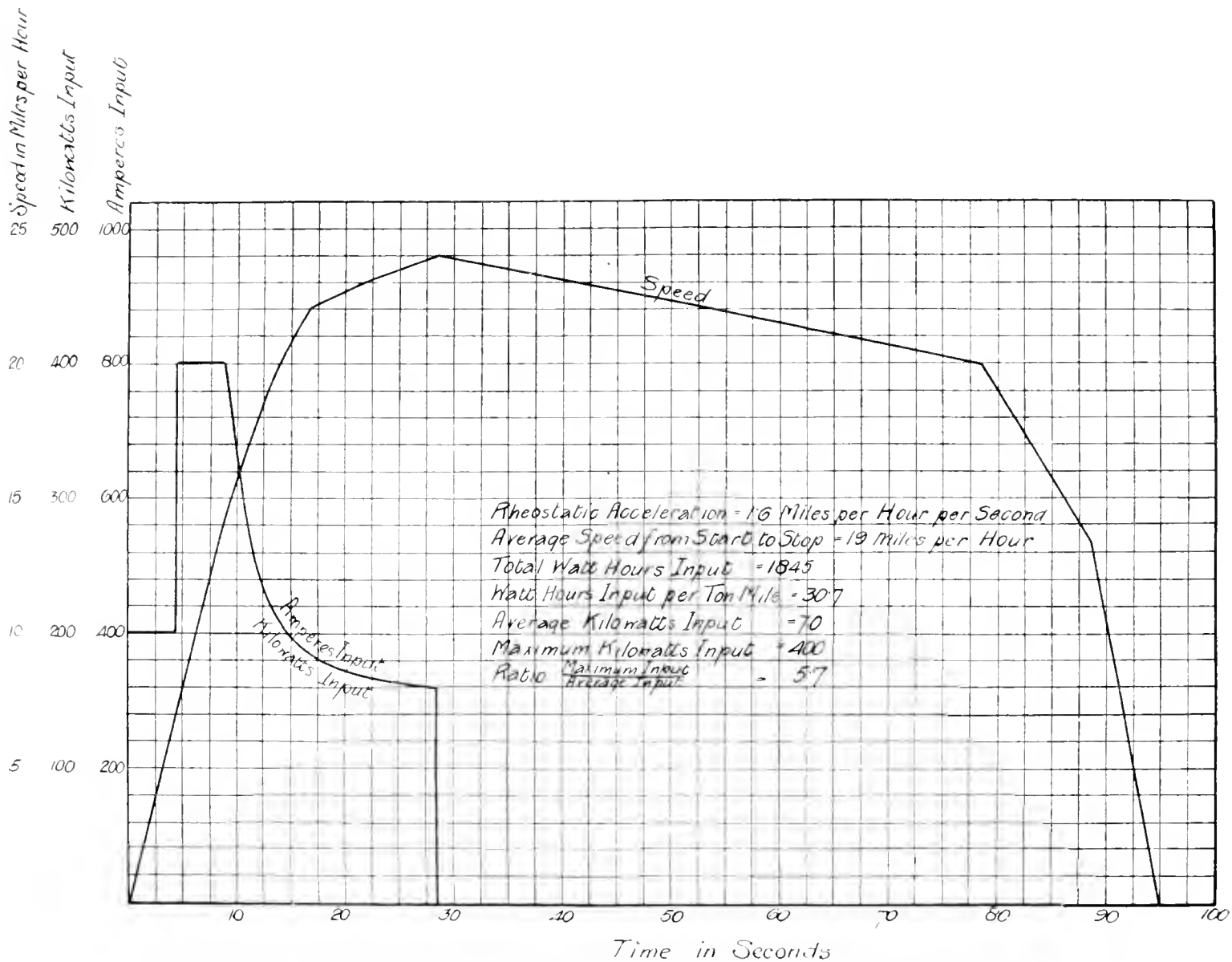

Fig. 96. CHARACTERISTIC CURVES FOR A HALF-MILE RUN AT AN AVERAGE SPEED OF 19 MILES PER HOUR. 120-TON TRAIN. GRADES AS SET FORTH IN TABLE XXIV.



CHARACTERISTICS OF ELECTRIC RAILWAY MOTORS

TABLE XXIV.

Calculations for Operation of a 120-Ton Train at an average Speed of 19 Miles per Hour, over a $\frac{1}{2}$ -Mile Section, with a 2.73 per Cent. Down Gradient for the first 300 Feet, and a 2.73 per cent. Up Gradient for the last 300 Feet.

Speed.	Tractive Force exerted by Motors in Pounds per Ton.	Tractive Force exerted by Gradient in Pounds per Ton.	Train Resistance in Pounds per Ton.	Resultant Acceleration in Miles per Hour per Second.	Time in Seconds.	Distance in Feet.
0-14.1	106	+60	-6	1.6	8.8	91
14.1-15	96	+60	-6.5	1.485	7.6	12
15-16	78	+60	-6.5	1.315	8	18
16-17	63	+60	-7	1.16	9	21
17-18	52	+60	-7	1.05	9	24
18-19	44	+60	-7	0.97	1.0	27
19-20	38	+60	-7.5	0.905	1.1	30
20-21	34	+60	-7.5	0.865	1.2	36
21-22	29	+60	-8	0.81	1.2	39
22-23	26	0	-8	0.18	5.5	182
23-24	23	0	-8	0.15	6.7	231
24-23	0	0	-8	-0.08	12.5	432
23-22	0	0	-8	-0.08	12.5	414
22-21	0	0	-8	-0.08	12.5	396
21-20	0	0	-8	-0.08	12.5	387
20-13.3	0	-60	-7.5	-0.675	9.8	240
13.3-0	-150	-60	-6	-2.16	6.2	60
					94.7	2,640

Mean speed from start to stop = 19.0 miles per hour.
Input to train in watt-hours per ton-mile = 39.7.

This value of 39.7 watt-hours input to the train per ton-mile should be compared with the values in Table XXIII. The comparison shows that by a suitable use of this method, great economies are possible in many cases. To obtain the full saving possible, the use of the brakes should be reduced to a minimum. This condition is often not complied with on such roads. One often observes that the motorman keeps on power part way up the grade approaching the arrival platform, and then cuts off the current and applies the brakes. When such methods are permitted, a large part of the possible saving is sacrificed. The percentage of possible saving by the use of gradients at the stations, is greater the greater the number of stops, and the higher the schedule speed. It would not be worth while providing gradients for this purpose on lines with infrequent stops. These gradients are considerably more effective than any schemes for regenerating, for the reason that with gradients the recovery of the energy represented by the momentum of the train is effected without the aid of the motor, *i. e.*, without heating the motor, and it follows directly that the size of the motor can be considerably smaller than in any regenerative control system.

Having shown how to obtain the characteristics relating to each section of a railway and how to deduce the average power required corresponding to the average speed, the average distance between stops, the profile of the line, and the number of trains, we propose to refer briefly to what is known as the load characteristic. It is often necessary to ascertain not only the average load but the nature and extent of the fluctuations, for the proper proportioning of the generating station plant and sub-station plant. These are obtained by superimposing the several section characteristics, and then adding the ordinates, the intervals corresponding to the frequency of service.

ELECTRIC RAILWAY ENGINEERING

In this way the load characteristic is obtained for a particular number of trains. It is usual to construct the curve for the maximum number of trains, and, after allowing for losses in transmission and transformation, we obtain the conditions to be fulfilled by the generating plant.

We must next consider the choice of the motor and of the gear ratio. The size of the motor, so far as relates to its rated output, is mainly dependent upon the heating due to the internal losses. The actual size of the motor, however, *i.e.*, its weight, is also dependent upon the speed, *i.e.*, upon the gear ratio and upon the diameter of the driving wheels. Increasing the gear ratio in any particular motor, decreases the train speed and increases the tractive effort both in the same ratio, the current being assumed constant.

In Fig. 97 are given the characteristic curves of the G.E. 66 A. motor for three different gear ratios.¹ Curves corresponding to those in Fig. 77 can be plotted for other gear ratios in this same way. Fig. 98 shows how the transformation is obtained for a 20 per cent. greater gear ratio than that corresponding to the curves in Fig. 77. Any alteration in the diameter of the wheels should be treated as equivalent to an alteration in the gear ratio, an increase in the wheel diameter being equivalent to a decrease of the gear ratio. For instance, if we go over from a gear ratio of 5.1 to 1 and a wheel of 33 ins. diameter to a gear ratio of 2.7 to 1 and a wheel of 45 ins. diameter, the equivalent alteration is

$$\frac{5.1 \times 45}{2.7 \times 33} = 2.58.$$

For a given current, the train speed increases in the ratio of 1 to 2.58, and the torque decreases in the ratio of 2.58 to 1.

The method of estimating the temperature rise of a motor must be selected with reference to the particular case in hand. In the present discussion we shall have occasion to refer more particularly to those cases where the time interval from start to stop is small, so small that the temperature rise during one such interval can be neglected compared with the total temperature rise of the motor after several trips. In such a case we may calculate the copper and iron losses during one run (as has been done in Figs. 79 and 82), and thus obtain the average loss, which we express in watts. The temperature rise is then obtained from the results of tests made with such constant loads as correspond to this value for the average watts dissipated in the motor. For preliminary calculations it is usual to estimate the size of the motor from the average load of the motors. This may introduce slight errors, since the losses during this average load will generally be different from the average losses, but the error is not very great, and, with a little experience in making allowance for this error, this simple method can also be used for the final calculation. In cases where the average time from start to stop is greater, and a consideration of the heating during a single run from start to stop becomes necessary, one nevertheless first calculates the heating as before. In addition one must, in this case, take into consideration the variation in the final temperature during a single run from start to stop. The temperature fluctuates even after having attained its final mean value, in the way indicated in Fig. 99, in which it is seen that a heating period alternates with a cooling period. The maximum temperature is therefore greater than the average temperature by approximately half the difference between A and B. The distance

¹ The ratios chosen, *i.e.*, 2, 3, and 4, allow a good comparison; it is scarcely necessary to point out that the precise values are not such as should be employed in practice.

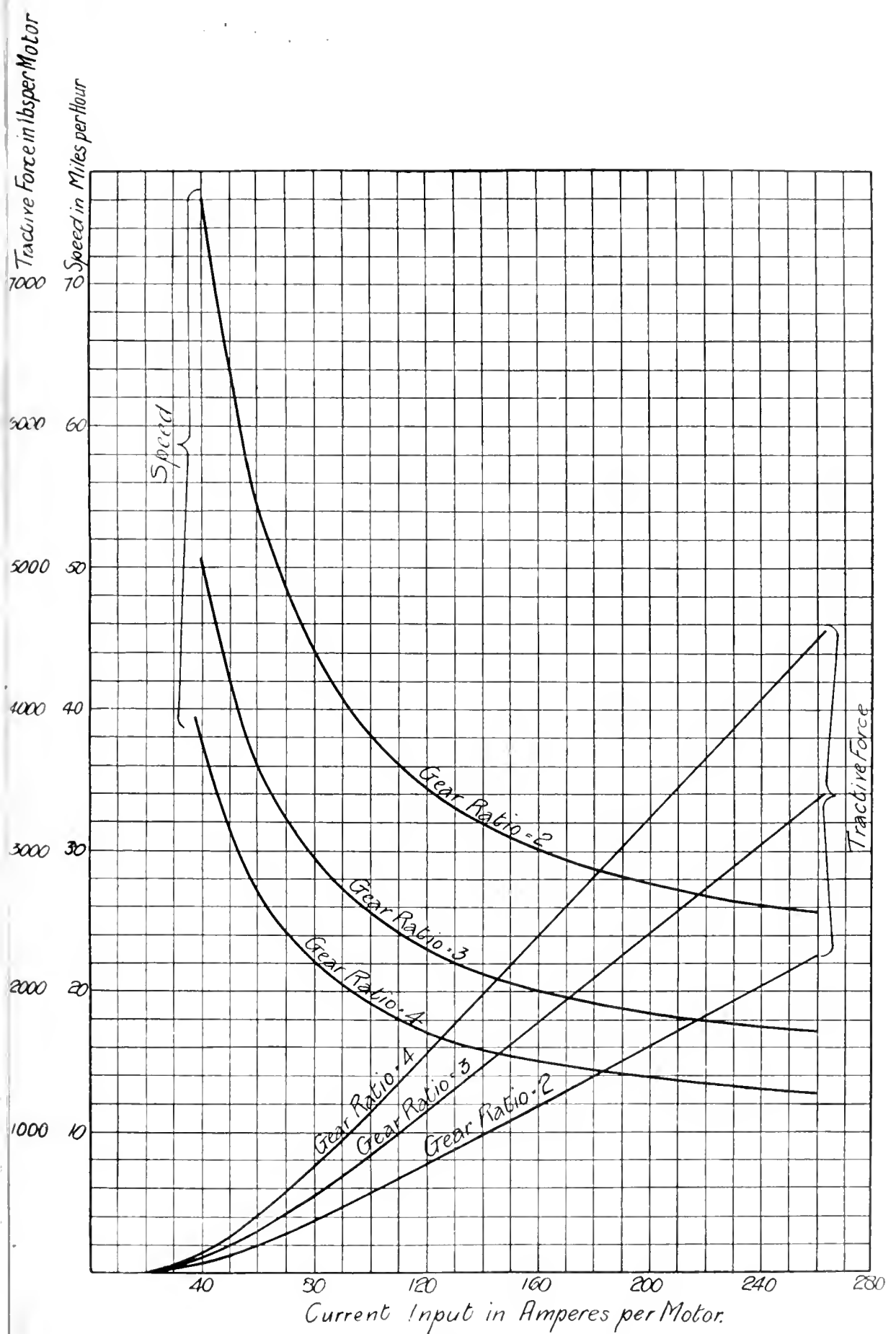

Fig. 97. CHARACTERISTIC CURVES OF G.E. 66 A. MOTOR FOR THREE DIFFERENT GEAR RATIOS.

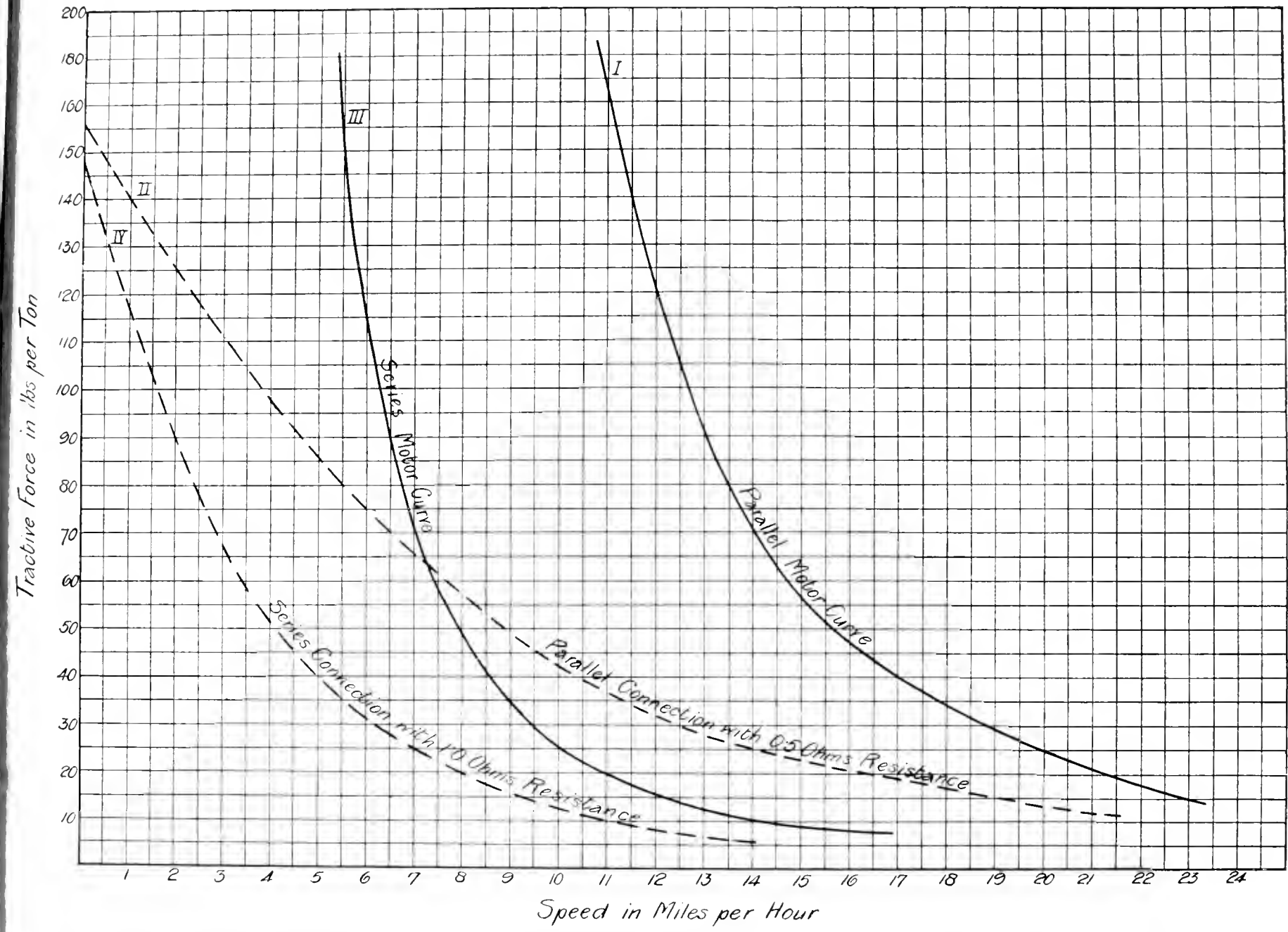

Fig. 98. CHARACTERISTIC CURVES OF SERIES PARALLEL OPERATION OF FOUR G.E. 66 A. MOTORS WITH A GEAR RATIO OF 4.73, AND WITH 34-INCH DRIVING WHEELS. 125-TON TRAIN. LEVEL TRACK.



CHARACTERISTICS OF ELECTRIC RAILWAY MOTORS

A B can be estimated fairly accurately from the cooling curve determined during the complete tests on the motor, as all the necessary factors, such as time of cooling and average temperature, are given. The temperature rise of the motor from the commencement of service would follow the curve of Fig. 100, from which we see that it increases by steps as section after section of the route is traversed.

The problem that next arises, consists in applying to practical conditions the various results deduced in the preceding sections. This general case relates to a route with a number of stations located at varying distances apart, the gradients on each single section also varying. The schedule speed for a total train trip, the approximate weight of the train, and the duration of the stops are also generally given. Before determining the capacity of the motor and the required motor characteristics, we must ascertain the average distance between stations and the average profile of the line and estimate from these and the other necessary data the consumption in watt-hours per ton-mile. While the calculation of the average distance between stations offers no difficulty, the average profile of the line is not so

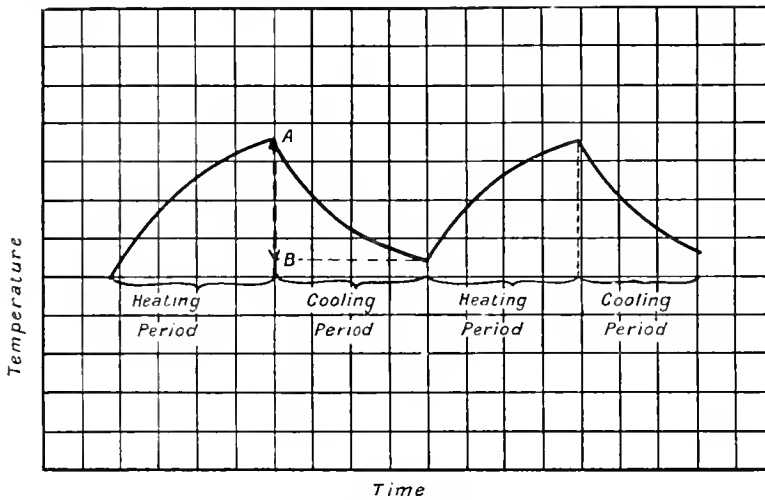

Fig. 99. TYPICAL TEMPERATURE CURVE OF AN INTERMITTENTLY-LOADED MOTOR.

readily ascertained. In fact, this step is sometimes neglected altogether in the preliminary calculation.

We propose to give a more detailed description of our method for obtaining the average profile of the line, because the importance of this factor is often great. In very many cases the accuracy obtained from the study of a single representative section is sufficient for the final estimation of the required motor characteristics. If the average profile is not taken into account, the final and rather laborious calculation may show that the preliminary calculations have led to incorrect conclusions as to the motor characteristics required, and all the laborious calculations will then have to be repeated. If all single sections have approximately the same profile, then, of course, the average profile is immediately available. In the general case, however, it is necessary to ascertain the degree of importance of the gradients and of their location. Such an analysis, as indicated in Table XXIV. on p. 81, would show that an up gradient at the beginning of a run is of the greater disadvantage, and that the effect is diminished if the location of the gradient is removed from the beginning nearer to the end of the accelerating period, and still further diminished if nearer to the end of the run. In

ELECTRIC RAILWAY ENGINEERING

fact, at the very end of the run an up gradient becomes advantageous, since it relieves the brakes. The effect of any gradient may, therefore, be fairly represented as a function of the amount of that gradient and of its location.

Suppose that we have a line where the distance between stations varies between one-third of a mile and one and one-half miles. From a rough consideration of the mean speed and the practicable rate of acceleration, we find that the accelerating period may extend to a distance of from 200 to 500 ft., and the braking period to from 150 to 250 ft. In Table XXV., the gradients for the three principal stages of each single run between stations are recorded.

- I. The average gradient for the first 300 ft.
- II. " " " " second 300 ft.
- III. " " " " last 200 ft.

To each gradient is assigned at once its equivalent value in tractive force in lbs. per ton. An up-gradient is indicated as negative (-), and a down-gradient as positive (+).

TABLE XXV.

Schedule of Gradients on the various Sections of the Railway.

Run.	Average Gradient for first 300 Feet.	Average Gradient for second 300 Feet.	Average Gradient for last 200 Feet
From station A to station B	+20	+15	+5
From B to C	+10	+3	+11
From C to D	-5	-8	+20
From D to E	-6	-3	-15
From E to F	+30	+10	-5
From F to G	-20	+10	-25
Average A to G	+5	+4.5	-2

From this table an average gradient for the first 300 ft., for the second 300 ft., and for the last 200 ft., is readily obtained, and the average profile of the average run, from start to stop, can be determined at once, the intermediate distance being taken as level, as the effect of all intermediate gradients is comparatively small unless they are very heavy, in which case an allowance should be made in the final result. Of course, with sufficient experience, one may make an excellent determination of the average profile itself by unaided judgment, thus avoiding the necessity for such calculations as those indicated in Table XXV. Armstrong has given very convenient curves for cases of just this sort. His curves give the relation between the kilowatts input to the train on the one hand, and the stops per mile and the schedule speed of the train on the other. Armstrong's original curves, which are reproduced in Fig. 101, give the average kilowatts at the car for a car weighing 32 metric tons. The duration of stops appears to have been taken as 20 seconds. In Fig. 102, the same curves have been converted by the writers into terms of the watt-hours per ton-mile. This is an expression which does not vary greatly with the weight of the car or train.

Mr. F. W. Carter has kindly placed at our disposal the curve reproduced in Fig. 103. In this curve, Carter employs as ordinates the products of rated horse power per ton and $\sqrt{\text{stops per mile}}$, and as abscissæ the products of mean running speed in miles per hour (exclusive of stops) and $\sqrt{\text{stops per mile}}$. By this very ingenious way of plotting, Carter has been able, in a single curve, to obtain the

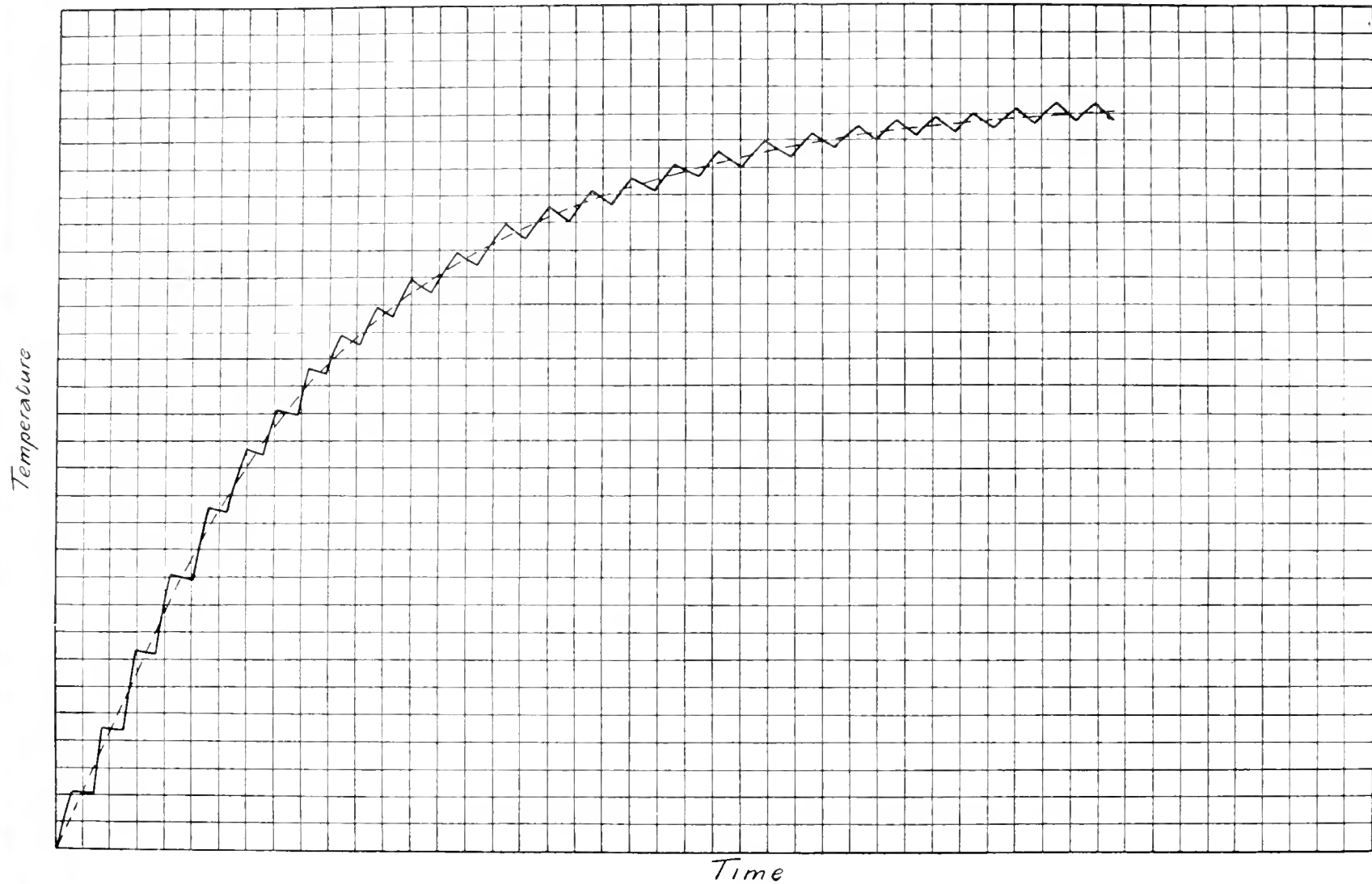

Fig. 100. CURVE SHOWING THE TEMPERATURE RISE OF A RAILWAY MOTOR WHEN RUNNING ON A SERVICE WITH LONG COASTS AND FREQUENT STOPS.



CHARACTERISTICS OF ELECTRIC RAILWAY MOTORS

equivalent of Armstrong's group of curves. The authors have made a comparison between Carter's curve and Armstrong's curves, and find that the latter curves can be represented with great accuracy by a single curve, in which the abscissa denote schedule speed \times stops per mile, the ordinates denoting horse power per ton \times (stops per mile)². We have worked out such a curve in Fig. 104 for a 30-ton train. Whereas Carter's curve (Fig. 103) gives the rated capacity (see p. 55 for definition of rated capacity of railway motors), the curve of Fig. 104 relates to input to train. In going from a 30-ton car to a 100-ton train, the watt-hours per ton-mile will remain practically

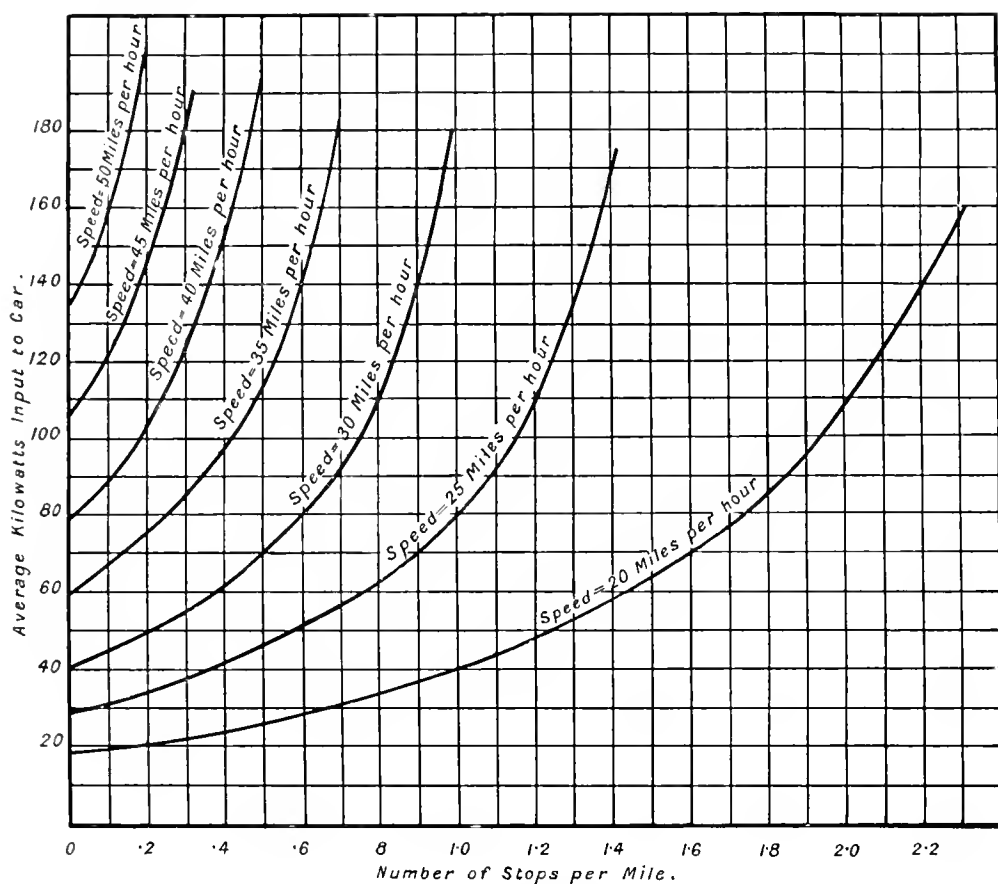

Fig. 101. THE EFFECT OF FREQUENT STOPS IN HIGH-SPEED RAILROADING. (A. H. Armstrong, *Street Railway Journal*, Vol. XXIII., p. 70, January 9th, 1904.)

Speed for above curves = Schedule Speed (i.e., including stops).

The diagram shows the energy consumption for a 32 (metric) ton car. Duration of stops = 20 seconds.

unchanged in all cases in which the air friction is small compared with the bearing friction, or in which the energy for overcoming the friction is small compared with the energy wasted in rheostats and braking. In other words, the lower the speed and the greater the number the stops per mile, the smaller will be the difference in the value of the watt-hours per ton-mile required for a 30-ton train and the value for a 100-ton train.

ELECTRIC RAILWAY ENGINEERING

While it has been repeatedly shown that at medium and high speeds long trains require much less energy per ton than is required for short trains, different investigators

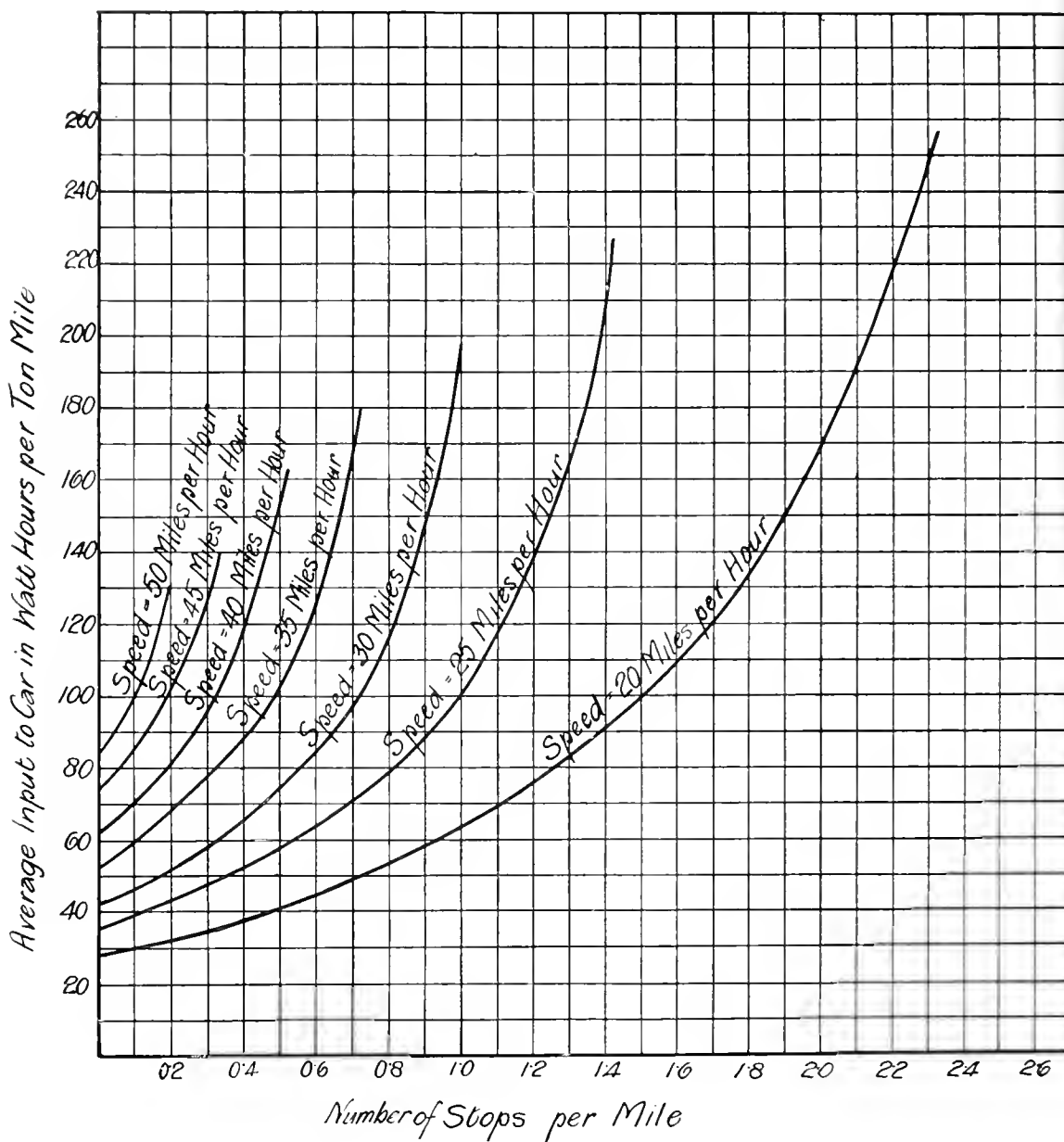

Fig. 102. ENERGY CONSUMPTION FOR A 32-TON CAR AT VARIOUS SCHEDULE SPEEDS.

Duration of stop = 20 seconds.

have arrived at widely-diverging values for the relative consumption of long and short trains. Aspinall's curves for the tractive force required at the axle for trains of various lengths have already been given in Fig. 2 on p. 6 of Chapter I. Armstrong, basing his

CHARACTERISTICS OF ELECTRIC RAILWAY MOTORS

conclusions on exhaustive tests by Davis, employs the curves reproduced in Fig. 105, in deducing the relative amounts of tractive force required for light and heavy trains. It is most difficult to reconcile these and other results, as well as to deduce a practical method of allowing for the variations in power required due to variations in the weight of the train, but these curves are useful as guides in such cases.

On p. 248 of *The Electric Journal* for May, 1906, Wynne has given some curves plotted from a formula by Blood, and showing the train resistance of single cars of different weights. These curves have been replotted employing metric tons, and are given in Fig. 106.

It is convenient for any particular case, to determine the required motor capacity by means of curves such as those just described, and then to increase this capacity by an amount commensurate with the conditions as to permanent way, gradients, curvature and rolling stock, for the particular case under consideration.

In comparing the above data with experimental results obtained on different lines, it must be kept in mind that an absolute agreement is quite out of the question. The rating of the motors actually installed on the trains depends also, as has been explained, on the

gradients and curvatures on the line. Even if these factors were eliminated, there would still be the individual judgment of the designer to be considered. Nevertheless, it is of interest to give the rated horse-power of the motor equipment chosen for a series of lines operated by continuous-current. These have been compiled in Table XXVI, from data for a considerable portion of which we are indebted to Mr. F. W. Carter.

Rated Power of Motors for Average Suburban Conditions

Acceleration = 1.5 Miles per Hour per Second

Braking = 1.75 " " " " " "

Coasting = 17.5% of Running Time (Excluding Stops)

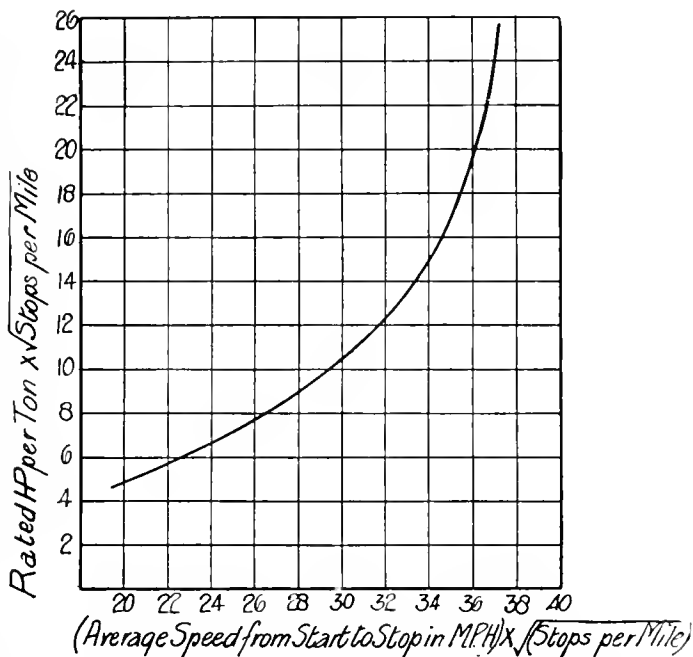

Fig. 103. CARTER'S CURVE OF RATED CAPACITY OF ELECTRICAL EQUIPMENT.

ELECTRIC RAILWAY ENGINEERING

TABLE XXVI.

Continuous Current Motor Equipments employed on a Number of Typical Railways.

Name of Line.	Schedule Speed in Miles per Hour (including Stops).	Number of Stops per Mile (the Stops are generally of from 10 to 20 Seconds' Duration. The Mean Value of 15 Seconds may be taken).	Weight of Car or Tram (including Equipment) in Metric Tons of 1,000 Kilogrammes (2,200 lbs.).	Rated Horse-power of Motors Installed on Car or Train, per Ton Weight of Tram. This Rating is the Standard Nominal Rating of 75 C. Rise after One Hour on Testing Stand.
Metropolitan District Underground Railway of London	15.7	2.1	175	6.8
Manhattan Elevated Railway	11.7	3.0	127	7.9
New York Rapid Transit Railway	16.2	2.6	162	7.4
Liverpool Overhead Railway	19	2.5	55	7.3
Central London Railway	14	2.1	120	4.2
Illinois Central Railway (Single Car)	17.8	1.8	29	8.7
North Eastern Railway	22	0.9	92	5.4
Railway A—Express Service	30.7	0.8	64	12.5
.. Local Service	19	2.6	64	12.5
.. Express Service	30.7	0.8	48	14.6
.. Local Service	19.1	2.6	48	14.6

Carter ("Technical Considerations in Electric Railway Engineering") states that on the 1-hour 75° Cent. basis of rating of railway motors, the weight of the electrical equipment comprising continuous current motors, rheostats and controllers, may be taken as 40 lbs. (18.2 kgs.) per nominal horse-power. He states that this is an average figure corresponding to suburban service, and must, of course, only be treated as a first approximation. The figure is furthermore based on motors of from 150 horse-power to 175 horse-power rated capacity. The equipment will be heavier with many motors, each of smaller capacity, and *vice versa*. He also points out in this connection, the importance of not overlooking the greater weight of motor trucks as compared with trailer trucks. On the basis of this figure of 40 lbs. per rated horse-power, Carter has deduced curves from which the writers have compiled the curves in Fig. 107. It is very evident that for each length of run there is a limiting average speed from start to stop which, even with high initial accelerating rates, cannot be obtained owing to the electrical equipment requiring its entire available capacity for self-propulsion, there being no residue for trucks, cabs, furnishings or for the load to be transported. This limiting speed is, of course, higher the less the frequency of stops.

The curves of total energy consumption at the contact shoe, per ton-mile, corresponding to the curves in Fig. 107, are given in Fig. 108 in terms of the schedule speed, for stops of 0, 10 and 20 seconds' duration. Allusion has already been made to the importance of a careful examination of any particular case, before making definite statements as regards schedule speeds for a given frequency of stops. Prior to a discussion of the subject of motor power required for given schedules and weight of electrical equipment, the matter could not be dealt with so fully as desirable. Now, however, we can revert to the subject and analyse it in the light of the more complete data set forth in the last section.

Schedule Speed and Number of Stops per Mile.

One of electricity's chief claims to superiority over steam as a motive power for railways is based upon the feasibility of maintaining a high schedule speed with frequent

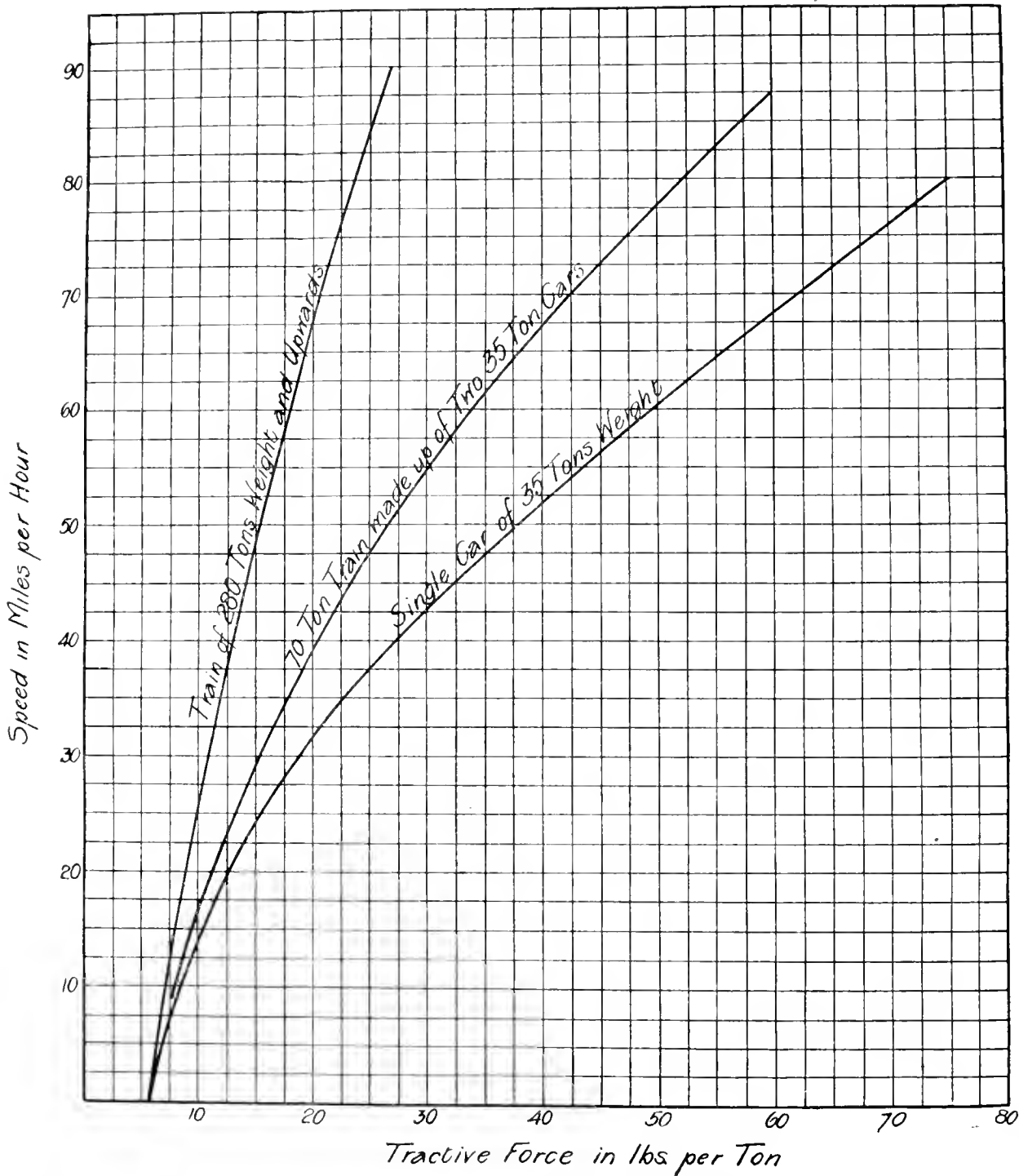

Fig. 105. ARMSTRONG'S CURVES FOR SHOWING THE VARIATIONS IN TRAIN RESISTANCE WITH SIZE AND SPEED OF TRAIN.

CHARACTERISTICS OF ELECTRIC RAILWAY MOTORS

stops. The high rate of acceleration obtainable by electric traction permits higher speeds, with a given number of stops per mile, than has been possible with steam motive power, but these possibilities have so encouraged promoters of electric traction

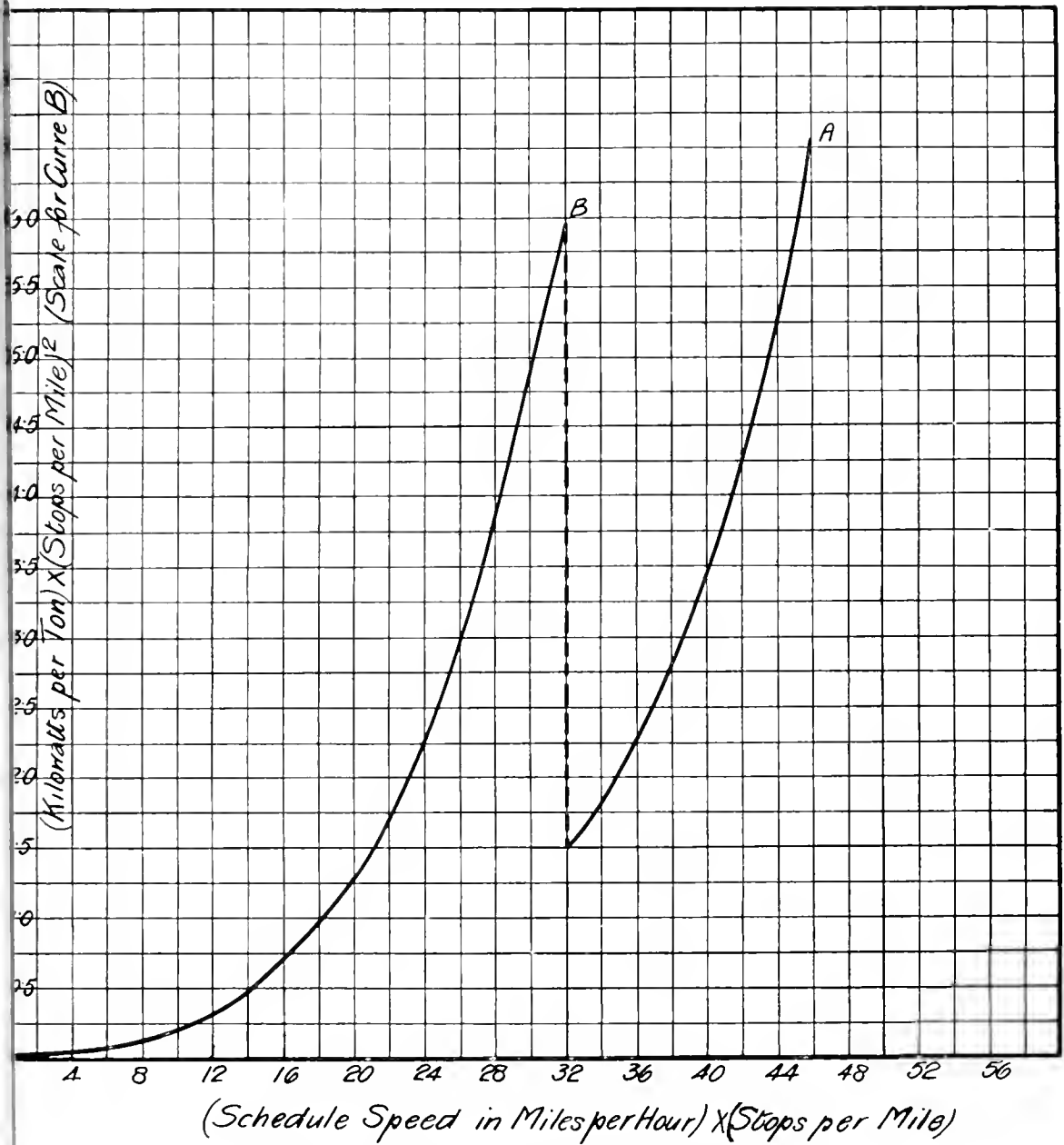

Fig. 104. CURVES FOR DERIVING THE KILOWATTS INPUT PER TON TO A 30-TON CAR FOR VARIOUS SCHEDULE SPEEDS AND VARIOUS STOPS PER MILE.

Duration of stop = 20 seconds.

enterprises that they sometimes lose sight of the fact that even electric traction has its limitations, and that high schedule speeds, which, with frequent stops, inevitably

ELECTRIC RAILWAY ENGINEERING

necessitate high accelerating rates, are only to be attained at very disproportionately increased cost. Limitations of space will only permit of the most cursory examination of the subject. By steam traction on railways, the rate of acceleration is generally considerably lower than 0.5 mile per hour per second, and one is able by electric motive power to obtain accelerating rates as high as 3 miles per hour per second: but it should not be concluded that such accelerating rates are desirable. They impose severe strains on the trucks and the permanent way: they involve the use of a total weight of electrical equipment, including motors, controllers, and regulating apparatus—such as rheostats or transformers, or potential regulators—which may exceed the weight of the remainder of the rolling stock, together with the passengers.

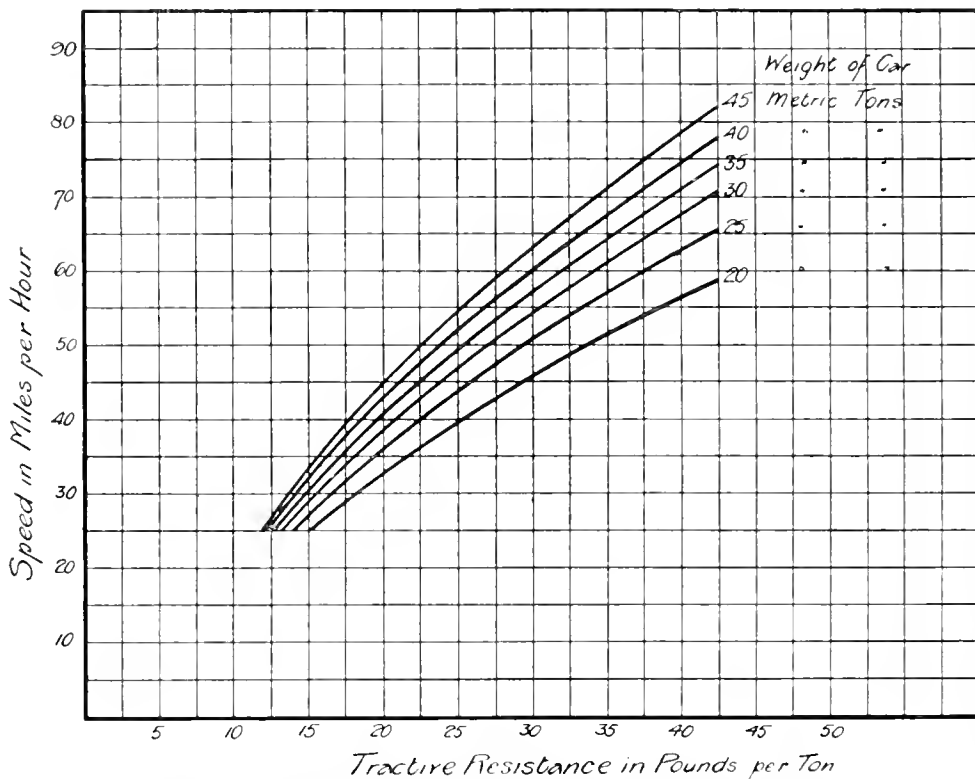

Fig. 106. CURVES OF TRACTIVE RESISTANCE FOR SINGLE CARS OF VARIOUS WEIGHTS ACCORDING TO WYNNE. (Blood's Formula.)

The passengers might be willing to sacrifice their personal comfort in the interests of shortening the time spent on the journey, but difficulty will attend adjusting fares at values commensurate with the expenses entailed in conforming to schedules requiring so high an accelerating rate. Of course, it must be admitted that conditions of traffic exist where the high train load factor justifies the heavy cost per train mile, and there is also the off-setting factor that the higher mileage per train per day reduces the number of trains required for a given frequency of service, and thus also the capital outlay for rolling stock. The greater wear and tear will, however, reduce this advantage considerably, in that a larger percentage of the trains will be undergoing repairs; in other words, a larger percentage of spare trains must be provided.

Leaving out the exceptional cases, it may be said that an average accelerating rate

CHARACTERISTICS OF ELECTRIC RAILWAY MOTORS

of 1.5 miles per hour per second is generally a fairly satisfactory value for passenger trains electrically operated, and is rarely or never exceeded in regular service. This is already over three times as great as the accelerating rates customary with steam passenger trains. The average rate of retardation during braking may also be taken at some 1.5 miles per hour per second. Let us permit the maximum speed to exceed the average speed from start to stop by $33\frac{1}{3}$ per cent., *i.e.*, with an average speed of 15 miles per hour from start to stop, let us permit a maximum speed of 20 miles per hour. Let the length of stop equal 15 seconds. With these assumptions, it may readily be found by graphical plotting that, with one stop per mile, the average obtainable speed between stops hardly exceeds 31 miles per hour, or a *schedule* speed (average speed, including stops) of 27 miles per hour. With two stops per mile (*i.e.*, one stop every 0.5 mile), the greatest obtainable schedule speed, on these same assumptions, will be but 19 miles per hour. On the contrary, should we run over sections of 2 miles' length between stops, we shall be able to obtain a schedule speed of 40 miles per hour. These results are brought together in Table XXVII:—

TABLE XXVII.

Schedule Speed with 15 Second Stops, for a mean Acceleration of 1.5 Miles per Hour per Second, and a mean Retardation of 1.5 Miles per Hour per Second, when the Maximum Speed does not exceed the average Speed from Start to Stop by more than $33\frac{1}{3}$ per Cent.¹

Number of Stops per Mile.	Greatest obtainable Schedule Speed.
2.0	19 miles per hour.
1.0	27 " "
0.5	40 " "

In a very interesting article on this subject (*Street Railway Journal*, Vol. XXIII., pp. 70, 71, January 9th, 1904) Armstrong has given data from which the average kilowatts input to the train, and the rated horse-power of the electric equipment of a 100-ton train, has been obtained for the three cases above considered. These values are set forth in Table XXVIII.

TABLE XXVIII.

Armstrong's Data for average Input to Train under various Conditions of Service (see Fig. 101).

Number of Stops per Mile.	Schedule Speed.	Average Kilowatt Input to 100-Ton Train.	Rated Horse-power of Equipment of 100-Ton Train.
2.0	19	140	630
1.0	27	230	1,000
0.5	40	400	1,800

¹ The mean speed from start to stop is termed the average speed, and the mean speed, including stops, is termed the schedule speed. Thus in the case with two stops per mile, a schedule speed of 19 miles per hour corresponds to an average speed of 22.6 miles per hour, and a maximum speed of 30 miles per hour, which is $33\frac{1}{3}$ per cent. higher than the average speed, and 58 per cent. higher than the schedule speed.

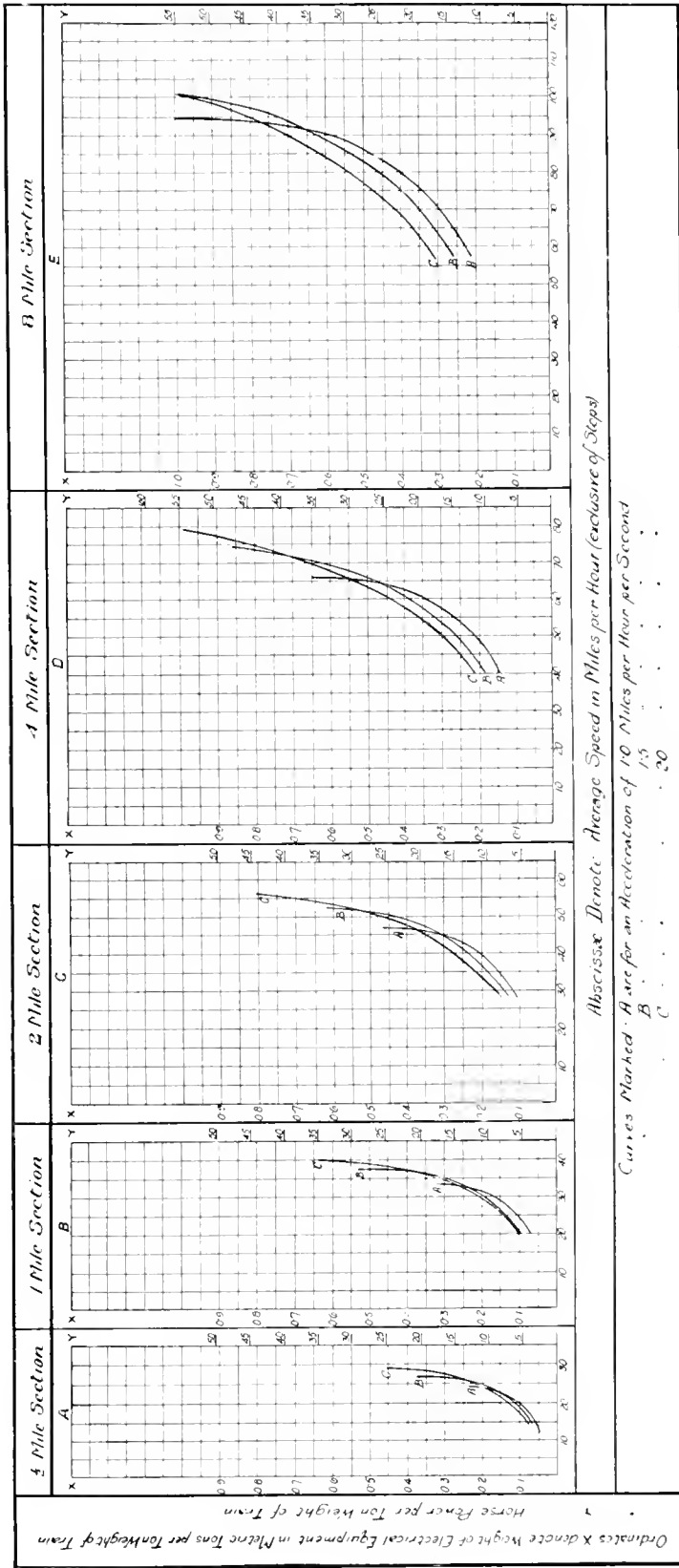

Fig. 107. CURVES COMPILED FROM CARTER'S DATA ON WEIGHTS OF CONTINUOUS-CURRENT EQUIPMENTS

ELECTRIC RAILWAY ENGINEERING

From data of the weight of complete electrical equipments, including continuous-current motors and accessories, the rough values set forth in Table XXIX. have been compiled:—

TABLE XXIX.

Representative Data of Trains for various Services.

Number of Stops per Mile.	Schedule Speed.	Train weighing 100 Tons complete, including Equipment and Passengers.		Seating Capacity.
		Weight, Electrical Equipment.	Weight remainder, including Passengers.	
		Tons.	Tons.	
2·0	19	30	70	220
1·0	27	40	60	180
0·5	40	65	35	100

From the values in Tables XXVIII. and XXIX., the figures shown in Table XXX. for the watt hours per seat-mile are readily deduced:—

TABLE XXX.

Watt-hours Input to Trains for various Services per Seat-mile.

Number of Stops per Mile.	Schedule Speed in Miles per Hour.	Watt-hours Input to Train per Seat-mile.
2·0	19	34
1·0	27	48
0·5	40	100

Now let us make a rough estimate of the schedule speed which would be practicable with two, one, and one-half stops per mile, if we allow 30 tons for the electrical equipment, *i.e.*, 30 per cent. of the total weight of the loaded train. There thus remains 70 tons for the balance of the equipment, which will provide for some 220 seats. Thirty tons of electrical equipment may be taken as corresponding to some 630 rated horse-power, and this will provide an average input to train of some 140 kilowatts. From Armstrong's curves in Fig. 101, and from the reasoning above employed, the following schedule speeds and energy consumption at train in watt-hours per seat-mile may be deduced, and are given in Table XXXI.

TABLE XXXI.

Watt-hours Input to Trains for various Services per Seat-mile.

Number of Stops per Mile.	Schedule Speed in Miles per Hour for 630 Rated Horse-power of Electrical Equipment.	Watt-hours Input to 100-Ton Train per Seat-mile.
2·0	19	34
1·0	24	27
0·5	30	21

CHARACTERISTICS OF ELECTRIC RAILWAY MOTORS

In Table XXXII. some further conclusions are derived from the preceding tables.

TABLE XXXII.

Dependence of Energy Consumption on Schedule Speed.

Number of Stops per Mile.	A. Highest practical Schedule Speed (with 15 Miles per Hour per Second Acceleration and Retardation, also Maximum Speed not over 1½ x Average Speed.	B. Schedule Speed corresponding to an Electrical Equipment constituting 30 per cent. of the total Weight of Train.	Per cent. by which Speed B is less than Speed A.	C Watt-hours per Seat-mile for A.	D. Watt-hours per Seat-mile for B.	Per cent. by which D is less than C.	Per cent. Decrease in Energy Consumption per Seat-mile, per cent. Decrease in Schedule Speed.
2.0	19 miles per hour.	19 miles per hour.	0 per cent.	34	34	0 per cent.	—
1.0	27	24	11 ..	48	27	44 ..	4.0 per cent.
0.5	40	30	25 ..	100	21	79 ..	3.2 ..

It is thus evident that for the first 10 per cent. to 25 per cent. or so, by which we reduce the schedule speed below the maximum practically obtainable, we shall reduce the energy consumption per seat-mile by from 3 per cent. to 4 per cent. for every 1 per cent. decrease in schedule speed; thus we can halve the watt-hours per seat-mile by a 15 per cent. decrease in the schedule speed below the maximum attainable under the specified conditions. Schedules requiring over 40 watt-hours input per seat-mile are for trains essentially extravagant. As an example of a much more moderate service, the Central London Railway may be mentioned. On this road, the weight of the electrical equipment is some 20 per cent. of the total train weight, and the energy consumption at the train is of the nature of 20 watt-hours per seat-mile, the average number of stops being 2.25 per mile, and the schedule speed being 14 miles per hour. But in the case of the Central London Railway, the inclines at the station approaches, contribute considerably in decreasing the energy input per train mile.

The estimations throughout this investigation are of the roughest nature, and are only intended to show the consequences of striving for high schedule speeds and frequent stops. Thus one might very properly question whether a train weighing 100 tons complete, and electrically equipped with power for so high schedule and maximum speeds as 40 and 53 miles per hour, respectively, with one stop per 2 miles, would or would not have the stated capacity of 100 seats. Standards for good practice in these directions are only slowly emerging. In many other respects the estimates are most crude, but it is thought that they may suffice to illustrate the point in question.

These considerations vitally affect the question of the relative advantages of the continuous-current and the single-phase systems. An equipment with alternating current single-phase commutator motors and the necessary controlling apparatus for running over not only alternating current, but also continuous current sections of line, may be taken as weighing at least some 40 per cent.¹ more than the corresponding equipment of standard continuous-current motors. For a given total weight of train, this will either necessitate reducing the seating capacity or reducing the schedule speed or the number of stops. If the total weight of train is increased so as to obtain the same seating capacity, then the watt-hours per train-mile will be increased, and this will require for a given schedule a greater rated horse-power per seat.

Let us confine our comparison to the same total weight of train—100 tons—already considered. The single-phase equipment will weigh, say $1.4 \times 30 = 42$ tons.

With the remaining 58 tons we can provide seating capacity for some 182

¹ This low figure of 40 per cent. greater weight is only taken from motives of conservatism.

ELECTRIC RAILWAY ENGINEERING

passengers. Neglecting the lower efficiency of the single-phase system, we obtain the figures given in Table XXXIII.

TABLE XXXIII.

Comparison of Input per Seat-mile, with Continuous-current and Single-phase Equipments.

Number of Stops per Mile.	Schedule Speed in Miles per Hour for 630 Rated Horse- power of Electrical Equipment.	Watt-hours Input to 100-Ton Train per Seat-mile.	
		Continuous-current Equipment.	Single-phase Equipment
2.0	19	34	41
1.0	24	27	33
0.5	30	21	25

As a matter of fact, the lower efficiency of the single-phase equipment will make these figures still more unfavourable to that system. Should we keep the seating capacity the same, we should be obliged to reduce the size of the equipment to not over 450 horse-power, and we should then have the schedule speeds and watt-hours per ton-mile for the two systems, as shown in Table XXXIV.

TABLE XXXIV.

Further Comparisons of Input with Continuous-current and Single-phase Equipments.

Number of Stops per Mile.	Schedule Speed in Miles per Hour.		Watt-hours Input to 100-ton Train per Seat-mile.	
	Continuous-current Equipment of 630 Horse-power, and weighing 30 Tons.	Single-phase Equipment of 450 Horse-power, and weighing 30 Tons	Continuous-current Equipment.	Single-phase Equipment
2.0	19	17	34	30
1.0	24	21	27	24
0.5	30	26	21	18

By interpolation from the two preceding tables, it is seen that for the same watt-hours per seat-mile for the two systems the schedule speeds would be as shown in Table XXXV.

TABLE XXXV.

Comparison of Schedule Speeds with Continuous-current and Single-phase Equipments.

Number of Stops per Mile.	Watt hours Input to 100-Ton Train per Seat-mile.	Schedule Speed in Miles per Hour.	
		Continuous-current Equipment.	Single-phase Equipment.
2.0	34	19	18
1.0	27	24	22
0.5	21	30	28

Furthermore, there is as yet no accessible comparative data to make it clear that the commutator of the single-phase motor will not deteriorate far more rapidly for a mean accelerating rate of 1.5 miles per hour per second than will the commutator of the continuous-current motor. Many engineers are quite satisfied that the former will

CHARACTERISTICS OF ELECTRIC RAILWAY MOTORS

deteriorate far more rapidly. It would be well, pending the further development of this class of motor, to specify that such motors shall be subjected on the testing stand to accelerating on an alternating current circuit from rest up to 20, 30, or 40 miles per hour, as the case may be, under such conditions of terminal voltage and load as would in actual practice give a constant accelerating rate of somewhat over 1.5 miles per hour per second with the car or train to be handled. If the motor is for a road operating with one stop per mile at a schedule speed of 20 miles per hour, this acceleration from rest should be repeated every 3 minutes for 15 hours per day for 10 days. If the commutators of 2 or 3 motors should be shown to sustain this test anywhere nearly as satisfactorily as the commutators of corresponding continuous-current motors, this commutation menace would be removed from the question, and the chief remaining disadvantages of the single-phase equipment would relate to its greater weight and lower efficiency. The matter has been alluded to, since attractive schedules for suburban trains are dependent upon the use of accelerating rates of from 1 to 2 miles per hour per second, and there appears to be room for doubt whether the single-phase commutator motor can equal the continuous-current motor with respect to good commutation under these conditions. Should this be so, then the use of the single-phase system will entail still further decrease in schedule speeds below those practicable with continuous-current equipments. Single-phase equipments will, of course, permit of much better schedule speeds for suburban service than are obtainable with steam locomotives, but it is probable that they will, to many of us, prove to be disappointingly inferior to continuous-current equipments.

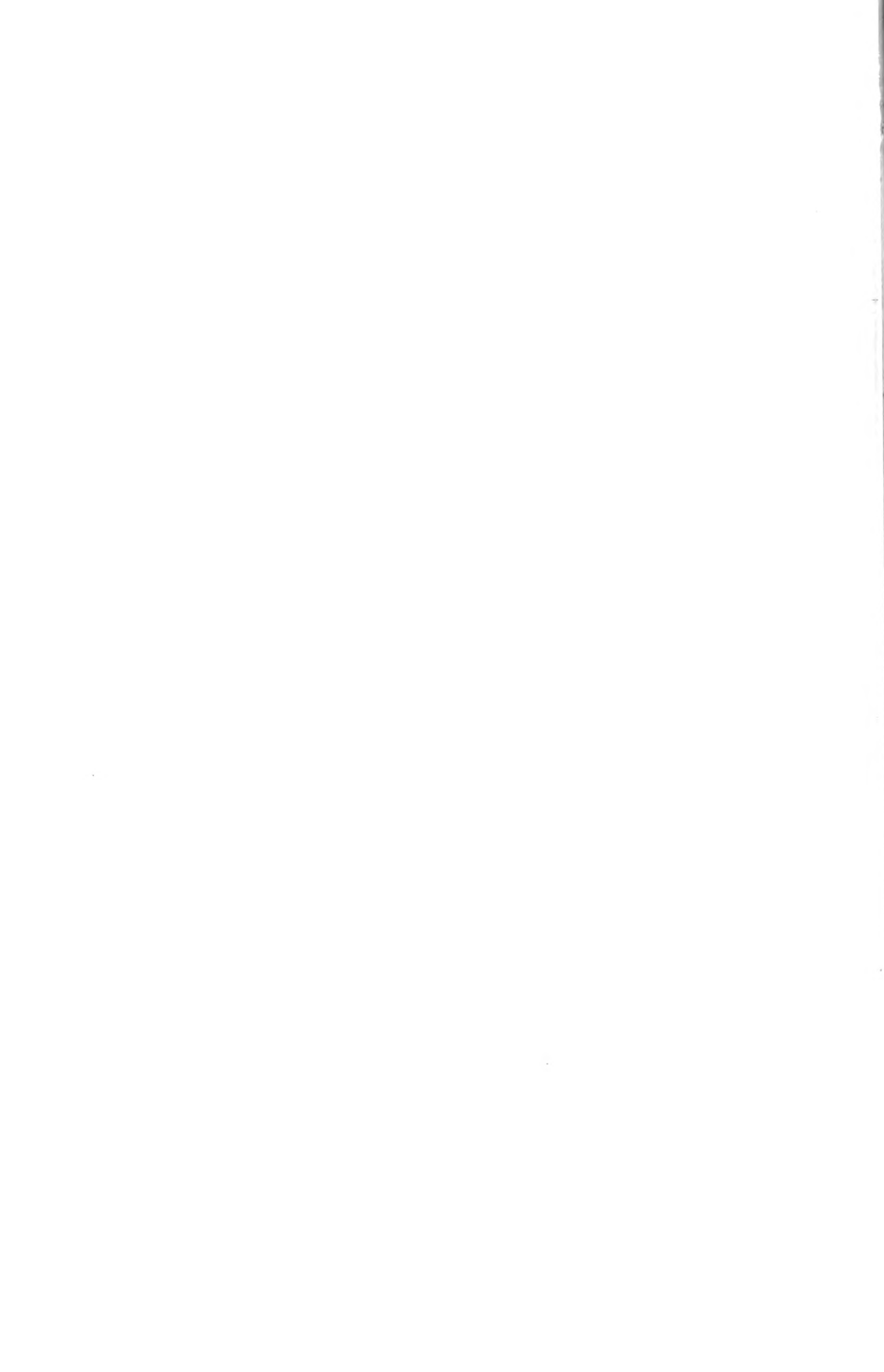

Part II

THE GENERATION AND TRANSMISSION OF
THE ELECTRICAL ENERGY

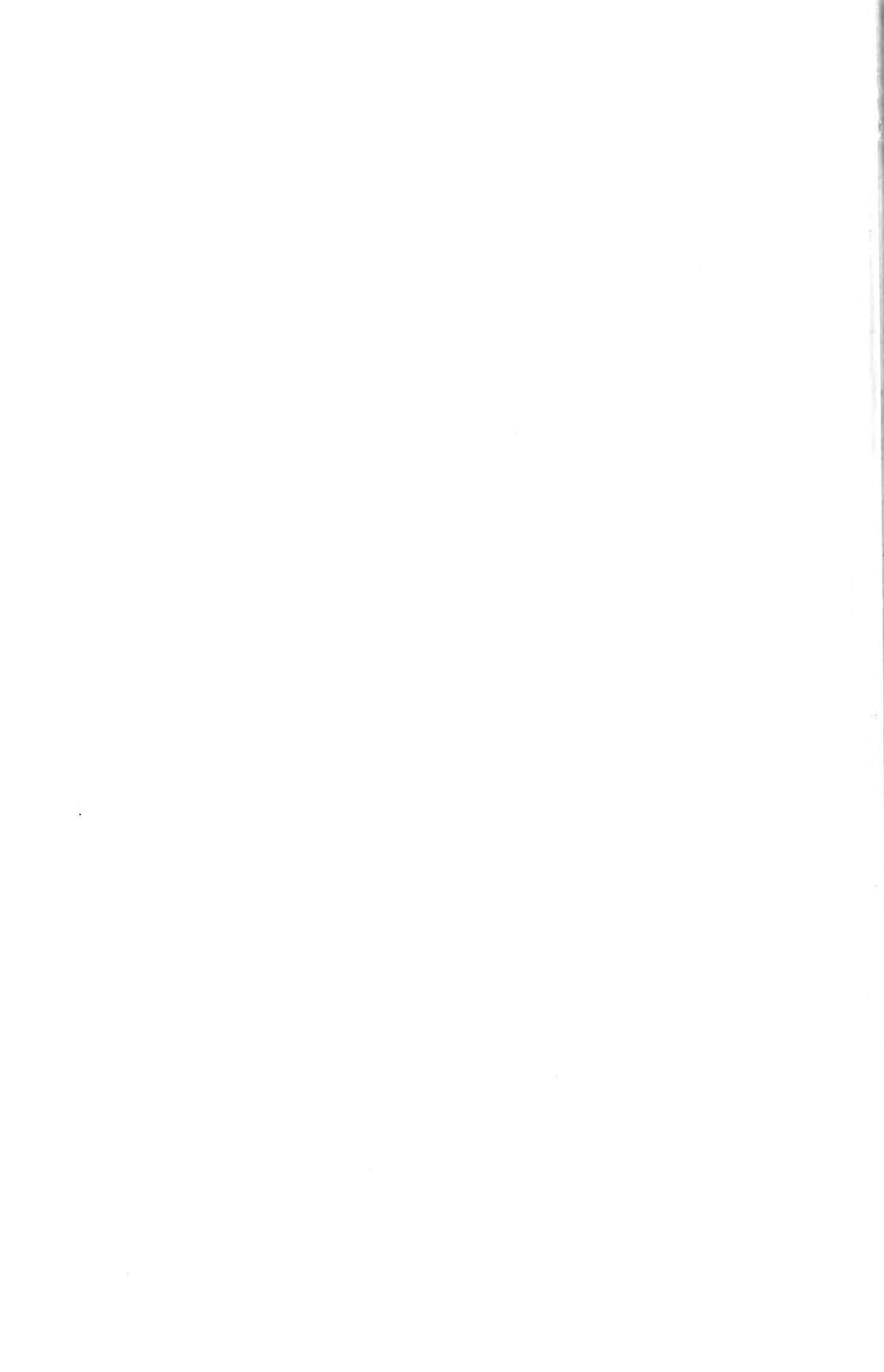

Chapter V

THE ELECTRICAL POWER GENERATING PLANT

THE amount of power to be provided by the generating station under service conditions has been dealt with in a previous chapter. For tramways working under normal conditions as to surface characteristics and rolling stock, the average power required at the generating station works out at about 7·8 kilowatts per car. The maximum fluctuation is from 50 per cent. to 100 per cent. in excess of this, according to the number of cars in service and the extent of the undertaking. It has been shown that in regard to the generating plant for a railway, a close investigation of the conditions of each undertaking is necessary, as the factors vary considerably. It has been shown how to take account of these variables, and how to derive, from the power curve of each section, a total output curve for the sub-stations and generating station, from which are obtained the average power, the magnitude, and frequency of the fluctuations. The present chapter will deal with the arrangement of the generating plant, and the design and characteristics of the component parts.

Taking as our starting point the load curve of the station, the next step is to decide upon the size of unit and the type of generating plant. The daily load curve should be consulted to determine the most suitable size of unit, which should be such as to give the highest load factor for the running plant consistent with steam economy, operating expenses, and capital cost. The range of load over which the generating set will maintain a suitable efficiency also enters into the question of its size, which should be increased until the extra steam consumption due to the poorer load factor balances the saving in capital cost and operating expenses. Under these conditions, the size of the generating set will increase with the size of the station up to the limit where mechanical unwieldiness interferes with operating economies. A limit of 5,000 kilowatts appears to be reached with reciprocating engines, but steam turbines appear to have a far higher limit than this, and for this reason, other conditions being favourable, it is probable that turbines will be favoured for future large installations.

Fig. 109 shows a daily load curve of the Central London Railway, and in the same diagram is drawn a line indicating the full rated output of the plant in service, the ratio of the two areas being the load factor *of the plant*. In this case six units of plant are installed, and the units in service during the particular day vary from one to five, and follow the load curve fairly closely. The momentary fluctuations in the load are not shown in this curve, and these, of course, have to be taken into account in adjusting the plant to the load. It will be seen how the peaks of the load are supplied from the overload capacity of the generators. In this connection the curve of the combined efficiency of the engine and generator is of importance, for by designing the

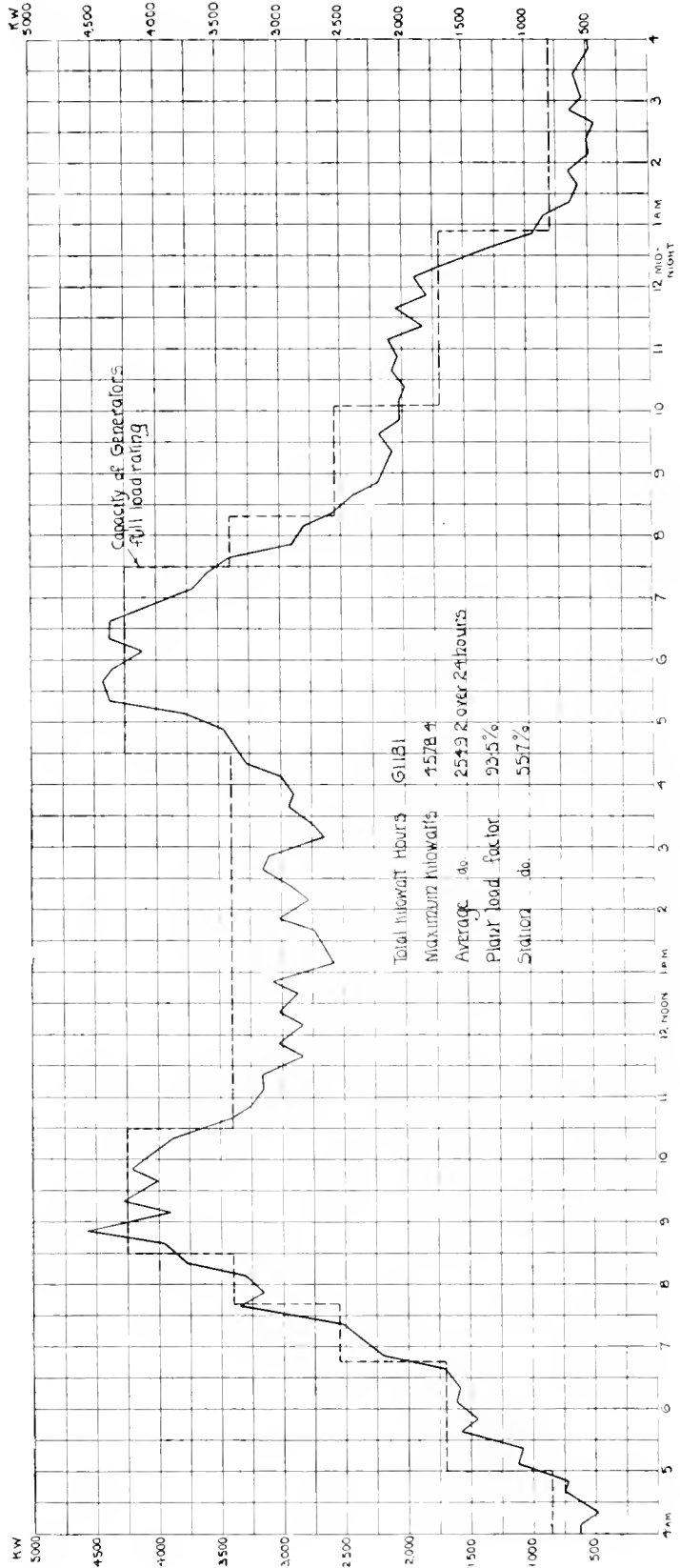

Fig. 109. CENTRAL LONDON RAILWAY: DAILY LOAD CURVE.

THE ELECTRICAL POWER GENERATING PLANT

engine and generator with a high level of efficiency over a long range a larger unit of plant might be used. This, however, tends to limit the overload margin of the set. Superheating of the steam has a tendency to preserve a high level of efficiency over a wide range, so that larger units may be used with good economy than otherwise would be advisable.

The amount of spare plant depends upon how often the plant is called upon to meet abnormal demands. Tramways, for instance, are liable to heavy loads on one or two days in the week, and to a still heavier one on special occasions, such as public holidays. To meet the former condition a single unit of plant may be provided as spare, while in the case of infrequent maxima it is sufficient to arrange that the whole of the plant shall be in service for the occasion, provided that the plant is of a reliable type, and the intervals sufficient to attend to repairs.

With regard to the type of generating plant, provided that the space at one's disposal and the characteristics of the load be taken into account, such matters as the choice of a plant resolve themselves into a question of capital cost against running cost. Broadly speaking, for a large installation with large units, a slow-speed engine or a steam turbine would be more suitable than a high-speed reciprocating engine. The former would be used if the facilities for condensing be limited, and the turbine if there is abundance of condensing water at a convenient level not involving much extra power in lifting. In the case of a small installation, where the size of units is under say 500 kilowatts, the high-speed reciprocating set would be found more suitable than a slow-speed set: and if the condensing facilities are limited, a steam turbine is out of the question as against a high-speed set, as the latter is not much more expensive, and is more economical under the circumstances.

In order to fulfil the conditions outlined, the engine and generator must be designed so as to respond readily to rapid fluctuations in the load. As regards the engine, the speed-regulating apparatus must be so designed that the variations of the speed from no load to full load, and also during each revolution, must be kept within the defined limits. It is usual to specify that the maximum variation in speed due to any variation in load between minimum and maximum shall not exceed $1\frac{1}{2}$ per cent. above or below the normal speed.

With regard to the first condition, the difference between the mean speed revolutions per minute at maximum and minimum load is dependent entirely upon the governor, but variations during any one revolution must be taken care of by the flywheel. These latter variations may be divided into two classes: first, those due to variations in the impelling force, the load remaining constant: secondly, those due to variations in the load without corresponding increase of the impelling force.

It has been found in practice for engines for electric traction purposes that the weight of flywheel necessary to maintain the speed between the fixed limits is much greater for the second than for the first of these conditions, and that if designed to fulfil the second, the flywheel will, in a well-balanced engine, be more than sufficient to deal with the variations in angular velocity due to variation in the impelling force.

The weight of the flywheel rim must be such that the energy given out in dropping through the allowable limit of speed variation during one revolution must be equal to the increase of load beyond that which can be dealt with by the energy expended by the steam available.

It has been found in practice that the maximum energy which the flywheel should be designed to supply under these conditions is about 80 per cent. of the maximum fluctuation of load to be dealt with.

ELECTRIC RAILWAY ENGINEERING

In designing the flywheel the effect of the revolving field or armature of the generator should be taken into consideration, and the weight of the wheel reduced accordingly.

As regards the variation of angular velocity during a revolution, the limits depend upon the design and type of generator and upon the periodicity. With alternators running in parallel, it is found, as a matter of experience, that in order to avoid fluctuations of voltage in the system, it is advisable to confine the angular displacement to within the limits of $2\frac{1}{2}$ electrical degrees above or below the mean.

The rapid alterations in the stresses and the weight of the flywheel necessitate a stiff shaft, but it is found advantageous to make the shaft considerably stiffer than these considerations alone would demand, as by this means undue stresses upon the reciprocating parts are avoided. These parts can then be designed strictly to fulfil their normal functions, and in consequence can be made much lighter than is otherwise the case.

As regards the generator, if of the continuous current type the conditions to be fulfilled are met by designing the armature coils for a sufficiently low inductance, a high magnetisation of the armature projections, and by over-compounding; by these means sparkless commutation may be obtained throughout a wide range of load. The generator is usually required to supply its full rated load continuously without a rise of more than 35 degrees Cent., and must, with fixed brush position for all loads, take 50 per cent. overload without sparking at the commutator. If the generator be of the alternating current type, in addition to the considerations mentioned as to variation in load, consideration must be given to the transmission, transforming, and converting system, in fact the whole system is closely interdependent. The design of the generator is affected by the resistance and inductance of the transmission system and by the nature and electrical properties of the sub-station plant, and the properties and characteristics of the whole must be kept in view in the design of each part.

The following is a specification of a type of engine and generator which has found extensive application in this country; the unit consists of a vertical cross compound engine coupled to a continuous current generator of 550 kilowatts rated output, and suitable for electric traction purposes.

Engine:—

Diameter of high-pressure cylinder	22 ins.
Diameter of low-pressure cylinder	44 „
Stroke	42 „
Revolutions per minute	90
Initial steam pressure	150 lbs.
Vacuum	26 ins.
Rated load, (I.H.P.) 800; cut-off, one-third stroke.	
Total weight of engine	120 tons.
Weight of wheel, 70,000 lbs.; diameter, 19 ft.; face, 16 ins.	
Diameter of bearing, 18 ins.; length, 36 ins.	
Diameter of shaft between bearings	19½ ins.
Diameter of crank-pin, 6 ins.; length, 6 ins.	
Diameter of cross-head pin, 6 ins.; length, 6 ins.	
Diameter of piston rod	4½ ins.
Diameter of steam inlet, 7 ins.; diameter of exhaust outlet, 16 ins.	
Guaranteed steam consumption	13 lbs. of dry saturated steam per I.H.P. hour.

THE ELECTRICAL POWER GENERATING PLANT

Generator :—

Rated output	550 kilowatts.
Pressure : no load, 500 volts; full load, 550 volts.	
Current	1,000 amperes.
Speed	90 revolutions per minute.

Armature winding :—

Number of circuits	10
Number of turns in series per circuit	90
Size of conductor	0·8 ins. × 0·08 ins.
Ampères per square inch of conductor	1,560
Number of slots	300
Number of conductors per slot	6
Diameter of armature at face	96 ins.
Length of core between heads	20·5 ins.
Dimensions of slots	2 ins. × 0·525 ins.

Field winding :—

Type	Compound.
Number of turns per shunt spool	1,154
Size of conductor in shunt winding	780 turns of No. 9 B. and S. 374 „ No. 10 „ „
Turns per series spool	8½
Size of conductor	·145 ins. × 6·5 ins.

Commutator :—

Diameter	86 ins.
Active length	8·875 ins.
Number of segments	900
Brushes	¾ in. × 1¼ ins., five per stud, ten studs.
Ampères per square inch of brush contact	42·8

Heating :—

Rise in temperature after eight hours' run at 550 volts and 1,000 amperes :—

Armature core surface	26 degs. Cent.
Commutator bars	22 „ „
Spool shunt	26 „ „

Insulation Test :

2,000 volts effective alternating pressure applied for one minute, between the electric circuits and framework.

Efficiency :—

One and a quarter load	94·4 per cent.
Full load	94·5 „
Three-quarter load	94·5 „
Half-load	94·0 „
Quarter-load	91·0 „
Weight, total	37 tons.

In the following specification are given particulars of a vertical 3-cylinder compound engine and 2,500-kilowatt three phase generator, also designed for traction purposes.

Engine :—

Diameter of high-pressure cylinder	42 ins.
Diameter of low-pressure cylinders	62 ins. and 62 ins.
Stroke	60 ins.
Speed	75 revolutions per minute.
Initial steam pressure	150 lbs.
Vacuum	25 ins.

ELECTRIC RAILWAY ENGINEERING

Engine—continued.

Rated load	4,000 I.H.P.
Cut-off	One-third stroke.
Total weight of engine	700 tons.
Flywheel: weight, 100 tons diameter 24 ft. × 26½ ins. face.	
Diameter of bearings first and second from high-pressure end, 22 ins. × 36 ins.; third and fourth, 24 ins. × 36 ins.; fifth and sixth, 32 ins. × 64 ins.; outer bearing, 30 ins. × 48 ins.	
Diameter of shaft at flywheel and armature spider	36 ins.
Diameter of crank-pins: high-pressure, 12 ins. × 12 ins.; first low-pressure, 16 ins. × 12 ins.; second low-pressure, 20 ins. × 12 ins.	
Diameter of cross-head pins	12 ins. × 12 ins.
Diameter of piston rods	8 ins.
Diameter of steam inlet	14 ins.
Diameter of exhaust outlets	24 ins. and 24 ins.

Generator :—

Rated output	2,500 kilowatts.
Number of phases	3
Connections	Y
Periodicity in cycles per second	25
Speed in revolutions per minute	75
Voltage between terminals	6,500
Voltage per phase	3,750
Amperes per phase	222
Number of poles	40

Armature Iron :—

External diameter of armature laminations	220 ins.
Diameter at the bottom of the slots	207½ ins.
Internal diameter of armature laminations	200 ins.
Gross length of core between flanges	22 ins.
Effective length of armature core	16.6 ins.
Number of slots	240
Number of slots per pole per phase	2
Nett weight of armature laminations after deducting slots	25,000 lbs.

Armature Copper :—

Number of conductors per slot (two in parallel)	18
Total number of conductors	4,320
Turns in series per phase	360
Apparent cross-section of two conductors in parallel	0.266 sq. ins.
Mean length of one turn	97 ins.
Resistance of armature winding per phase at 60 degs. Cent.	0.14 ohms.
Weight of armature copper	7,000 lbs.

Revolving Field :—

Radial depth of the air gap at the middle of the pole arc	1⅝ in.
Pole face diameter	199½ ins.
Total radial length of magnet core, including pole shoe	10½ ins.
Material of magnet core	Laminations
Material of yoke	Cast iron.
Polar pitch at air gap	15½ ins.
Length of pole arc	10 ins.
Weight of magnet cores (including pole shoes)	19,200 lbs.
Weight of yoke (exclusive of spider)	23,000 ..

THE ELECTRICAL POWER GENERATING PLANT

Magnet Copper:—

Number of turns per spool	42.5
Size of conductor	1½ ins. × 0.17 ins.
Resistance per spool at 60 degrees Cent.	0.0073 ohms.
Mean length of one field turn	64 ins.
Total weight of copper in forty spools	10,000 lbs.

Full Load Test:—

Indicated horse-power	3,630
Brake horse-power	3,480
Electrical horse-power	3,350
Steam per I.H.-P.	12.2 lbs.
Steam per B.H.-P.	12.7 ..
Steam per E.H.-P.	13.2 ..
Combined efficiency	92.3 per cent.
Mechanical efficiency, taking generator efficiency as 96 per cent.	96.2 ..
Permanent variation of speed from mean between no load and full load	1.5 per cent.

Efficiency of Generator

At full load	96 ..
At three-quarter load	95 ..
At half-load	93 ..

The station should if possible be arranged so that each generating set is piped direct from one boiler or battery of boilers, thus forming one complete unit. This enables the piping to be considerably simplified. Each unit can be operated independently: the steam header can be shut off completely, or can be used to enable any engine to be supplied from any boiler. This arrangement of steam piping gives good facilities for testing, and also provides numerous alternatives for working in the event of breakdown. The feed piping should be in duplicate, and all piping should have large easy bends where possible, and ample provision should be made for expansion.

The boiler plant should be arranged in units, each unit corresponding as nearly as possible to the requirements of one generating set. For small stations the Lancashire or tubular types of boiler still hold their own, but owing to the limitations of size by considerations of transport, they cannot be economically installed in any but the smallest power stations, as such small units in a large station would involve extra capital expenditure on buildings and piping, and an increase in the working cost.

For large installations, boilers of the water tube type are the rule, for the reason that they can be built in large units, 30,000 lbs. per hour at a pressure of 150 lbs. per square inch being in common use at the present time. By this means the piping can be simplified, and the first cost considerably reduced. Examples of this grouping and of the piping thereto will be seen on referring to the descriptive portions of this chapter.

The heating surface required for a steam boiler depends upon the initial and final temperatures of the furnace gases and the temperature of the feed water. The boiler is most efficient when the furnace temperature is as high, and the final temperature of the gases as low, as possible, and the heating surface will transmit from three to five British thermal units per hour per square foot per degree difference between the mean temperatures of gases and water, varying according to the condition, both internal and external, of the tubes.

The furnace temperature will depend upon the amount of surplus air necessary for combustion, which amount varies considerably with different grades of coal:

ELECTRIC RAILWAY ENGINEERING

50 per cent. surplus air is usual for furnaces burning 24 lbs. of small coal per square foot per hour, and the corresponding furnace temperature under these conditions will be about 2,400 degrees F., varying with the thermal value of the fuel burned.

The necessary draught for this rate of combustion is about $\frac{3}{4}$ inch of water, which may be produced either by a chimney or by artificial means.

The most satisfactory results are obtained when the velocity of the flue gases is between the limits of 12 to 15 feet per second. The amount of gases to be carried off being known, the necessary area of the chimney can be calculated from these figures.

The draught produced by a chimney depends upon its height and the temperature of the gases, and increases rapidly with this temperature up to about 300 degrees F., when the increased volume of the gases begins to counteract the effect of the increased draught until at about 500 degrees F. the weight of air delivered to the furnace is a maximum, and for a given height of chimney the weight of air delivered will decrease as this temperature is exceeded. The decrease, however, is very slight up to 800 degrees F., and as the requisite quantity of surplus air for combustion is correspondingly less as the rate of combustion is increased, the boiler may be forced by allowing the gases to escape at a high temperature, thus increasing the difference of temperature between the gases and the water, and increasing the rate of evaporation to meet special demands, at the expense of extra chimney losses.

With the steam pressure at 165 lbs. absolute, which is the usual pressure adopted in modern installations, it is found impracticable to reduce the temperature of the gases leaving the boiler to less than 500 degrees F., and it follows therefore that a thermal gain would result from the introduction of a feed heater or economiser, and the consequent reduction of the flue temperature from 500 degrees to the necessary chimney temperature of 300 degrees. It will be seen, too, that an additional saving of heat can be effected by installing forced or induced draught and reducing the temperature of the gases still lower by a further increase in the economiser surface, at the same time reducing the height of chimney to that necessary to dissipate the products of combustion.

These thermal gains, however, are not always commercial gains, and when the cost of economisers, flue space required, and the working cost of scraper gear and fans are taken into account, it will often be found better, from a commercial point of view, to allow the gases to escape at 500 degrees, especially when the feed-water has already been heated by exhaust steam. No definite rule can be laid down as to the advantages or otherwise of forced draught and economisers, owing to the widely varying conditions attaching to individual installations, but it may be taken as a general rule that economisers and forced draught should be installed only where the price of coal is very high and the feed temperature very low.

The advantages of superheating have been demonstrated and known for a considerable time, but many difficulties were encountered in adapting engines, pipes, and valves so as to withstand the high temperature. These difficulties have now been overcome so as to admit of superheating up to 150 degrees F. without any elaborate precautions, whilst superheating to the extent of 300 degrees F. and over is practised successfully with special precautions. This degree of superheat is apparently sufficient to ensure dry steam at the release point, and up to this point the saving in steam consumption appears to be about 10 per cent. for every 100 degrees of superheat, and a nett saving in heat energy of 6 per cent. for every 100 degrees. Above 300 degrees F. the law would probably be different, and it is questionable

THE ELECTRICAL POWER GENERATING PLANT

whether there would be any great advantage in working at a higher superheat. The figure quoted is for compound engines working at full load with cut-off about one-third of the stroke; with steam turbines the saving in steam consumption is about 9 per cent. for every 100 degrees of superheat. The question as to whether the superheater should be separately fired or fired by hot gases from the boiler furnaces depends upon the degree to which it is thought desirable to control the superheating. When the superheater is made an adjunct of the boiler, the heat of combustion is utilised to the utmost, and the means of control are sufficient for all practical purposes. With a steady load the superheating is fairly constant. With large boiler units, the tendency is to combine the boiler and superheater and to place the superheater so that the hot gases are passed through at an early stage in their course from the furnaces into the flue. This ensures sufficient and regular superheating, whereas if placed in the boiler uptake, the temperature may fall below the temperature necessary to impart the required degree of superheat and subject the superheater to a deposit of soot.

The amount of surface required for superheaters varies according to the condition of the surface, but 0.75 B.Th.U. per hour may be taken as the average transference for 1 square foot per degree difference of temperature between the mean steam temperature and the mean temperature of the hot gases. This rate of transference is lower than for boiler heating surface, due to the fact that the resistance to heat transference between two gases is higher than between gas and liquid. On the whole it would seem that the most economical arrangement of plant is to use superheaters as part of the boiler construction.

Considerable difference of opinion exists as to the relative advantages of mechanical stokers and hand firing; this is a matter depending a good deal upon the personality of the station superintendent. With the same plant one man will get better results from hand firing, and another from mechanical stokers.

Where large boiler units are to be used, mechanical stokers are almost a necessity, owing to the quantity of coal to be handled and the size of the grate. A boiler to evaporate 20,000 lbs. of steam per hour at a pressure of 165 lbs. absolute, would consume about 1 ton of coal per hour, and would require a grate area of 130 square feet to burn the cheaper classes of coal; a stoker would have considerable difficulty in reaching the far end of the furnace and in covering the surface evenly, and, moreover, the furnace door would need to be open a considerable proportion of the time and interfere seriously with the combustion.

When mechanical stokers are used, they should be selected with great care and should be adapted to burn the particular class and grade of coal available. The troubles which have been experienced with mechanical stokers have been due to a neglect of the limitations of the mechanical stoker in this respect.

We come now to the general principles affecting the condensing plant. The question of condensing or non-condensing does not arise in tramway or railway work, as the benefits to be derived from condensing are only doubtful when a plant is for occasional use, and not when the plant is run every day and for a considerable portion of each day. The type and arrangement of condensing plant, the highest vacuum which can be economically obtained, and the extent to which condensing should be carried in any plant, are points which merit some consideration.

The arrangement of the condensing plant may be either independent, that is, one condenser, air and circulating pump for each unit, or central, with a condensing plant dealing with the exhaust from the whole station. The central system

ELECTRIC RAILWAY ENGINEERING

has many advantages over the independent condensers: the plant is concentrated, and therefore requires less attention, and the pumping machinery has a better efficiency owing to the larger capacity.

The condensers for the central system should be in duplicate, each one of half the capacity of the station. This arrangement enables one condensing set to be shut down on light loads for overhaul or repair, and, in the event of a breakdown on one condenser, the whole station could be run on the other on a slightly impaired vacuum.

Independent condensers should only be installed with large units, and when the output of the station is so great as to render a central condensing system unwieldy.

The type of condenser depends entirely on the water supply. The types generally in use are the barometric, the jet and the surface condenser. If the station is situated near an abundant supply of cold water, the surface condenser gives the best results. The water of condensation, being free from impurities, can be pumped straight to the boilers without treatment, at a temperature within five degrees of that corresponding to the vacuum, while the low temperature of the cooling water also reduces the necessary cooling surface and thus enables the surface condenser to compare favourably with the barometric in point of cost.

Where water is scarce it becomes necessary to cool the circulating water by means of cooling towers, in which case the inlet temperature of cooling water is some 20 degrees F. higher than would be the case if the supply was drawn from a river, lake, or canal. The higher temperature of the inlet water necessitates a much larger quantity, and to reduce this quantity to a minimum and also to increase the efficiency of the cooling towers it is necessary that the water should leave the condenser as near the temperature of the steam as possible. The cooling water can be discharged from a barometric condenser within five degrees of the steam temperature at any vacuum or any inlet temperature, while, to obtain the same results from a surface condenser with high inlet temperature, the surface would have to be increased to an amount altogether prohibitive. Barometric condensers are, therefore, the most economical where cooling towers are used, as, the discharge from the condenser being as hot as possible, less water will be required, and the efficiency of the towers will be higher than with surface condensers.

In determining the cooling surface and the quantity of water required for a surface condensing plant for any given vacuum, the all-important factor is the temperature of the cooling water. The quantity of water required may be reduced by a proportionate increase in the cooling surface; the greater the cooling surface, the nearer the final temperature of the water will approach the temperature of the steam, and the reduced working expenses must be balanced against the extra first cost of the condenser to arrive at the most economical arrangement. In practice, however, it is seldom desirable to reduce the difference of temperature between the discharge water and steam to less than 15 degrees F., owing to the abnormal amount of cooling surface which would be necessary to obtain this result. The diagram shown on Fig. 110 has been prepared for the purpose of determining the quantity of surface and water necessary for any given vacuum and inlet temperature. The condenser should be designed so that the speed of water through the tube reaches or exceeds the critical speed at which the water is broken up, and the consequent transference of heat reaches a maximum. The speed should exceed 3 feet per second for tubes of 1 inch diameter.

The diagram is based on a heat transference of 200 B.T.U. per hour per square foot

THE ELECTRICAL POWER GENERATING PLANT

of surface per degree difference of temperature for all temperatures. This figure will vary with the state of the surfaces and according to the amount of air present, and, although it has been shown by tests that this figure can be exceeded, even doubled, the figure given may be taken as the average for condenser tubes under ordinary working conditions.

The vacua given in the diagram refer to the steam within the condenser. The presence of air in the condenser would cause the vacuum recorded on the gauge to be lower than that actually due to the steam, the difference depending on the effective volumetric capacity of the air-pump, so that about 97 per cent. of the vacuum given in the diagram would represent the gauge vacuum, the proportion varying according to the quantity of air present.

Of the many conditions which are inseparable from condensing propositions, the two known conditions are usually the vacuum required and the temperature of the cooling water.

The inlet water temperature is indicated on the left-hand side of the diagram by the diagonal lines ascending from left to right, and the difference of temperature between the outlet water and steam is shown by reverse diagonals. To ascertain from the diagram the quantity of water and surface required, follow the line corresponding to the known inlet temperature until the reverse diagonal corresponding to 15 degrees difference of temperature is reached. From this point ascend vertically to the curve corresponding to the vacuum, when the water required can be read to the left of the diagram. From the same point (*i.e.*, where the diagonals cross) proceed horizontally to the line corresponding to the vacuum at the right of the diagram, when the necessary surface will be found at the bottom. It will be seen that, should the amount of surface thus obtained be prohibitive, it can be reduced and the quantity of water increased, by varying the difference of temperature and proceeding as before.

For barometric condensers, the right-hand portion of the diagram is unnecessary, and, as the water can always be discharged at a temperature within 5 degrees of the steam, the necessary quantity may be found by following the line corresponding to the known inlet temperature up to the diagonal corresponding to 5 degrees difference, ascending vertically to the vacuum curve and reading to the left.

The difference of temperature between the steam and the outlet water in a barometric condenser, depends upon the extent of water surface exposed to the steam, and the finer the division of water and the more efficiently the steam is mixed with it, the smaller will be the difference of temperature and the less water will be required. In the most efficient counter-current condensers, this difference can be reduced to 5 degrees without increasing the size of the condensing chamber beyond the normal dimensions.

For circulating the water, there is little to choose between a reciprocating and a centrifugal pump. The former has the advantage of greater efficiency, and the quantity pumped can be varied to suit the load. The latter is cheaper in first cost, its maintenance is practically nil, and it requires the minimum of attention. In the case of a barometric condenser the quantity of water thrown by the centrifugal pump is to some extent dependent on the vacuum, which necessitates speed adjustment, either automatic or otherwise, to prevent the quantity of water pumped decreasing whenever the vacuum falls. In spite, however, of the relatively poor efficiency of the centrifugal pump and the disadvantages due to the lack of positive action, its use in connection with a barometric condenser is often desirable on account

ELECTRIC RAILWAY ENGINEERING

of its simplicity, cheapness, and low upkeep, and the special features of individual cases must decide the type of pump which should be installed.

The air should be extracted from the vacuum chamber by means of an air-pump, of which there are two types in general use, viz., the dry air-pump, which extracts the air only from the condenser, and the wet pump, which deals with the air and water in one operation. The dry air-pump is usually double-acting, and the friction losses are, therefore, only half of those which occur in a single-acting wet air-pump, but, owing to clearance spaces, the efficiency of the dry air-pump falls off rapidly as the vacuum is increased until a point is reached at which the entire stroke of the pump is devoted to compressing the air into the clearance space without raising its pressure sufficiently to discharge it against the atmosphere; on the return stroke the air re-expands into the cylinder, and no effective work is done by the pump. The air extracted from the condenser, being separate from the water of condensation, may be cooled on its way to the pump, thereby reducing the volume to be dealt with and consequently increasing the effective work performed by the dry air pump. The wet air-pump is usually single-acting, and for that reason is made with three cylinders to increase the volumetric capacity. The clearance spaces are water-sealed, and therefore the effective work of this pump only ceases when the air has been rarefied to such an extent that the leakages through joints, glands, etc., balance the volumetric capacity of the pump. The volumetric efficiency of a dry air-pump depends mainly on the proportion of clearance to length of stroke, and at low vacua the loss due to clearance is compensated for by its cylinders being double-acting, and its efficiency at a low vacuum is greater than that of a wet air-pump, but with a high vacuum the superior volumetric efficiency of the wet air-pump, due to the absence of clearance spaces, considerably more than compensates for the fact that its cylinders are single-acting. It may be assumed therefore that the higher the vacuum the greater the advantage of the wet over the dry air-pump, but the point at which this advantage begins depends on the extent of clearance in the dry air-pump.

If a wet pump is used in connection with a barometric condenser, cold water should be admitted to the suction in sufficient quantity to fill the clearance spaces, while in the case of a dry air-pump operating with a surface condenser an additional small pump is necessary to remove the water of condensation.

The air which has to be removed from the condenser is due largely to the air pumped into the boiler with the feed water, and to leakage in the engine stuffing boxes, and at the various joints in the piping and vessels in which the vacuum is maintained.

The presence of air tends to raise the pressure within the condenser, directly by reason of its own pressure being added to that of the steam and indirectly by retarding the transference of heat from the steam to the water. The reduction in the rate of heat transference due to the latter, necessitates a greater difference of temperature between the steam and water in order to condense the same amount of steam, and the temperature, and consequently the pressure, of the steam will therefore be raised until the difference of temperature is sufficient to transfer the necessary amount of heat against the resistance to heat transference due to accumulation of air.

The quantity of air thus admitted into the condensing system varies greatly with different installations, and is much larger with reciprocating engines than with turbines, and the volumetric capacity of the air-pump must depend upon the quantity of air to be dealt with and the extent to which it is expanded. As the degree of air expansion is increased, and the air pressure reduced, the gauge vacuum will approach nearer to the vacuum corresponding to the steam temperature, but as finality in this

THE ELECTRICAL POWER GENERATING PLANT

respect can never be reached, it becomes necessary to limit the vacuum efficiency, *i.e.*, the ratio of gauge vacuum to that corresponding to steam, to a figure which can be obtained with an air-pump of reasonable dimensions.

It will be seen that the quantity of air admitted must be assumed, but various trials of existing installations have shown that an effective air-pump displacement of 1 cubic ft. per pound of steam condensed will give a vacuum efficiency of 98 per cent. while maintaining a gauge vacuum of 28 ins. of mercury. The above figures indicate that the amount of air admitted to the condensing system under the conditions mentioned, is about 0.02 cubic ft. at atmospheric pressure for every pound of steam condensed, and if the air-pump displacement is assumed as above, the vacuum efficiency will vary with the extent of air leakage.

It would appear at first sight that the barometric condenser would require an air-pump with a larger capacity than would be necessary for a surface condenser, but experience has shown that the air brought into the condenser by the cooling water is carried away down the barometric pipe by the velocity of the water itself; in fact, with the requisite supply of cooling water, a vacuum of 28 ins. can be maintained in a barometric condenser working without an air-pump. The air-pump proposition is therefore the same for both surface and barometric condensers.

Given equal conditions, the economical vacuum is much higher for a steam turbine than for a reciprocating engine, the economy in steam due to increased vacuum for the former being about three times as great as the steam economy of a modern reciprocating engine. This is partly accounted for by the leakage past the piston and valves of a reciprocating engine, and also cylinder condensation, increasing with the vacuum, while a steam turbine has no source of leakage which cannot be water-sealed.

With large units, the steam consumption is reduced by about 1 lb. per kilowatt-hour for turbines and by about 0.35 lbs. per k.w.h. for modern compound reciprocating engines for every inch increase in vacuum between 24 in. and 29 in.

The economical vacuum is reached when the extra saving in steam due to any extra increase in vacuum is balanced by the cost of producing this increase, and as the quantity of water required for this purpose increases greatly with the inlet temperature, it follows that the chief factor in determining the economical vacuum is generally the temperature of the circulating water. There are so many conditions which indirectly bear on this question that it is impossible to lay down any definite rule applying to all cases, and in determining the most suitable vacuum the special features relating to each installation must be considered.

The extent to which condensing should be carried is also affected by the desirability of not unduly reducing the temperature of the hot well, which in a properly proportioned condenser with an air-pump of ample displacement, will not differ materially from the temperature corresponding to the vacuum, and a portion of the plant should be run non-condensing in order to provide sufficient exhaust steam to raise the temperature of the feed water from the hot-well temperature to 212 degrees F., that is to say, to the highest possible temperature at atmospheric pressure. Where the plant consists of a few large units, it is impracticable to apply this principle to the main plant, as the exhaust from one unit would be far in excess of the quantity necessary for feed water heating, and the loss of power due to atmospheric working would outweigh the benefits derived from raising the feed water temperature. There remains, however, the auxiliary plant, consisting of feed-pumps, air and circulating pumps, and, in the case of alternating current stations, exciter engines, and as

ELECTRIC RAILWAY ENGINEERING

many of these auxiliaries should be steam-driven as will provide, with a margin for contingencies, sufficient exhaust steam to raise the temperature of the condensed water from the main plant, together with the make-up water, to 212 degrees F. The proportion of plant which should be used for this purpose will, of course, vary with the relative steam consumption of the main and auxiliary plants, but speaking generally, 1 i.h.-p. of auxiliary engines will be required to deal with the condensed water of 16 i.h.-p. of main plant when the vacuum is 26 ins., and for 14.5 i.h.-p. with the vacuum at 28 ins.

At 212 degrees F. any scale-forming substance in the make-up water is deposited, hence the heater should take the form of a heater detartariser, in which the deposits can be conveniently dealt with, and in which the steam mingles with the water, and so ensures the maximum transference of heat. In view of the advantages derived by the scale being formed outside instead of inside the boiler, it is important that the feed water should be kept up to the atmospheric boiling point, and if, as is often the case, the exhaust from the whole of the auxiliary plant is insufficient for this purpose, live steam should be introduced into the heater in sufficient quantity to impart the necessary heat to the water.

There are many varieties of apparatus in use for cooling the circulating water, all of which depend for their action upon the contact of water and air in motion. The apparatus which is mostly favoured, and which is generally found to be the most convenient and suitable for ordinary installations, is the cooling tower, in which the water is pumped to a height of about 30 or 40 ft., and allowed to fall in drops, or in a film, over suitably disposed surfaces, the heat being extracted by the ascending current of air, the volume of which is dependent on the area of, and draught produced by, a chimney about 60 ft. in height.

The temperature and humidity of the air entering and leaving the tower, and the temperature of the inlet and outlet water, are the conditions which determine the necessary water surface and the height of chimney, and as the former varies greatly in different seasons and localities, the cooling plant should be designed on a very liberal basis, and to meet the worst possible conditions.

Heat is transferred from the water to the air by radiation, which raises the temperature of the air, and by evaporation, the latent heat for which is extracted from the remaining water. The transference due to radiation may be taken as 0.3 B.Th.U. per hour per square foot of water surface per degree F. of mean difference of temperature between water and air, at a relative air and water velocity of 6 ft. per second, and this transference varies as the square root of the velocity. The heat given up by the water for evaporation, however, varies with the humidity and temperature of the air entering and leaving the cooling tower. The air on leaving the water is usually saturated to about 90 per cent. of the maximum saturation due to its temperature, and as the water necessary for completely saturating the air increases greatly as the temperature rises, it follows that the higher the outlet temperature of the air the greater the amount of heat transferred by evaporation for a given inlet temperature and humidity. On the other hand, the higher the outlet temperature of the air, the greater will be the amount of water surface necessary for radiating the balance of the heat to be transferred. A difference of temperature of 10 to 20 degrees between the outgoing air and the incoming water will be found to give an amount of surface which can be contained in a tower of reasonable dimensions. The outlet temperature of the air may be fixed by assuming a difference as above, and thus the amount of heat extracted from the water for 90 per cent. saturation of air at this

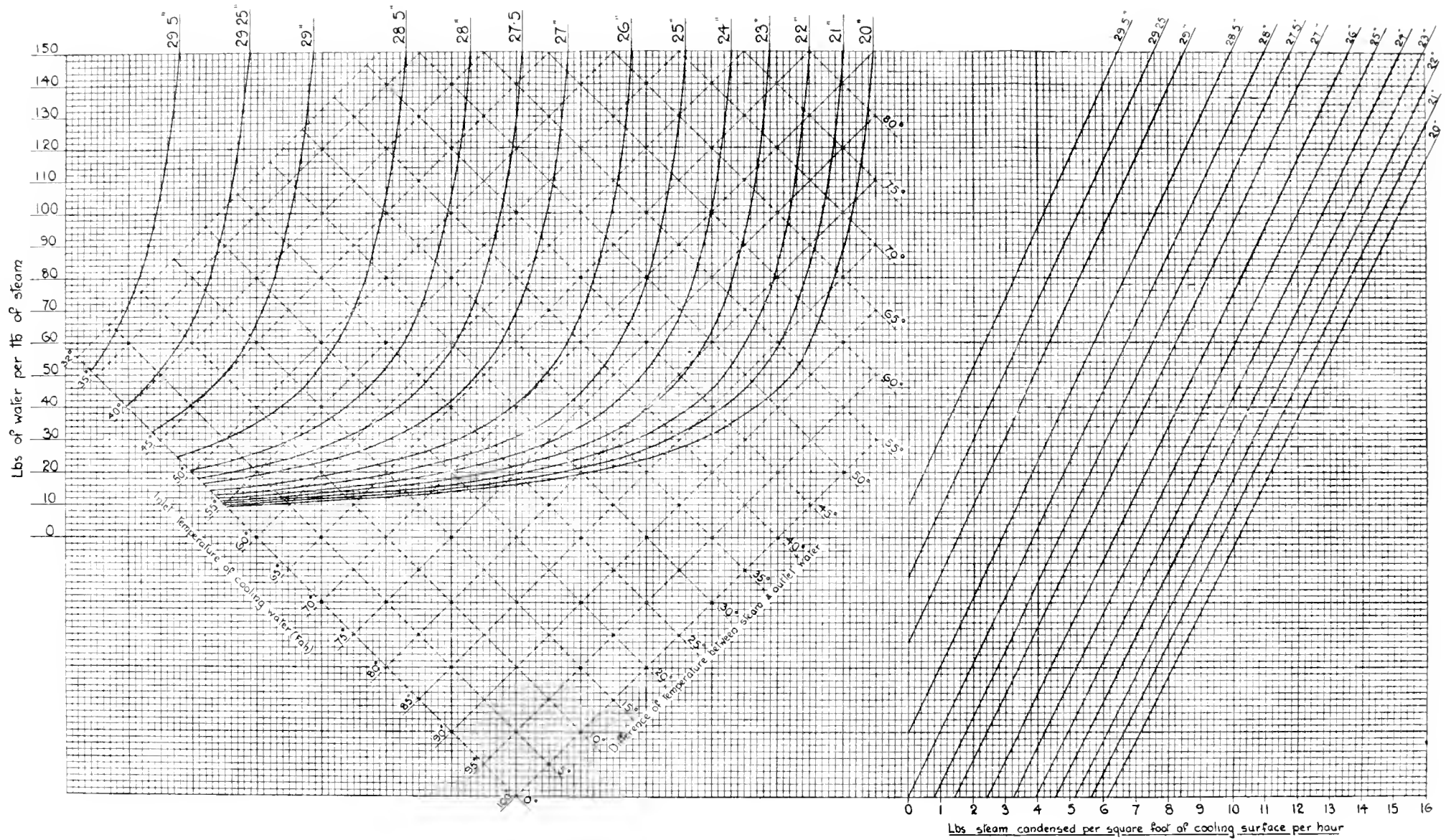

The vacua given above are based on barometer of 29.92 inches of mercury, and are calculated for steam only; allowance should be made for the presence of air.

The cooling surface is based on a heat transference of 200 British Thermal Units per hour per square foot, per degree difference of temperature for all temperatures this being the average for condenser tubes under ordinary working conditions; for other rates of transference the steam per square foot must be varied directly.

Fig. 110. DIAGRAM FOR ESTIMATING CONDENSER CAPACITIES.

THE ELECTRICAL POWER GENERATING PLANT

temperature may be ascertained, so that if this amount is added to the heat taken to raise the air temperature, and the sum divided into the total heat to be extracted, the total amount of air required is the result. Accepting 60 ft. as the height of chimney, and the density and volume of air required being known, the velocity of air and consequent area of chimney may be found by the application of well-known rules, and the airways through the water surfaces should total rather more than the area of the chimney in order to avoid excessive resistance. The necessary surface can now be ascertained by applying the figure given above for transference of heat by radiation.

It may happen that, owing to the low inlet temperature of the water to be cooled and the high prevailing atmospheric temperature and humidity, the necessary amount of water surface will be so great that the first cost and ground area required will render the size of tower thus obtained prohibitive. It will be seen that the cooling surface may be reduced by increasing the difference of temperature between the outlet air and inlet water, but as this means a greater volume of air, and as the lower air temperature will reduce the draught produced by the chimney, it follows that the chimney height must be greatly increased, or that the air must be forced through the tower by fans. It will be found impracticable to produce the desired result by increasing the height of chimney, and as the power consumed by fans is seldom justified by results, the vacuum should be reduced, and the consequent temperature of the water and the efficiency of the tower increased until the necessary size of tower is reduced to the proportions at which the first cost is justified by the saving in coal due to the resulting vacuum.

If the water passes in a film over plates or pipes, the amount of exposed water surface is, of course, equal to the total area over which it travels, but where the water is allowed to fall in drops, the tower should be designed so as to ensure that the water is divided up as finely as possible, and for proportioning the surface under such conditions it may be assumed that 300 gallons of water will expose 100 sq. ft. of surface when falling through a height of 32 ft. in the finest possible state of division.

Having outlined the principles affecting the generating station equipment, the design of the individual apparatus, and their combination, these principles are best illustrated by reference to plants in actual operation, and we select for this purpose the following stations as being representative of large tramway and railway generating plants which have proved very successful from every point of view. The conditions to be met in each case are sufficiently divergent to illustrate the application of the principles set forth in the early part of this chapter. The plants we select for our purpose are those of the Central London Railway Co., the Glasgow Corporation tramways, the Bristol tramways, and the Dublin United tramways.

A special feature of the Central London Railway is the use of cooling towers for dealing with the circulating water for condensing. In the case of the Bristol tramways plant, owing to the limited space, the plant is arranged in storeys. In the case of the Glasgow Corporation tramways and the Dublin United tramways the conditions to be met are not exceptional, and the installations may be taken as representative of their class.

Taking first the Central London Railway, the power-house (Figs. 111 and 112) is situated at the Shepherd's Bush terminus of the Central London Railway. The building consists of a framing of steel work which supports the crane girders, coal

ELECTRIC RAILWAY ENGINEERING

bunkers, and roof trusses, the framework being filled in with brick walls 1 ft. 10½ ins. thick. The floors of both engine and boiler rooms are constructed of steel joists filled

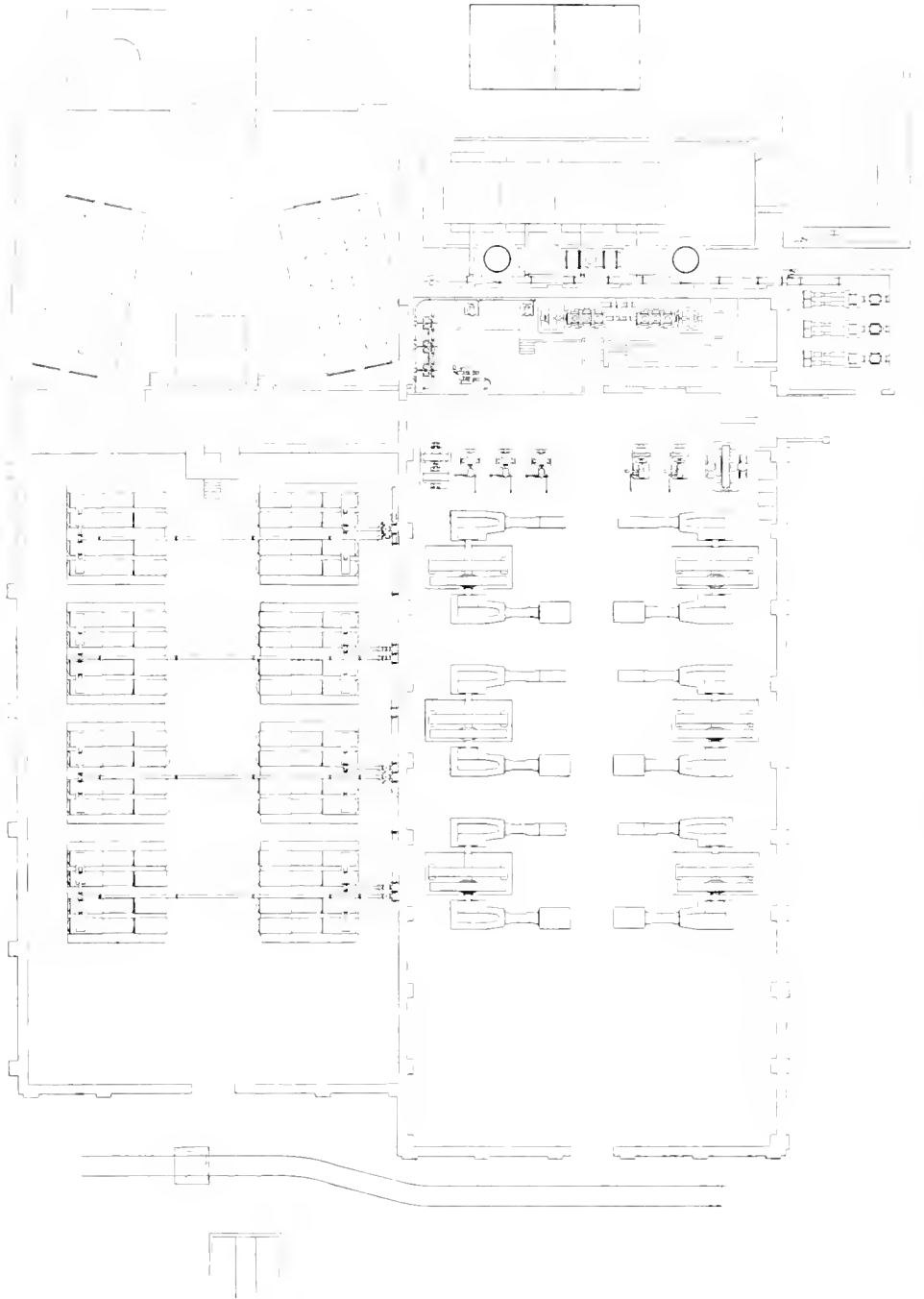

Fig. 111. CENTRAL LONDON RAILWAY: PLAN OF POWER STATION.

in with concrete, and the roofs consist of boarding supported on wood purlins, the whole being covered with slates.

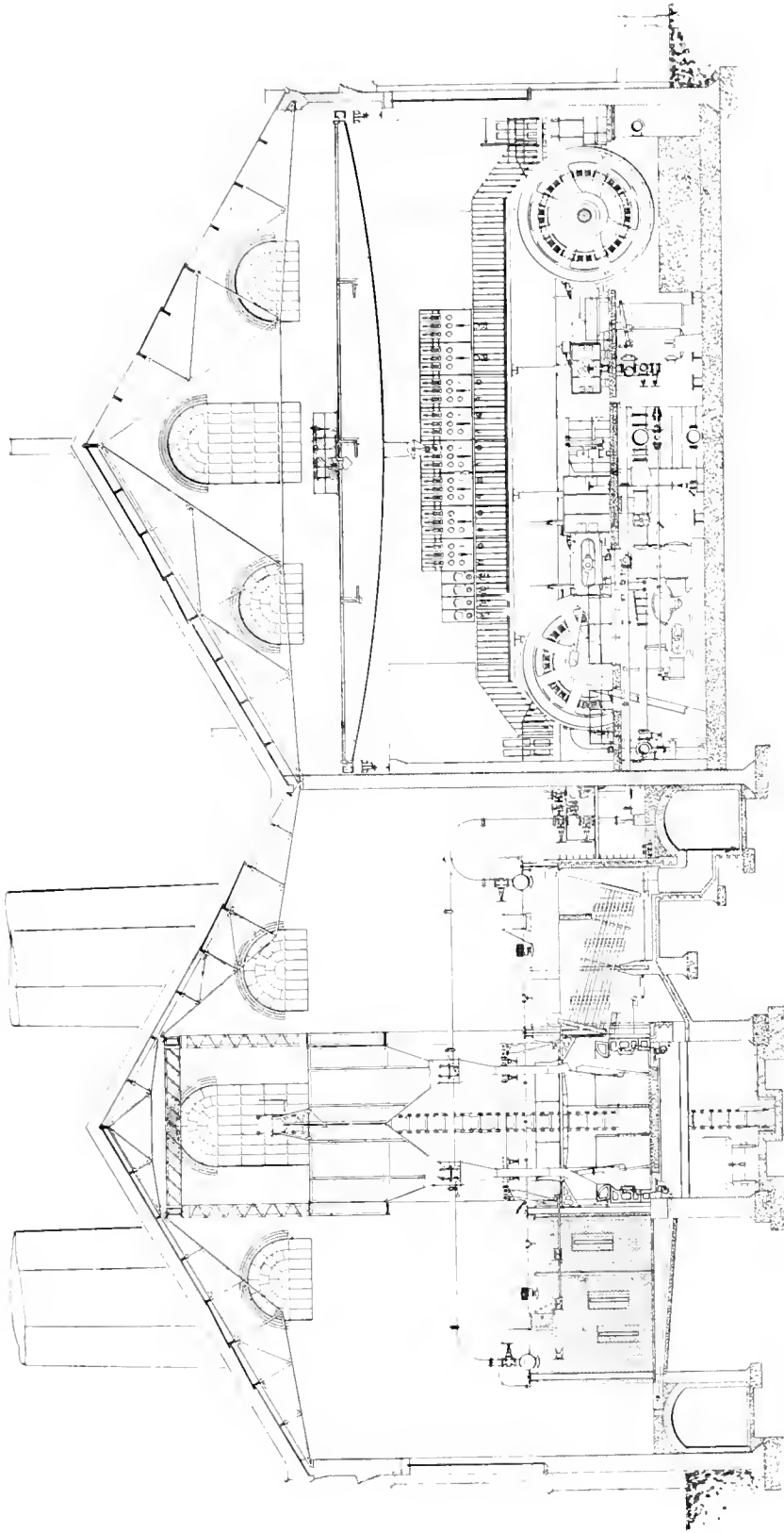

Fig. 112. CENTRAL LONDON RAILWAY: CROSS-SECTION OF POWER STATION.

ELECTRIC RAILWAY ENGINEERING

Coal is brought on to the site by a siding from the Great Western and London and North-Western Railways, and is dumped from the trucks into a hopper situated at the end of the boiler room. The coal is fed from this hopper into a gravity bucket conveyer, which passes along the boiler room basement, up the end walls, and over the boiler room coal bunkers, from which the coal is supplied to the automatic stokers as required, by means of spouts.

The boilers are arranged in eight batteries of two boilers each, four batteries being on each side of the boiler room, and the firing floor in the centre.

The steam piping is arranged so that each battery of two boilers can supply one engine direct through an 8-in. pipe, and a branch is taken from each of these pipes into a 12-in. header, so that, if necessary, any engine may be supplied from any battery.

Two lines of standard-gauge railway track are laid in the boiler room basement, and the ashes are run direct into trucks, which, after passing through a tunnel under the outside hopper, are hauled up an incline of about 1 in 24 to the general yard level.

The main flues are situated at the back of the boilers in the basement, and a fuel economiser is inserted in each flue, a by-pass being provided so that either flue may be turned through either economiser into either chimney. There are two brick chimneys, octagonal in shape, situated about 90 ft. from the end of the boiler room, and 44 ft. apart, and the firebrick lining in each is carried to a height of 40 ft. The economiser scraper gear and motors for driving same are situated in a chamber above the economisers and flues, between the boiler room and the chimneys, and at the level of the boiler room firing floor.

The main generating sets are arranged three on each side of the engine room, leaving a clear floor space of 10 ft. in the centre of the engine room. The exhaust from the main engines is taken through 18-in. branches into a main 42-in. pipe, which passes along the centre of the engine room basement to the end of the engine room. It is then taken upwards to a height of 16 ft. above the engine room floor level, where, by means of a 42-in. tee piece, the exhaust steam is turned either right or left into duplicate oil separators and condensers. A 24-in. pipe provided with an automatic relief valve is taken from the top of the tee piece and continued up the engine room end wall above the roof to the atmosphere.

The circulating water is drawn from three tanks, 23 ft. in diameter and 20 ft. deep, by three triple expansion pumps, the water being pumped into the bottom of either or both condensers. After passing twice through the condenser the water passes to the cooling towers and finally reaches the suction tanks.

The Edwards air-pumps are situated at the end of the engine room, and discharge the water of condensation into a tank of 1,580 gallons capacity, from which the boiler feed-pumps draw their supply through a Venturi water meter. The make-up feed water is drawn from the circulating water on the discharge side of the condensers, and the make-up for the circulating water is discharged into the cooling tower tank from an artesian well, the air compressor for this purpose being situated in the basement of the engine room.

The oil is drawn from the separators by means of small oil pumps fixed to the end of the air-pumps and operated from the end of the air-pump crank shaft.

Table XXXV. contains a schedule of the type and capacity of the plant installed.

THE ELECTRICAL POWER GENERATING PLANT

TABLE XXXVA.

Schedule of Type and Capacity of Plant Installed at the Central London Railway Generating Station.

Item.	Number	Type.	Size and Rating.	Remarks.
Main engines	6	Horizontal cross compound condensing, Corliss gear, 94 revolutions per minute	Cylinders 23 ins. and 16 ins. in diameter × 48 ins. stroke, 1,250 I.H.-P.	Steam consumption on full load, 14·3 lbs. of saturated steam, 150 lbs. pressure, and 26 ins. vacuum.
Main generators	6	Three - phase revolving field type, 5,000 volts, 25 cycles per second	Full load, 850 kilowatts	Efficiency at full load 95 per cent., at half-load 91 per cent.
Exciter engines	3	Vertical tandem compound, 400 revolutions per minute	Cylinders 9½ ins. × 15 ins. diameter × 6 ins. stroke, 75 I.H.-P.	
Exciter generators	3	125-volt	Full load, 50 kilowatts	
Exciter motor	1	Induction type, 5,000 volts, 290 revolutions per minute	Full load, 200 H.-P.	
Exciter generator	1	125-volt	Full load, 120 kilowatts	
Lighting engines	2	Vertical compound, 400 revolutions per minute	Cylinders 8 ins. and 14 ins. diameter × 7 ins. stroke, 75 I.H.-P.	
Lighting generators	2	Continuous current, 500 volts	Full load, 300 kilowatts	
Transformers	3	Three - phase, air-cooled, 5,000 volts to 300 volts	Full load, 300 kilowatts	
Rotary converter	1	Three - phase, 300 volts A.C. to 500 volts C.C.	Full load, 900 kilowatts	
Condensers	2	Vertical, open top surface condensers	Cooling surface, 9,000 sq. ft.; capacity, 80,000 lbs. of steam per hour	
Air-pumps	2	Edwards, three-throw, 130 revolutions per minute	Cylinders 22 ins. diameter × 16 ins. stroke	Driven by 35-H.-P. C.C. motor.
Circulating pumps	3	Worthington triple expansion	Steam cylinders 6 ins. and 9 ins. and 16 ins. diameter × 15 ins. stroke; water cylinders, 20 ins. diameter × 15 ins. stroke	
Cooling towers	4	Barnard Wheeler, with one pair of fans to each	—	Fans driven by 35-H.-P. engines at 180 revolutions per minute.
Cooling towers	2	Klein towers	—	
Boilers	16	Babcock and Wilcox	Heating surface, 3,580 sq. ft. to evaporate 12,000 lbs. of steam per hour at 160 lbs. pressure	

ELECTRIC RAILWAY ENGINEERING

TABLE XXXVA.—*continued.*

Item.	Number.	Type.	Size and Rating.	Remarks.
Stokers	16	Vickers	Grate area, 90 sq.ft.	Driven by two 9½-H.-P. tandem compound engines.
Economisers	2	Green's patent	768 tubes	Scrapers driven by two 5-H.-P. motors.
Feed-pumps	3	Direct-acting duplex	Steam cylinders, 12 ins. and 18 ins. diameter × 15 ins. stroke; 16,000 gallons each per hour against 160 lbs. pressure per square inch	
Water tanks	2	—	20,000 gallons each	
Coal conveyer	1	Gravity bucket	60 tons per hour	Driven by 8-H.-P. motor.
Coal bunkers		—	1,000 tons capacity	

Coming next to the generating station of the Glasgow Corporation tramways, shown on Figs. 113 and 114, the generating station is situated in the northern district of the city, on the north bank of the Forth and Clyde Canal. The Caledonian and North British Railway Companies have sidings running over the outer storage hoppers.

The building consists of a framing of steel work supporting the coal hoppers and conveyer, main flues, and economisers, crane runway girders, and roof trusses, and enclosed with brick walls.

The firebrick lining in the chimneys is carried to a height of 150 ft., and varies in thickness from 18 ins. to 9 ins.

The engine house and boiler house floors are constructed of rolled steel beams filled in with concrete.

The main flues are supported on girders above the boilers, and enter the stacks at a height of 30 ft. above the boiler house floor.

They are constructed of ⅜-in. plating stiffened by steel angles. Branches constructed in the same manner are taken off to the economisers, which are fixed above the main flue, a separate connection being made to the stacks; dampers are arranged so that the economisers may be bye-passed when necessary. The uptakes from the boilers to the flues are made of ¼-in. plate.

The outside coal-handling arrangement consists of a bunker structure with two dumping tracks and eight hoppers for the high level line, and two dumping hoppers for the low level line. In addition to the coal dumping tracks on the high level line, a third track is laid between these two tracks to serve as a siding and for carrying the ashes from the ash chute outside the boiler house wall.

The inside coal bunkers are arranged in the centre of the boiler house, and extend the full length of the boiler batteries. The side plating is ¼ in. thick, and the bottom plating forming the hoppers is ⅝ in. thick. A bulkhead is arranged in the bunkers between each battery of boilers, the sides and bulkheads have stiffeners riveted to the plating 3 ft. apart, and each hopper is arranged with a 16-in. opening and valve at the bottom.

The coal runs through valves provided in the hoppers of the outer bunkers to

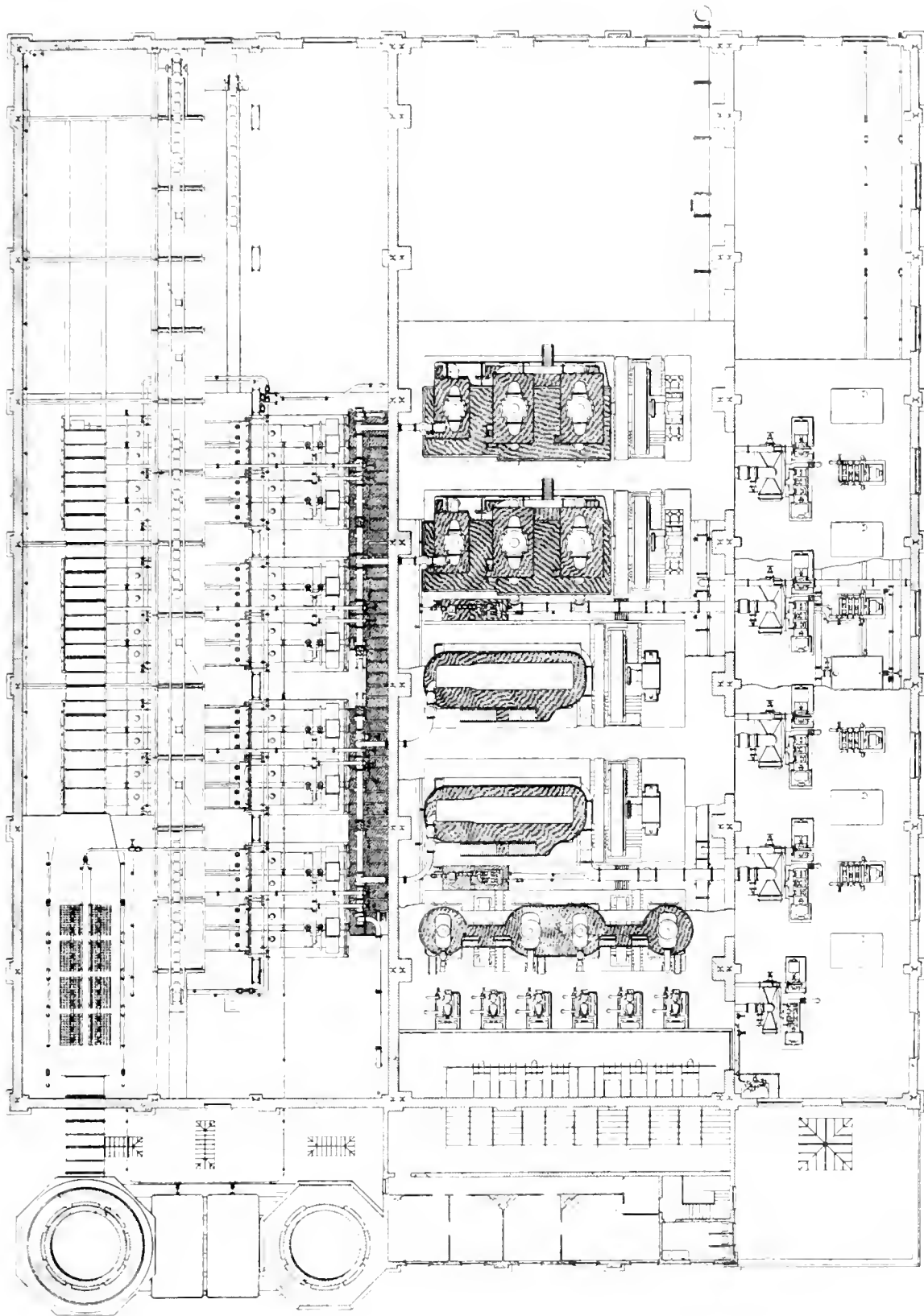

Fig. 113. GLASGOW CORPORATION TRAMWAYS: PLAN OF POWER STATION.

THE ELECTRICAL POWER GENERATING PLANT

the conveyer filler below, and is conveyed to the bunkers above the boilers, dimpling levers being provided over each bunker, so that the buckets may be tipped at any one of these.

Travelling ash fillers are provided in the basement, so that ashes may be run from the boiler ash-pits into the conveyer and transferred to the ash bunker at the end of the boiler house. This is periodically emptied by running the ashes through the spout into wagons on the siding outside the boiler house.

Below the valve of the overhead bunkers are fixed hoppers of the self-contained trolley type, with shuttes, and provided with a weighing scale. At the bottom of the

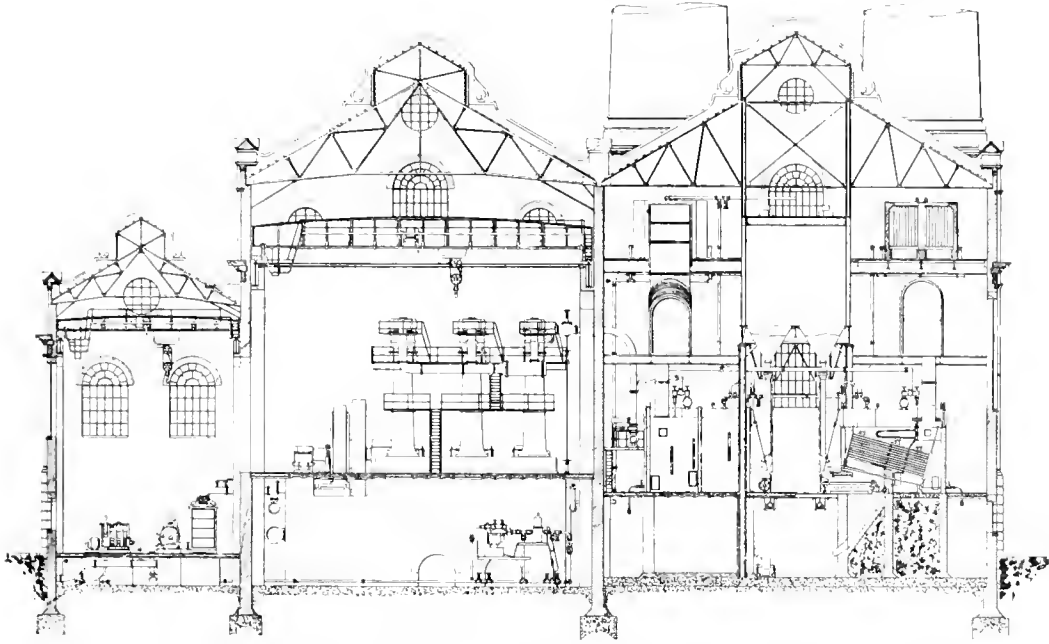

Fig. 114. GLASGOW CORPORATION TRAMWAYS: CROSS-SECTION OF POWER STATION.

shute is provided a balanced valve operated by a lever from the boiler house floor level, and from these shuttes the coal is delivered into the stoker hoppers.

The water supply for feed purposes is obtained from the Corporation mains through storage tanks, placed on girders between the stacks, the make-up water being supplied from these tanks through ball valves in the hot wells. The feed-pumps take their supply from the hot wells and deliver into a header in the engine house basement, which is connected up to each boiler feed ring, directly and also through the economisers. Each of the pump delivery branches to this header is provided with one feed-water filter (capacity 15,000 gallons per hour) and one water meter so arranged that either or both may be bye-passed.

The boilers are arranged in eight batteries of two boilers each.

The main steam piping consists of one main header, 16 ins. diameter, divided into two parts by means of expansion bends, which are provided with valves on each side for cutting off the steam. Each of the main parts of the header is further divided by 16-in. valves into two sections. Each of these four sections is connected to two batteries of boilers by two 9-in. pipes with 7-in. branches, and to one of the main engines by one 14-in. pipe for each of Nos. 1 and 2 engines, and a 15-in. pipe for

ELECTRIC RAILWAY ENGINEERING

each of Nos. 3 and 4 engines. By this arrangement it is possible to supply steam from two boilers directly to the corresponding engine, or the header may be used in common by the boilers and engines.

The auxiliary steam piping consists of a main range 10 ins. diameter connected to each end of the main steam header, and forming with it a complete ring; branches 7 ins. diameter are provided for the auxiliary engines, $3\frac{1}{2}$ ins. diameter for the exciter engines, and $2\frac{1}{2}$ ins. diameter for the boiler feed-pumps.

The exhaust piping between each main engine and its condenser, consists of two 24-in. vertical pipes, with bends bolted up to the exhaust branches on the two low-pressure cylinders of the engines, these two pipes being connected by means of bends and tees into a 30-in. pipe carried to the condenser; connection is also made through a stop valve and an automatic relief valve to the atmospheric exhaust pipe, which varies in diameter from 34 to 40 ins.

The auxiliary exhaust piping consists of one main range, 18 ins. diameter, connected up to the main exhaust piping through an 18-in. stop valve and automatic relief valve by a reducing pipe 18 ins. to 34 ins. diameter.

Between exciters 4 and 5 the diameter of the piping is reduced to 8 ins. diameter. Branches 14 ins. diameter are provided for the exciter engines, and 3 ins. diameter for the feed-pumps.

The air-pump discharge piping consists of a 14-in. main range running between the air-pumps and the hot wells, with 10-in. branches to the main air-pumps, 8-in. to the auxiliary pump, and 14 ins. diameter to the hot wells.

The suction piping from the canal to each main circulating pump is 15 ins., and for the auxiliary pump 10 ins. diameter, provided with foot valves and strainers at the canal intake.

The main discharge varies from 24 ins. to 30 ins. diameter, with 15-in. branches to the main condenser and 10-in. to the auxiliary condenser.

Blow-down piping from the boilers and economisers, drain piping from the tanks, hot wells, etc., are also provided, together with the piping and steam traps for efficiently draining the main and auxiliary steam piping.

The switch gear is designed to control the operation of four three-phase generators, together with the exciters, and for the distribution to five sub-stations of the following capacities:—2,500, 2,000, 1,500, 3,500, and 2,500 kilowatts.

The sizes and types of the various items of plant are given in Table XXXVb.

TABLE XXXVb.

Schedule of Type and Capacity of Plant Installed at the Generating Station of the Glasgow Corporation Tramways.

Item.	Number.	Type.	Size and Rating.	Remarks.
Main engines . . .	2	Vertical three-cylinder compound condensing, 75 revolutions per minute	Cylinders 42 ins. and 60 ins. and 60 ins. × 60 ins. stroke; full load, 4,000 I.H.-P.	
Main engines . . .	2	Ditto ditto .	Cylinders, 42 ins. and 62 ins. and 62 ins. × 60 ins. stroke; full load, 4,000 I.H.-P.	
Main generators . . .	4	Three-phase revolving field type, 6,500 volts, 25 cycles per second.	Full load, 2,500 kilowatts.	

THE ELECTRICAL POWER GENERATING PLANT

TABLE XXXVB.—*continued.*

Item.	Number.	Type.	Size and Rating.	Remarks.
Auxiliary engines	2	Vertical cross compound condensing, Corliss gear, 90 revolutions per minute	Cylinders 22 ins. and 41 ins. diameter × 42 ins. stroke; full load, 800 I.H.P.	
Auxiliary generators	2	Continuous-current compound-wound, 500 to 550 volts	Full load, 600 kilowatts	
Exciter engines	2	Vertical compound condensing, 300 revolutions per minute	Cylinders 11 ins. and 19 ins. diameter × 8 ins. stroke; full load, 85 I.H.P.	
Exciter generators	2	Shunt-wound	Full load, 50 kilowatts	
Main condensers	4	Horizontal type surface condensers	Cooling surface, 7,000 sq. ft.; capacity, 60,000 lbs. of steam per hour	
Main circulating pumps	4	Centrifugal	240,000 gallons of water per hour	Driven by 55-H.P. motor.
Main air-pumps	4	Edwards, three-throw, 150 revolutions per minute	Cylinders 16 ins. diameter, 12 ins. stroke; capacity, 60,000 lbs. of condensed water per hour	Driven by 27-H.P. motor.
Auxiliary condenser	1	Horizontal type surface condenser	Cooling surface, 2,800 sq. ft.; capacity, 24,000 lbs. of steam per hour	
Auxiliary circulating pump	1	Centrifugal	96,000 gallons of water per hour	Driven by 25-H.P. motor.
Auxiliary air-pump	1	Edwards, three-throw, 150 revolutions per minute	Cylinders 11 ins. diameter, 9 ins. stroke; capacity, 24,000 lbs. of condensed water per hour	Driven by 12-H.P. motor.
Boilers	16	Babcock and Wilcox	Heating surface, 5,173 sq. ft.; superheater surface, 452 sq. ft.; capacity, 20,000 lbs. of steam per hour at 160 lbs. pressure	
Stokers	16	Babcock and Wilcox chain grate	Grate area, 76 sq. ft.	Driven by four motors of 12-H.P.
Economisers	2	—	Capacity of each, 12,000 gallons per hour, raised from 90 to 160 F.	
Feed-pumps	4	Three-throw single-acting, 45 revolutions per minute	Plungers, 6 ins. diameter; capacity, 8,000 gallons of water per hour, against 180 lbs. pressure	
Water tanks	2	—	Capacity of each, 18,000 gallons	
Coal conveyers	2	Gravity bucket type	Capacity, 50 tons per hour each	
Coal bunkers	—	—	Capacity, 5,400 tons	

ELECTRIC RAILWAY ENGINEERING

We shall next describe the power station of the Bristol tramways (Fig. 115). This is interesting partly because it is built in storeys owing to the limitations of the ground at disposal.

The power house is situated at approximately the centre of the tramway system. The site adjoins the Floating Harbour and St. Philip's Street. An ample supply of condensing water can be obtained, and the facilities for the delivery of coal by means of barges are satisfactory.

Owing to the limited space, it was found necessary to arrange the boiler room above the engine room, and the concentration of the loads on a small area which resulted from this arrangement, together with the unsatisfactory nature of the soil, necessitated special precautions in designing the foundations.

The whole of the framing and walls of the power house, together with the stack, coal storage tank, and harbour wall, are supported on pitch pine piles 12 ins. to 14 ins. square, and about 30 ft. long.

The main columns are built up of Z bars and plates, the overall dimensions being 20 ins. \times 15 ins., and the sectional area 80 sq. ins.

Brackets are provided at a height of 36 ft. for supporting the crane runway girders.

The boiler house floor is at a height of 44 ft. above the engine room floor, and is carried by rolled beams supported by girders 5 ft. 6 ins. deep with flanges 16 ins. \times 2 ins., which in turn are supported on the main columns.

At the boiler house floor the dimensions of the main columns are 12½ ins. \times 10½ ins. and 25 sq. ins. area. These serve to support the main girders (5 ft. deep, flanges 16 ins. \times 1½ ins.) carrying the coal bunkers, water tanks, flue, and economiser. The main columns for supporting the roof above this level are of 9 ins. \times 4½ ins. 1 section.

The coal bunkers are constructed with sides of ¼-inch plating with stiffeners 3 ft. apart. The bottom plating forming the hoppers is ¾ in. thick. A 16-in. opening is provided to each hopper, to which is fixed a balanced valve. The coal storage tank consists of a circular shell of steel plating, the bottom being funnel-shaped and provided with an opening and valve.

The stack is constructed of steel plating varying in thickness from ¾ in. to ¼ in. The diameter at the top is 10 ft. 9 ins.; this increases gradually to 14 ft. at 25 ft. from the base; from this point it flares out to 20 ft. at the base.

The lining of firebrick varies in thickness from 9 ins. to 4½ ins., the bricks being specially made to the radius required.

The plating is riveted at the bottom to the cast iron base, which is anchored down to the brick base by means of eight 2½-in. bolts. This brick base is 60 ft. high, and contains the stairway for giving access to the boiler house.

The flue, which enters the steel stack at a height of 12 ft. from the base plate, is constructed of steel plating ¼ in. thick, stiffened by steel angles, and lined throughout with firebrick. The economiser is fixed at the side of the flue near the stack end, and dampers are provided so that the economiser may be cut out of service for repairs.

The coal is hoisted from the barges by means of the Hunt automatic shovel, into the Avery weigher at the top of the outside storage tank, into which it drops after the weight has been automatically recorded. The bottom of this tank is of a funnel shape, a valve being provided at the opening to regulate the flow of coal into the filler of the Hunt conveyer, which transfers the coal to the bunkers above the boilers. The conveyer returns through a trough below the boiler house floor, and openings are provided through which the ashes may be shovelled into the conveyer for conveyance to the ash tank, above which the buckets pass on their return to the coal filler below the storage

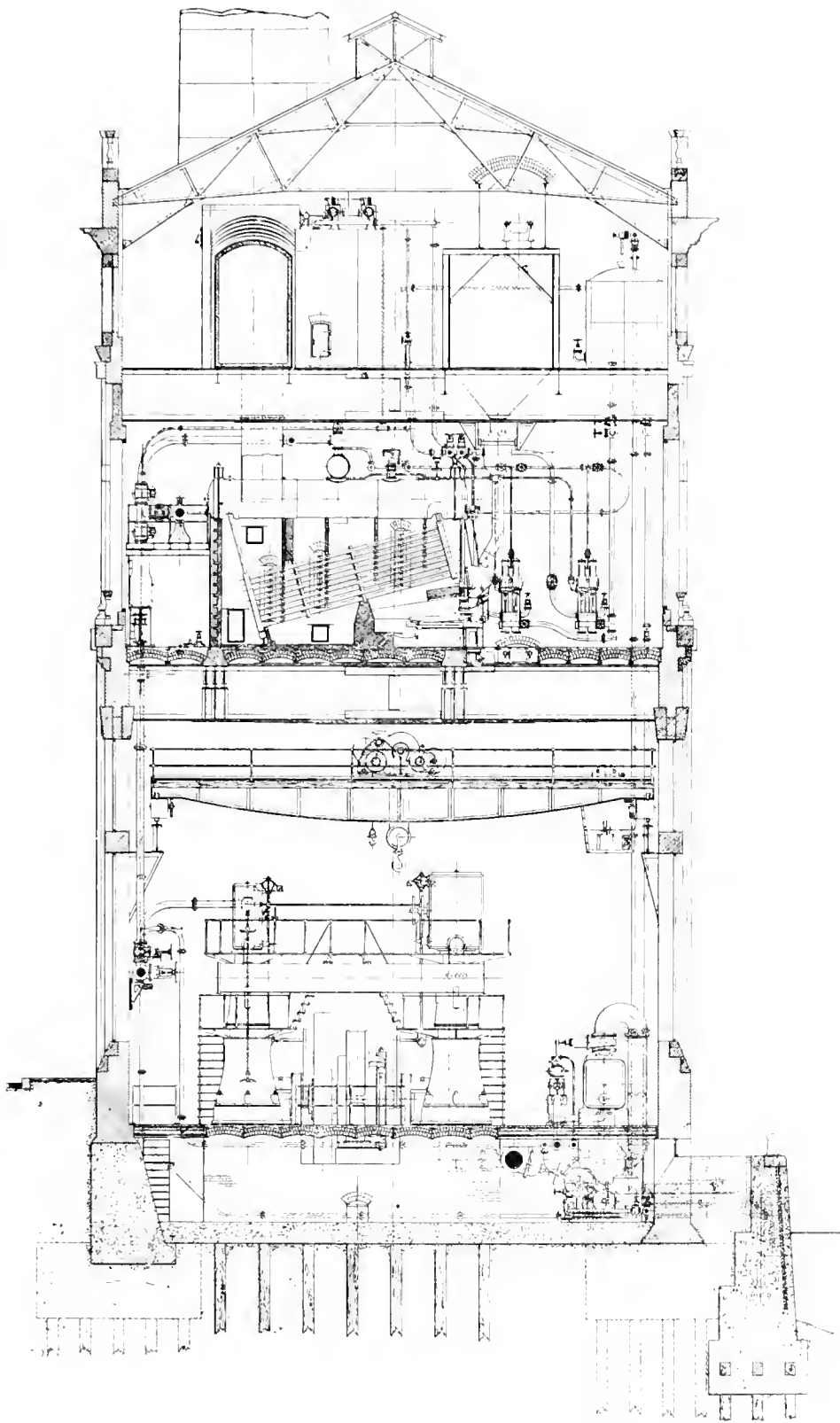

Fig. 115. BRISTOL TRAMWAYS: CROSS-SECTION OF POWER STATION.

ELECTRIC RAILWAY ENGINEERING

tank. The conveyer thus serves both purposes at the same time. The ash tank is provided with a valve and spout, by means of which the ashes can be run out into barges.

The water supply for feed purposes is obtained from the city mains. Owing to its hardness, a water softener was installed to obviate boiler troubles due to deposit in the tubes.

The feed-pumps take their supply of water from the storage tanks above, and deliver through the economiser into a duplicate system of piping provided with branches to each of the boilers.

The boilers are arranged in four batteries of two boilers each. Steam is conveyed directly from each battery to the main header in the engine room, from which there is a branch to each engine. This header is divided by a valve into two sections. There is in addition a duplicate header in the boiler room to which each battery is connected, and by means of which it is possible to supply steam from any of the boilers, whilst part of the engine room header may be out of service for repairs.

A connection is made to each end of the engine room header for a supply to the auxiliary plant. This forms a ring system, so that steam may be taken from either end of the header.

The exhaust piping is so arranged that any of the engines can exhaust to either condenser, and as one condenser, with its circulating pump and air-pump, is capable of dealing with the total load, repairs can always be effected without exhausting to the atmosphere.

The air-pumps deliver into a hot well in the basement, from which the water is drawn by the three-throw pumps and forced through Railton and Campbell filters up to the storage tanks. The additional water required to make up losses, etc., is supplied from the water softener through a ball valve in the hot well.

The steam piping, etc., is all drained in an efficient manner by means of Geipel steam traps, the condensed water being led away to the hot well.

The switchboard is situated on a gallery at the end of the engine room at a height of 12 ft. from the floor.

The schedule in Table XXXVc. contains types and sizes of plant installed in this station.

TABLE XXXVc.

Schedule of Type and Capacity of Plant Installed at the British Tramways Generating Station.

Item.	Number.	Type.	Size and Rating.	Remarks.
Main engines	4	Vertical cross-compound condensing, Corliss gear, 90 revolutions per minute	Cylinders 22 ins. and 44 ins. diameter & 42 ins. stroke, 800 I.H.-P.	
Main generators	4	Continuous current compound-wound, 500-550 volts	Full load, 550 kilowatts; overload, 25 per cent. for 2 hours	Efficiency: full load, 94.5 per cent; half-load, 94 per cent.; quarter-load, 91 per cent.
Auxiliary engines	2	Vertical compound, 400 revolutions per minute	Full load, 75 I.H.-P.	
Auxiliary generators	2	Continuous current compound-wound, 500-550 volts	Full load, 50 kilowatts	

THE ELECTRICAL POWER GENERATING PLANT

TABLE XXXVc.—*continued.*

Item.	Number.	Type.	Size and Rating.	Remarks.
Motor generators	3	Motor 500-volt shunt-wound Generator, series wound	50 kilowatts.	
Condensers	2	Horizontal type surface condensers	Cooling surface, 3,200 sq. ft.	
Air-pumps	2	Vertical twin type	Steam cylinders 7½ ins. diameter by 8 ins. stroke; pump cylinders 17½ ins. diameter	
Circulating pumps	2	Centrifugal		Driven by 29-H.P. motors.
Lift pumps	2	Three-throw, single-acting	Plungers, 6½ ins. diameter, 8 ins. stroke	Driven by 15-H.P. motors.
Boilers	8	Babcock and Wilcox	Heating surface, 3,140 sq. ft.; 8,250 lbs. of steam per hour at 150 lbs. pressure	
Stokers	8	Vickers type	Grate area, 45 sq. ft.	
Economiser	1	Green's patent	360 tubes	
Feed-pumps	3	Vertical compound duplex	Steam cylinders 5 ins. and 10 ins.; water cylinders 5 ins. diameter × 10 ins. stroke	
Water tanks	2	—	6,000 gallons each	
Water softener	1	Tyacke patent	3,000 gallons per hour	
Coal conveyer	1	Gravity bucket type	60 tons per hour	Driven by 15-H.P. motor.
Coal hoist	1	Hunt automatic shovel	60 tons per hour.	
Coal bunkers	—	—	800 tons capacity.	

We shall now describe the power station of the Dublin United Tramways, illustrated in Figs. 116, 117 and 118.

The generating station is situated at Ringsend, adjacent to the Grand Canal Dock, and is built upon hard gravel and blue clay. The building is composed of a steel framework, enclosed with brickwork, and rests on heavy concrete foundations. Two main bays, one housing the boilers and coal storage, and the other containing the generating and distributing machinery, are separated by a party wall, the engine room being 80 ft. and the boiler room 76 ft. wide. The entire building is above ground, the engine room floor level being 12½ ft. above the general ground level, thus ensuring ample light and ventilation.

The coal is taken from barges at the quay side by a grab suspended from a hoisting tower. The grab, which holds one ton, lifts the coal and drops it into a small truck, which, after being automatically weighed, travels down an incline, and dumps the coal at a predetermined point into the coal store, of 800 tons capacity, adjoining the end of the boiler room. From this store the coal drops into a gravity bucket conveyer, and is delivered to the coal bunkers, of 1,200 tons capacity, situated above the central space between the two ranges of boilers. The whole series of operations is automatic, and a minimum of attention is required.

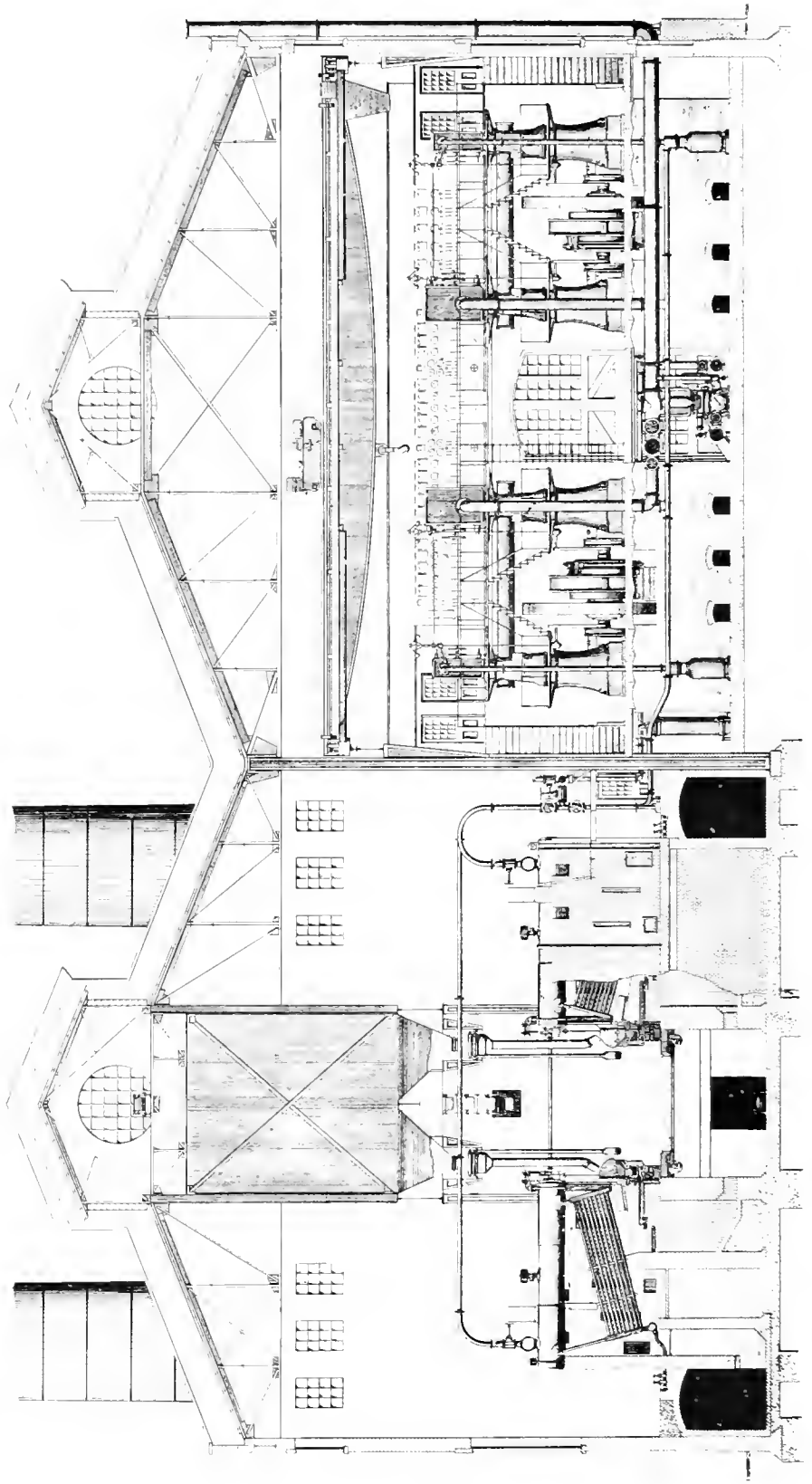
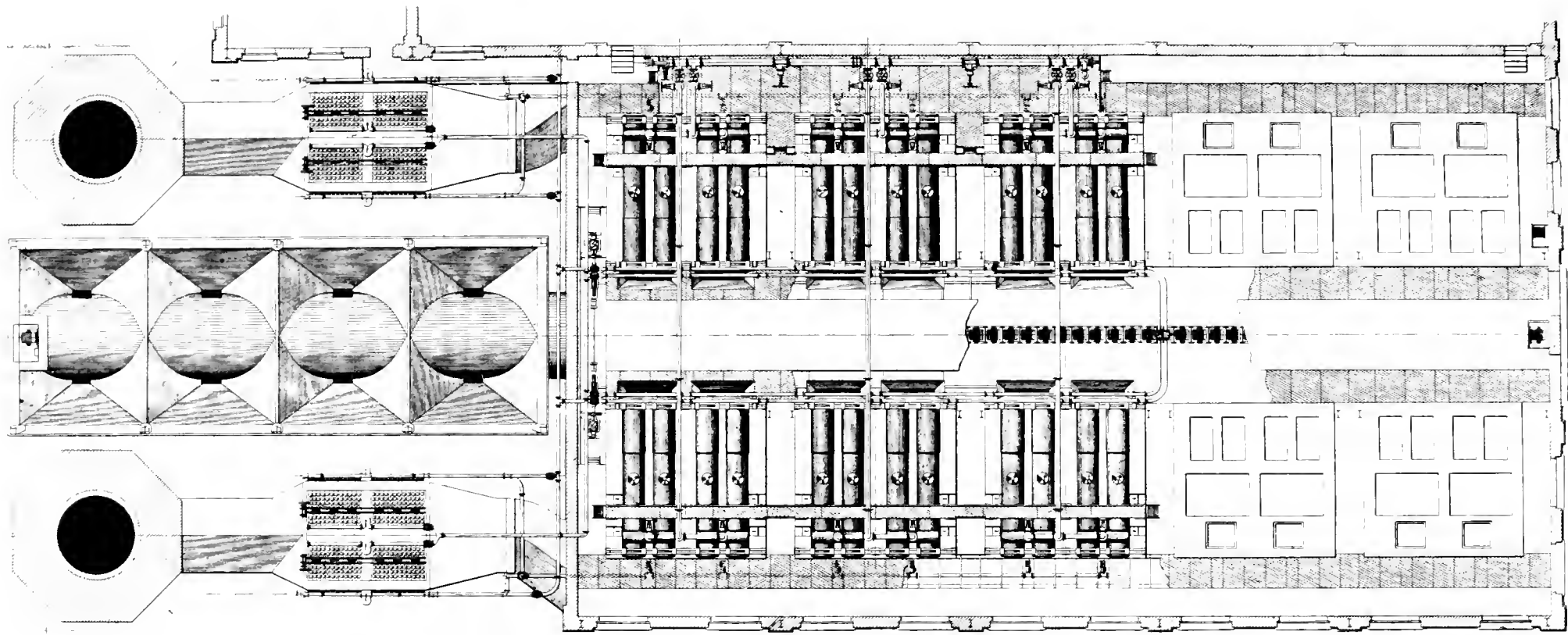
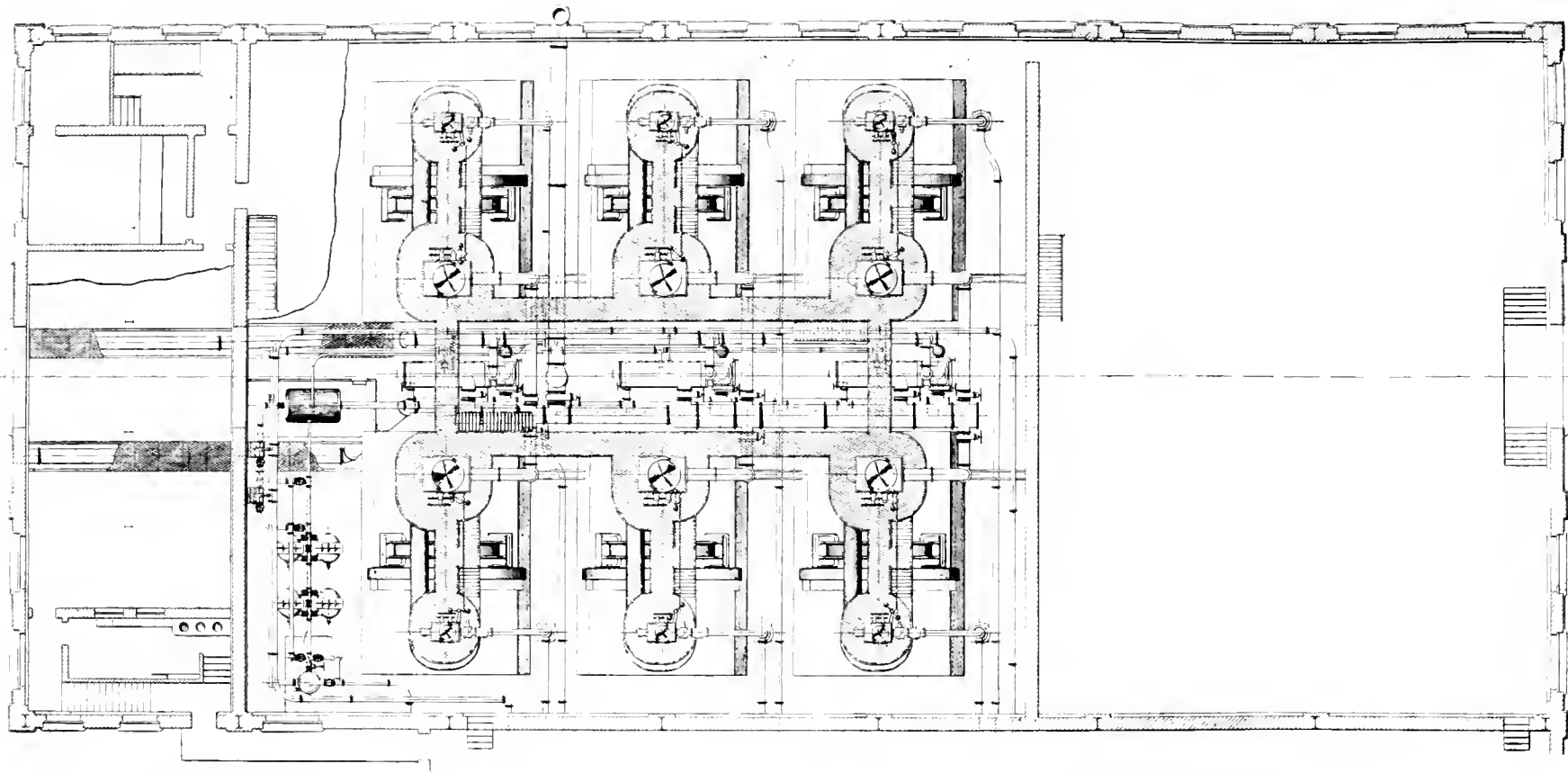

Fig. 116. DUBLIN UNITED TRAMWAYS: CROSS-SECTION OF POWER STATION.



SCALE OF FEET

Fig. 117. ARRANGEMENT OF BOILER PLANT OF DUBLIN UNITED TRAMWAYS GENERATING STATION



— SCALE OF 1/4" = 1' —

Fig. 118. PLAN OF ENGINE ROOM OF DUBLIN UNITED TRAMWAYS GENERATING STATION.

THE ELECTRICAL POWER GENERATING PLANT

The boilers are arranged in six batteries of two boilers each, three batteries being ranged on each side of the boiler room. They are of the Babcock and Wilcox water tube type, with steam and water drums 36 ins. diameter, and 21 ft. 4 ins. long, and are fitted with automatic stokers, operated by a driving shaft beneath the boiler room floor.

The gases leaving the boilers are conducted by means of two flues, one each side of the boiler house, to the economisers, situated on either side of the outside coal store, and finally to the two chimneys. These chimneys are of steel plate, with fire-brick lining, and rest on brick bases, octagonal in shape. They are 230 ft. in height, with an inside diameter of 10 ft.

The steam piping is arranged so that one battery can supply one engine direct, forming an independent unit, while the main steam header enables the boilers and engines to be interchanged.

The main engines are vertical cross-compound condensing and direct coupled to 500-kilowatt generators, and the units are arranged in rows, with ample floor space in the centre of the engine room.

There are three surface condensers situated in the centre of the engine room basement, each condenser being between the foundations of two main units, and capable of dealing with the exhaust steam from both. These condensers are provided with combined steam-driven air and circulating pumps, and are all interchangeable, thus facilitating the combination of any two generating sets with either condenser. The feed-pumps, two in number, are of the vertical duplex tandem compound type, and each is capable of dealing with the whole of the necessary feed water, which is pumped through a feed water heater and duplicate filters on its way to the boilers. This heater takes the exhaust from the feed-pumps, air and circulating pumps, and the small stoker engines, and the water of condensation is drained into a cylindrical hot well, which also receives the air-pump discharge and clean steam drains. The level in the hot well is maintained by a make-up supply from the circulating discharge, and thus provides a continuous supply of hot feed water.

The engine room is equipped with a 25-ton overhead crane, electrically operated by three separate motors, which are controlled from a cage suspended from the bridge girders. The cage is situated so that the operator has a clear view of the engine-room. The hoisting speed of the crane is from 4 to 50 ft. per minute, according to the weight, and the travelling speed is 60 ft. per minute in both directions. The switchboard is situated at the permanent end of the engine room, on a gallery 16 ft. from the engine room floor, and is approached by means of two iron staircases.

The switchboard extends almost the entire width of the engine room, sufficient space being left on either side for access to the back of the board and to the offices. The panels comprising the board are bolted to suitable sustaining angle irons by nickel-plated bolts.

At the back of the switchboard, and in three storeys, are situated the store rooms, workmen's quarters, and various offices for engineers and switchboard attendants, the whole being well equipped with lavatories, bath-rooms, etc. The entire power-station and outside coal-handling apparatus is thoroughly well lit by an elaborate system of arc lighting and incandescent lamps.

A schedule setting forth the types and sizes of the plant installed, is given in Table XXXVd.

ELECTRIC RAILWAY ENGINEERING

TABLE XXXVd.

Schedule of Type and Capacity of Plant Installed at the Generating Station of the Dublin United Tramways Co.

Item.	Number.	Type.	Size and Rating.	Remarks.
Main engines	6	Vertical cross-compound condensing, Corliss gear, 90 revolutions per minute	Cylinders 20 ins. and 40 ins. \times 42 ins. stroke, 800 I.H.-P.	Steam consumption at full load, 13.25 lbs. per I.H.-P. saturated, 150 lbs. pressure, 27 ins. vacuum.
Main generators	6	C.C. 500 volts	Full rated load, 550 kilowatts	Efficiency: full, 94 per cent.; half, 95 per cent.; quarter, 93 per cent.
Boosters	3	500 volts motor, 30 volts generator	15 kilowatts	
Boosters	1	Ditto ditto	24 kilowatts	
Condensers	3	Horizontal surface	2,400 sq. ft.	
Air-pumps	3		16 ins. diameter, 16 ins. stroke	Combined and driven by tandem steam engine cylinders, 7 ins. and 14 ins.
Circulating-pumps	3		18 ins. diameter, 16 ins. stroke	Ditto ditto.
Feed-pumps	2	Vertical duplex tandem compound	8,000 gallons per hour, 5 ins. and 10 ins. \times 10 ins. stroke	
Travelling crane	1	Electrical overhead	25 tons	
Boilers	12	Babcock and Wilcox water tube	2,530 sq. ft.	
Stokers	12	Vickers		
Conveyor	1	Gravity bucket	50 tons per hour	10 H.-P. motor-driven.
Shutes	6	Weighing and travelling	8 cwt. capacity	
Hoisting tower	1	Steam-driven grab	40 tons per hour	
Economisers	2	Green's patent	192 tubes each	Motor-driven scraper gear.

Although giving good results, and possessing individual features contributing to high overall efficiency, none of the stations described embody all the details or fulfil all the conditions set forth earlier in this chapter as necessary to obtain the best possible results. This is chiefly due to the location of these stations being such as to preclude the greatest advantages being obtained. Lack of a natural supply of cooling water in one case, restricted ground area in another, and the fact that they have all been in service a good number of years, tend to limit the efficiency of the power stations described.

Figs. 119 and 120 illustrate a turbine power station designed on the principles already outlined, and may be taken as representing, both in arrangement and detail, the best practice in modern central station design.

This station is equipped with five 2,000-kilowatt turbines of the vertical type, and supplied with steam at 150 lbs. pressure and 200 degrees superheat from ten marine type, water-tube boilers.

The condensers are of the barometric jet type in duplicate, each set taking care

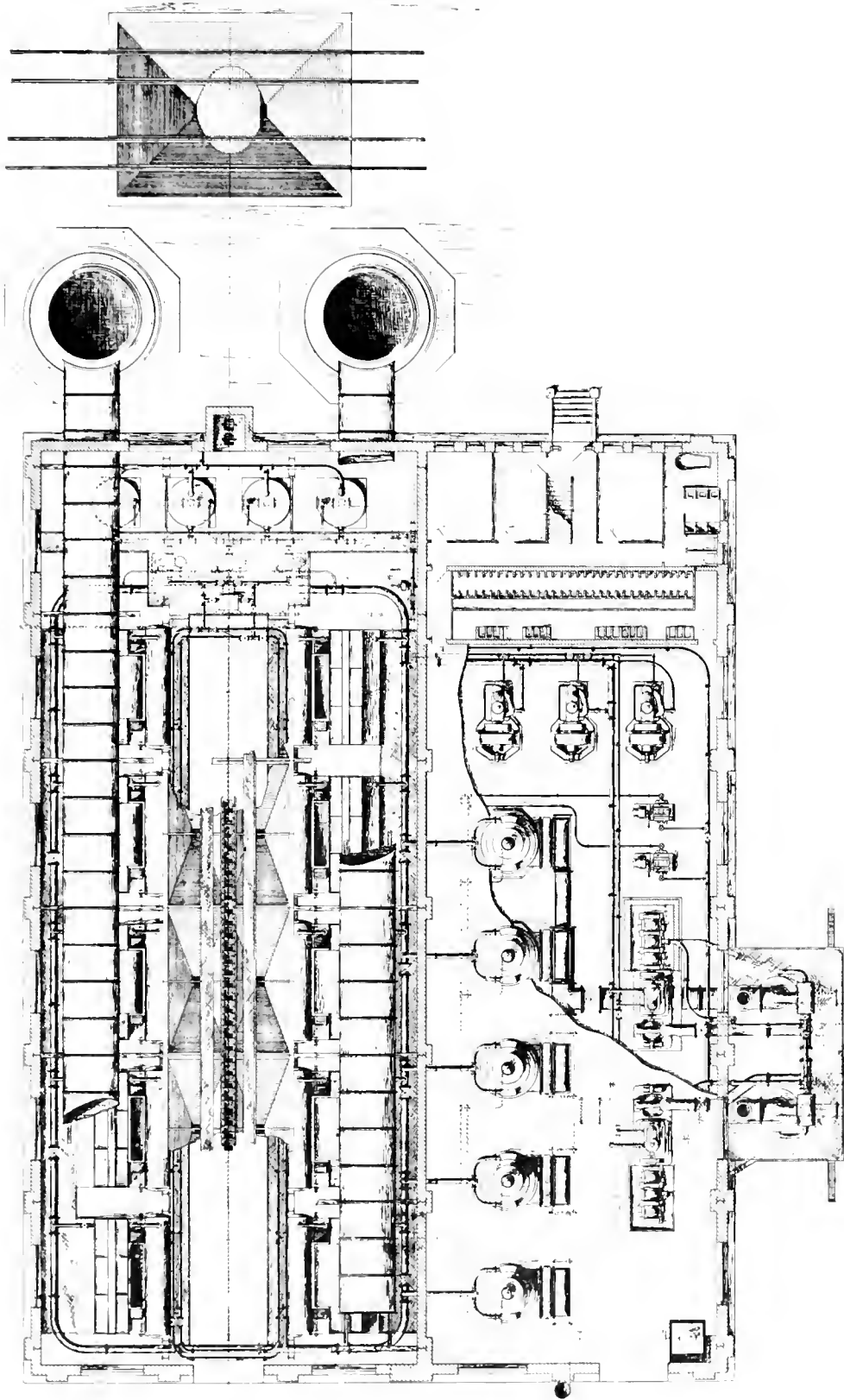

Fig. 119. DESIGN OF 10,000-K.W. POWER STATION. PLAN.

ELECTRIC RAILWAY ENGINEERING

of half the station. The water is circulated by centrifugal pumps, and the air extracted by single-acting three-throw wet air-pumps.

The feed water passes from overhead storage tanks through heater detartarisers on its way to the feed-pumps, and is raised to the atmospheric boiling point by the exhaust steam from the auxiliaries.

The feed-pumps are situated with a head on the suction side, thus enabling them to deal with the water at this temperature.

The coal is handled automatically by gravity conveyors; the boilers are provided with automatic stokers, and the ashes are removed from the boiler room basement in

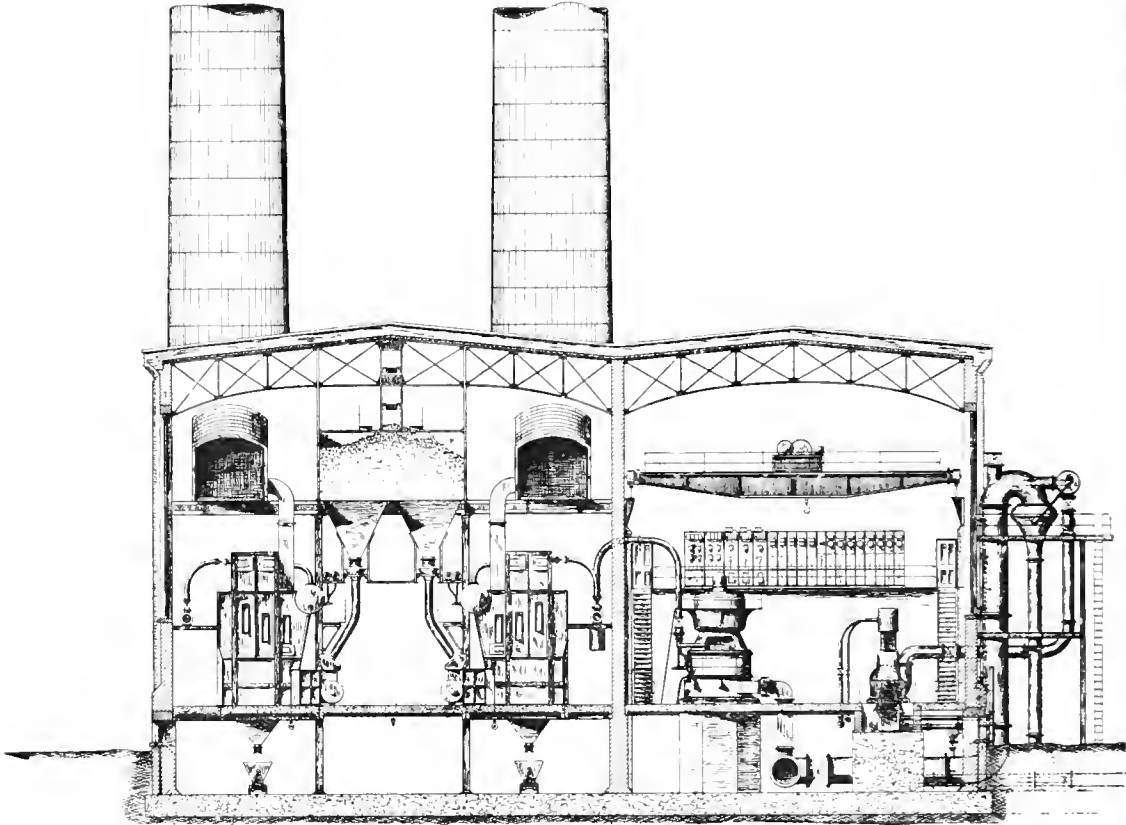

Fig. 120. DESIGN OF 10,000-K.W. POWER STATION. CROSS-SECTION.

trucks. The turbines maintain a low steam consumption over a wide range, the piping throughout is of the simplest nature, and a vacuum of 28 ins. is maintained.

Dealing next with the cost of operating and maintaining a generating station plant, we propose setting forth the working costs of a number of power stations, first as recorded and in the next place in such a manner as to enable an absolute comparison to be made. It is not an easy matter in making comparison between the returns of working of different power stations to obtain a common basis for comparison. The first difficulty one encounters is with regard to the cost of coal. The cost is given usually in pence per kilowatt hour, and it is seldom that the average price per ton paid for the coal is mentioned. Another difficulty arises out of the uncertainty as to the meaning of the term "units generated." This ambiguity arises from the use in some cases of

THE ELECTRICAL POWER GENERATING PLANT

electricity for running a part or the whole of the auxiliary plant, and from inclusion in the total by some, and exclusion by other engineers, of the energy so used when computing the cost per unit. Where the energy used for auxiliary purposes is included, it precludes a fair comparison with other stations where the auxiliary plant is steam-driven.

In the following tables we have, from the total energy generated, deducted all energy used in the power house for auxiliary purposes, including excitation where necessary, and have adopted the term "energy issued out of power station," as conveying this meaning without ambiguity, so that it is clear that comparisons of the working expenses of different power stations are made on the same basis. Table XXXVI. gives the operating cost of the plants already described.

TABLE XXXVI.
Operating Costs of Electrical Power Generating Stations.

	Glasgow Corporation Tramways.	Central London Railway.	Dublin United Tramways.
Total kilowatt hours generated per annum	23,918,863	18,552,546	8,624,125
.. .. used in power station	919,488	612,762	147,354
.. .. issued out of power station	23,000,512	17,939,784	8,476,771
Total coal consumed, tons	35,267	29,225	16,488
Coal per kilowatt hour (issued from station), pounds	3.43	3.65	1.36
Cost pence	0.12	0.317	0.226
Cost of coal per ton shillings	6.52	16.25	9.68
<i>Cost in pence per kilowatt hour issued: -</i>			
<i>Operation:</i>			
Salaries and wages	0.104	0.088	0.123
Fuel	0.120	0.317	0.226
Water	0.008	0.0012	0.007
Oil, waste and stores	0.014	0.0140	0.016
<i>Repair and maintenance:</i>			
Material and wages	0.036	0.0160	0.033
Total	0.282	0.4662	0.405

We now present a series of tables in which an absolute comparison is made of the working of various plants differing in magnitude and in the extent of use and setting forth in each case the overall efficiency of the plant in terms of the energy contained in the coal, the efficiency being defined as the ratio of the energy issued out of the power station to the energy contained in the coal.

The following table (XXXVII., on p. 134), is a comparison of the overall efficiency of three of the plants described, and inasmuch as the plant is in each case of the same class, the comparison is a valuable one.

It will be noted that the overall efficiency increases with the magnitude of the plant owing to the higher efficiency of the larger units. In order to determine approximately the law of efficiency in this respect, we have analysed the returns of a large number of stations both in this country and in other countries.

Twenty-six of these stations are classified in three groups in Table XXXVIII. on pp. 136 and 137. In each group, one-half represents British stations, and one-half represents stations outside of Great Britain. Two considerations controlled the choice of stations for inclusion in the investigation. The first consideration was that the available data should include as many as possible of the facts affecting the

ELECTRIC RAILWAY ENGINEERING

annual overall efficiency; the second consideration was that the range of capacities and the average capacity of the British stations should be about equal to the range of capacities and the average capacity of the stations located outside of Great Britain. This selection was made without any reference whatever to the value of the resulting average efficiencies.

TABLE XXXVII.
Annual Overall Efficiencies of Three Electrical Power Generating Stations.

Installation.	Glasgow Corporation Tramways.	Central London Railway.	Dublin United Tramways.
	1905.	1905.	1905.
Total rated capacity (kilowatts)	11,200	5,100	3,600
Kilowatt hours generated per annum	23,918,863	18,552,546	8,624,125
„ „ issued out of power station per annum	23,000,512	17,939,784	8,476,771
Maximum output, kilowatts	8,520	5,000	3,000
Load factor	32	41·4	32·2
Coal consumed, tons	35,267	29,225	16,488
Calorific value (B.T.U.) per lb.	12,600	14,500	12,500
„ „ kilowatt hours per ton	8,270	9,540	8,230
Kilowatt hours input per kilowatt hour output	12·65	15·5	16
Annual overall efficiency	7·9	6·4	6·25
Coal cost per ton, shillings	6·52	16·25	9·68
Cost of coal per kilowatt hour of calorific value, pence	0·00949	0·0204	0·0141
Final cost of electrical energy per kilowatt hour of output, pence	0·12	0·317	0·226

The table gives the output of the station for the period considered, in millions of kilowatt hours per annum. The stations are arranged in the order of their annual outputs. In the table are also compiled those particulars of each station which could be expected to have a bearing upon the overall efficiency, together with the data necessary for calculating this overall efficiency. The annual input of energy in the form of the energy of combustion of the coal, the annual output in millions of kilowatt hours of electrical energy, and the annual overall efficiency are likewise recorded for each of the twenty-six stations.

In Table XXXIX. these results are averaged for the British stations and for the stations situated outside of Great Britain.

TABLE XXXIX.
Annual Overall Efficiencies of English and Foreign Electrical Generating Stations.

Class.	Great Britain (B) or Abroad (A).	Average Output from Generating Station during Year in Millions of Kilowatt Hours.	Average Efficiency of Generating Station in per cent.
Between 0·9 and 3·3 millions of kilowatt hours per year	B	2·0	2·8
	A	1·9	5·2
Between 6 and 13 millions of kilowatt hours per year	B	9·3	5·8
	A	9·9	6·6
Between 18 and 45 millions of kilowatt hours per year	B	28·8	7·2
	A	32·6	8·3

In Fig. 121 these average results are plotted in the form of curves showing the annual overall efficiency of the generating stations as a function of the millions of kilowatt hours of annual output.

THE ELECTRICAL POWER GENERATING PLANT

It is to be regretted that the published returns from generating stations are not more complete. Thus we naturally ask ourselves whether it might not be possible to trace a connection between the overall efficiency and the extent to which electrical storage batteries are employed, but we find that the incompleteness of our data makes this impossible. It is fair to assume that all these stations were operated condensing although this fact is recorded only in the case of the British stations. In fact, non-condensing stations, when known to be such, were purposely excluded from the comparison. In no case, however, are there records of the average vacuum maintained, nor of the average amount of superheat employed. The comparison of the capital cost and the rate of depreciation would also have been impracticable, owing to the insufficiency of the published data, and hence one cannot assert conclusively that the one or the other set of generating stations represents the better engineering.

It is, however, quite evident that even the better of the two efficiency curves of Fig. 121 is very low. The efficiency of steam generating sets at full-load frequently

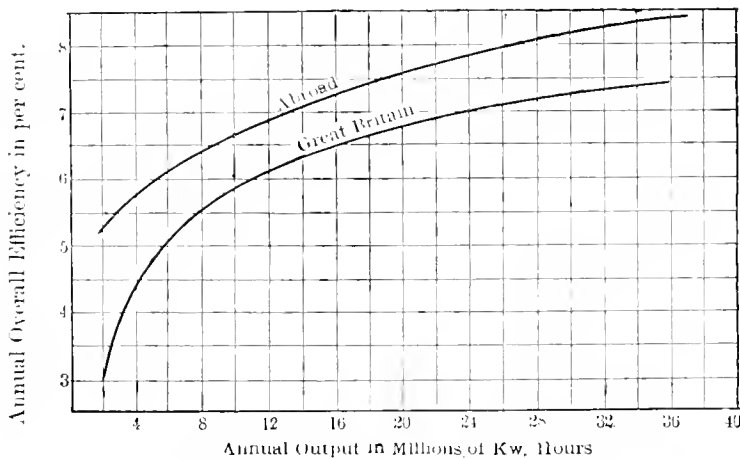

Fig. 121. COMPARISON OF EFFICIENCIES OF ENGLISH AND FOREIGN ELECTRICAL GENERATING STATIONS.

exceeds 20 per cent. in larger sizes, and the efficiency of a good boiler working at its rated capacity should not fall below 75 per cent. Taking the efficiency of the steam piping at 95 per cent., there is obtained a practicable full-load overall efficiency of the generating station of $0.20 \times 0.75 \times 0.95 = 0.14$.

The difference between this efficiency and that actually obtained in practice, is due chiefly to the circumstances that the plant is run for a large part of the time at considerably less than full load, that fires must be kept under one or more spare boilers, that the boilers and engines are not maintained in the condition of highest efficiency, that the supply of air to the fires is not suitably regulated, that the coal is not uniformly of the calorific value of the samples tested, and to various other detail circumstances.

As shown in Table XXXIX., it is not unusual to find large stations with an annual overall efficiency of over 7 per cent.

ELECTRIC RAILWAY ENGINEERING

TABLE
Annual Overall Efficiencies of Twenty-

Class	Millions of Kilowatt Hours delivered from Generating Station per Year.								
	Condensing or Non-condensing.	British Station (B) or Abroad (A).	Accumulators employed or not in Generating Station.	Kilowatt Hours delivered by Accumulators during Year.	Kilowatt Hours by Accumulators in per cent. of Total Kilowatt Hours.	Steam superheated or not.	Average Amount of Super-heat in Degrees Cent.	Quality of Coal used.	
Between 0.9 and 3.3 Millions of Kilowatt Hours per Year.	0.95	Not stated	A	Accumulators employed	177,600	18.7	Not stated	Not stated	German bituminous
	0.97	Not stated	A	Accumulators employed	148,880	15.4	Not stated	Not stated	German bituminous
	1.00	Condensing	B	Not stated	Not stated	Not stated	Not stated	Not stated	Not stated
	1.00	Condensing	B	Not stated	Not stated	Not stated	Not stated	Not stated	Not stated
	1.18	Not stated	A	Accumulators employed	200,200	17.0	Not stated	Not stated	Westphalian anthracite
	1.33	Condensing	B	Accumulators employed	Not stated	Not stated	Superheated	28	Small peas
	2.07	Not stated	A	Accumulators employed	262,738	12.7	Not stated	Not stated	Westphalian bituminous
	2.25	Condensing	B	Accumulators employed	Not stated	Not stated	Superheated	Portion slightly superheated	Best Welsh
	2.30	Condensing	B	Accumulators employed	Not stated	Not stated	None	Not stated	Derby pea nuts
	3.02	Not stated	A	Accumulators employed	211,000	7.0	Not stated	Not stated	Derby pea nuts Yorkshire steam
Between 6 and 13 Millions of Kilowatt Hours per Year.	6.3	Not stated	A	No accumulators employed	Not stated	Not stated	Not stated	Not stated	German lignite
	8.2	Condensing	B	Not stated	Not stated	Not stated	Not stated	Not stated	Not stated
	9.0	Not stated	A	Accumulators employed	Not stated	Not stated	Superheated	Not stated	German lignite
	9.4	Condensing	B	Not stated	Not stated	Not stated	Superheated	Part superheated to 2.8	Smudge
	9.5	Condensing	B	Not stated	Not stated	Not stated	None	Not stated	Slack
	10.1	Condensing	B	Accumulators employed	Not stated	Not stated	Superheated	28 to 508	Slack
	11.9	Not stated	A	Accumulators employed	Not stated	Not stated	Not stated	Not stated	Lignite briquettes and 2.8 coke
	12.5	Not stated	A	Accumulators employed	Not stated	Not stated	Not stated	Not stated	Cardiff and Westphalian
	18.1	Condensing	B	Not stated	Not stated	Not stated	Not stated	Not stated	Not stated
	23.0	Condensing	B	Accumulators employed	Not stated	Not stated	Superheated	Superheated to 2.0	Washed nuts
Between 18 and 45 Millions of Kilowatt Hours per Year.	26.7	Not stated	A	Accumulators employed	2,491,000	9.4	Not stated	Not stated	Westphalian bituminous
	29.6	Not stated	A	Accumulators employed	275,000	0.93	Not stated	Not stated	Cardiff
	41.7	Not stated	A	Accumulators employed	1,188,000	2.86	Not stated	Not stated	German lignite
	45.0	Both	B	Accumulators employed	Not stated	Not stated	Superheated	Part superheated to 508	Washed slack

We shall now put forward a table (XL.) of thermal efficiencies of power station plants which cover a wide range of load factors and size of generating units.

In the preparation of this table we have not adopted any impossible ideal, but wish it to be understood that the figures given for efficiencies are within the range of possibilities, and have been attained in one or two instances. In the preparation of the table we have embodied all the principles set forth in this chapter, and the plants are taken as provided with superheaters, economisers, feed-water heaters, steam-driven auxiliaries, with boilers and condensers properly proportioned, and an ample supply of circulating water for the condensers and at a convenient level.

It is not often that it is possible to obtain all the advantages in one plant. Water

THE ELECTRICAL POWER GENERATING PLANT

XXXVIII.

six Electrical Generating Stations.

Calorific Value in Kilo-watt Hours per Ton.	Number of Tons of Coal Burned per Year.	Price in Shillings per Ton.	Use to which the Excess Energy is put, Light, Heat, Traction, E., Power, P.	Average Load Factor of Generating Station per Year.	Date of End of Year for which Data applies.	Year of Working.	Total Kilowatt Hours of Calorific Value of Coal Burned per Year.	Total Output in Kilo-watt Hours during Year.	Efficiency of Combustion Section in per cent.
8,000	2,080	21.4	L. P. T.	18.8	1904	6th	17,200,000	948,000	5.5
8,500	2,730	9.6	L. P. T.	27.5	1903—1904	4th	23,200,000	1,055,000	4.54
9,000	3,100	11.0	L. T.	15.4	March, 1904	6th	27,900,000	1,000,000	3.58
7,700	4,250	11.5	L.	16.0	March 25, 1904	7th	32,700,000	1,090,000	3.34
8,150	3,458	18.0	L. P. T.	14.05	1903—1904	5th	28,200,000	1,177,000	4.2
9,100	8,200	7.7	T.	13.8	March, 1903	10th	74,500,000	1,230,000	1.70
9,050	4,190	14.2	L. P. T.	43.6	1903—1904	5th	37,900,000	2,070,000	5.5
8,500	17,300	10.75	T.	11.6	March 31, 1904	6th	147,000,000	2,250,000	1.52
9,500	11,300	12.3	L.	12.1	March 31, 1903	10th	107,300,000	2,000,000	2.7
8,320	5,040	12.6	L. P. T.	20.5	1903—1904	12th	49,400,000	3,020,000	6.1
7,100	10,800	8.2	T.	17.4	March 15, 1904	Not stated	76,600,000	3,120,000	4.06
7,100	7,500	16.3	L. P. T.	13.7	1903—1904	14th	53,200,000	3,250,000	6.1
5,600	22,580	10.1	L. P.	15.0	1904	11th	126,300,000	6,260,000	4.95
8,020	16,500	9.75	T.	Not stated		Not stated	132,500,000	8,200,000	6.2
2,800	45,000	Not stated	T.	7.97	1904	9th	126,000,000	8,088,000	7.14
7,060	26,100	5.0	L. P.	14.5	March 25, 1905	Not stated	184,000,000	9,400,000	5.1
7,700	20,300	8.2	T.	Not stated	March 25, 1904	11th	156,500,000	9,500,000	6.05
9,320	18,000	7.7	L. P. T.	28.6	March 31, 1905	Not stated	168,000,000	10,100,000	6.10
8,350	20,800	13.0	L. P. T.	38.1	1904	13th	173,500,000	11,800,000	6.85
8,750	19,800	Not stated	L. P. T.	40.1	1904	10th	173,000,000	12,480,000	7.21
9,200	30,184	16.45	T.	Not stated	April, 1905	Not stated	200,000,000	18,100,000	6.45
8,100	35,270	6.4	T.	30.8	May 31, 1905	5th	286,000,000	23,000,000	8.06
8,750	40,800	17.1	L. P. T.	31.5	1903—1904	16th	357,000,000	26,650,000	7.48
8,750	45,800	Not stated	L. P. T.	Not stated	1904	5th	385,000,000	29,600,000	7.75
7,750	56,000	Not stated	L. P. T.	35.2	1904	3rd	437,000,000	41,500,000	9.61
8,940	75,000	10.0	L. P. T.	25.5	March 31, 1905	Not stated	670,000,000	45,000,000	6.72

for condensing is often not available, and cooling towers have to be used; in other cases the financial conditions may be such that a cheaper and therefore less efficient plant is the economical one to adopt. In these cases, allowances can readily be made for the special circumstances of the case. None of the stations described possess all the advantages, but when their disadvantages are allowed for, one, if not two, of the plants come very close to the attainable as thus defined.

Provided all the conditions are similar, that is, provided that the size of unit in each case bears the same ratio to the average load, the efficiency of the station will depend on the size of the unit of generating plant. The basis of the table is therefore the efficiency of the engine and generator and its variation with size. The term engine

ELECTRIC RAILWAY ENGINEERING

includes either reciprocating engine or turbine, and no limitations are imposed in the choice of type, but it is assumed that the engine is the most efficient of its type, and is working at its most economical point, and at the most economical vacuum. The sizes we have selected range from 10,000 down to 500 kilowatts, and in Table XL. the efficiencies are the combined efficiencies of the engine and generator, and represent the best which have been yet attained. The steam pressure selected is 165 lbs. per square inch, and superheat 300 degrees F.

TABLE XL.

Table of Thermal Efficiency of Engine and Generator and Overall Efficiency of Complete Plant on Steady Load.

Economical Rating of Engine and Generator (Kilowatts.)	Nett Energy supplied to Engine per Kilowatt Hour Output (B.T.U.)	Thermal Efficiency of Combined Set.	Total Energy in Fuel burned per Kilowatt Hour Output. (B.T.U.)	Overall Efficiency.
10,000	15,000	0.229	20,600	0.167
5,000	15,320	0.224	21,100	0.163
2,500	15,900	0.216	21,850	0.157
1,250	16,820	0.204	23,100	0.149
1,000	17,270	0.199	23,700	0.145
750	17,970	0.192	24,510	0.140
500	18,930	0.181	26,150	0.131

The figures given in the second column are nett amounts, and do not take into account the energy required for air and circulating pumps, or losses in condenser. After allowing for these, and for losses in radiation from piping, boiler, and economisers, and for the energy supplied to the chimney to produce a draught, we obtain the figures in the fourth column, being the total energy in the fuel. We have now the energy to be provided by the fuel per kilowatt hour under the best conditions and for steady load. In order to obtain the efficiencies of the power plant under service conditions, we take the above table as a basis. We have first to allow for a fluctuation in the load, where, although the output in a given time may be the same as for steady load, the load may have fluctuated between wide limits: next, allowance has to be made for variation in the load, as a result of which the plant is working part of the time at a less efficient part of its range. The losses suffered depend upon the nature of the load curve, and in the following it is assumed that the minimum load can be supplied economically from the unit, and that the new load capacity is drawn upon before an additional unit is put in parallel. A further, and by far the greater, source of loss which follows from the variation in the load, is due to the necessity of keeping up the fires and boilers in readiness for the maximum load. The coal consumed may amount to as much as 6 lbs. per square foot of furnace per hour, the energy being dissipated by radiation from boilers, and piping, and engines, which must be kept in a state of readiness. All these losses are taken into account in Table XLI., the values being based on our general experience and specific tests and observations. The values are plotted in terms of the size of unit and the load factor. By load factor in this case is meant the "daily" load factor obtained from the daily load curve as distinct from the

THE ELECTRICAL POWER GENERATING PLANT

annual load factor, as it is upon this that the efficiency or otherwise of the working depends.

TABLE XII.

Table of Overall Efficiencies of Steam Plants under Service Conditions.

Economic Rating of Unit of Generating Plant in Power Station in Kilowatts

Daily Load Factor, per cent.	10,000	5,000	2,500	1,250	1,000	750	500
Thermal Efficiency of Plant, being Ratio of Output of Generating Plant to the Input into the Furnaces.							
100	0.158	0.155	0.150	0.141	0.138	0.133	0.126
90	0.151	0.147	0.142	0.135	0.132	0.127	0.118
80	0.144	0.141	0.135	0.128	0.125	0.121	0.113
70	0.136	0.133	0.128	0.121	0.118	0.115	0.108
60	0.127	0.124	0.120	0.113	0.110	0.106	0.101
50	0.116	0.114	0.110	0.104	0.102	0.098	0.093
40	0.104	0.101	0.098	0.093	0.090	0.087	0.082
30	0.089	0.087	0.084	0.079	0.078	0.075	0.071
20	0.071	0.067	0.065	0.061	0.060	0.057	0.054
10	0.043	0.041	0.039	0.036	0.035	0.034	0.032

The values given are such as the station engineer should obtain provided he has all the advantages assumed. If any specific advantage, such, for instance, as superheat, is absent, or if he is placed so that the water supply for condensing purposes is limited, or if the water has to be lifted a considerable height, the value of such deficiency can be readily calculated, and, after applying the correction to the values given in the table corresponding to the load factor and size of unit, the result can then be applied to gauge the actual performance of the plant.

Chapter VI

THE HIGH TENSION TRANSMISSION SYSTEM

IN the last chapter we traced the energy from the fuel up to the outgoing mains from the generating station. Up to that point neither the capital costs nor the generating costs are appreciably different whether continuous-current or alternating-current energy is supplied, nor will the voltage of the supply affect the result to any considerable extent.

But we now come to a link in the system where the cost is a function of the form of electrical energy and of the voltage at which it is supplied. In the most extensive and approved modern plants, the electrical energy is delivered from the generating station in the form of three-phase high tension currents, and is transmitted in this form to sub-stations, where by means of suitable converting plant, it is transformed into continuous current. This continuous current is supplied to the conducting rails, or to the overhead trolley line, and thence to the motors on the cars or trains. Where the area over which the energy is to be transmitted is not extensive, it may often be preferable to supply continuous current direct from the generating station and thus avoid the necessity for sub-stations. There are also a few plants where high tension continuous current is supplied from the generating station. During the last couple of years, a great deal of attention and study has also been given to single-phase systems of traction, which permit of transmitting at high tension direct to the car or train, on which is carried an equipment of transforming devices and alternating-current commutator motors. In a related system, the train receives high tension alternating current, which is transformed by means of a motor-generator carried on the train, into low tension continuous-current, and is distributed in this form to the motors. Polyphase motors are used on the car or train on quite a number of roads, and for certain cases this system is excellent.

We shall work out the general case of electric traction on the basis of the first of the above-named systems, since this system has come into very extensive and successful use, and, so far as it is displaced by one or other of the alternative systems, this displacement will occur very gradually, so that for several years, at any rate, a large amount of work will be done by the three-phase continuous-current system.

In cities, and wherever the local conditions or regulations require it, the three-phase high tension transmission system is installed with underground cables. A pressure of 11,000 volts between cores has so frequently been employed that we may, for our present purpose, take it as standard. A higher voltage would, at the present state of development in cable manufacture, rarely be economical, since, as we shall see, even at 11,000 volts, the cost, including installation, is from three to twenty

THE HIGH TENSION TRANSMISSION SYSTEM

times the cost of the contained copper according to the cross-section per core. This multiplier rises rapidly with the voltage. In special cases a lower voltage is more economical, but for all extensive systems we may take 11,000 volts as the basis, at any rate for preliminary estimates. As the neutral points of the armature windings of the high tension generators are grounded at the generating stations, the pressure from any core to earth is $\frac{11,000}{\sqrt{3}} = 6,350$ volts.

Estimation of the Cost of High Tension Cables.

The data given by cable manufacturers in their catalogues, while often very extensive, are rarely in the form most useful to the engineer in designing projects. He must, of course, before the project is completed, have recourse to precise estimates from the cable manufacturers, but prior to that stage he is more especially concerned with the relative costs of complete cables for different voltages. These are, for his purpose, most conveniently expressed in terms of the weight of the copper in the cable, or, more precisely, it is convenient for him to figure on a cost in pounds sterling *per metric ton of contained copper*. These data, together with some details of construction, guarantees, etc., suffices for obtaining a rough estimate of the percentage of the total cost which will be required for the cables. This is all that is required up to the later stages of the designing of an installation. This small amount of data he should, however, have at hand in as compact a form as practicable.

The following brief descriptive specification may be taken as representative of the most generally employed three-phase cables.

Specification.—Three cores of stranded copper conductors, symmetrically disposed with relation to one another, and individually insulated with paper, or other insulation, are spirally assembled together, the pitch of the spiral varying chiefly as a function of the diameter per core. The three cores thus assembled together, are covered with paper or other insulation of suitable thickness.¹ An external covering of lead is then applied, and this in turn is often protected by an armouring, frequently consisting of two layers of steel tape.¹ Sometimes the steel or iron covering is, in its turn, protected by a final covering of tough jute or other suitable material.

Such a cable, when for 11,000 volts, is generally guaranteed to withstand for 1 hour, the application of an effective alternating current voltage of three times the normal voltage when tested at the manufacturer's works, and a further test, with at least double the normal voltage, when finally installed. This test is made between each pair of cores, and from each core to lead.

Recently there has appeared a new type of cable insulated with varnished cambrie. The construction of the cable is as follows:—Specially prepared cotton fabric is coated on both sides with multiple films of insulating varnish. The coated cloth, cut into strips, is applied to the copper core with films of special non-drying, viscous and adhesive compound between the copper and the taping.

The result is a flexible and homogeneous insulating wall of great dielectric strength. This insulation, unlike paper, does not absorb moisture, and it is therefore unnecessary to seal the ends. It is stated that leaded varnished-cambrie cable installed in 1898 on 11,000 volts circuits in connection with overhead transmission lines, exposed to lightning discharge, is still in use without failure or deterioration.

¹ The Engineering Standards Committee's specifications for thicknesses of dielectric and lead sheathing and armouring are given on pp. 162 to 164.

ELECTRIC RAILWAY ENGINEERING

The prices of cable vary chiefly with the normal voltage and with the cross section per core. A further but less important variation in price is introduced by the particular specification as regards the application of armouring or other covering over the lead. The chief components of the cost are, however, represented by the copper, the insulation, the lead, and the installation of the cable. This last item, the installation, tends to partly offset variations with respect to whether armouring and further outer coverings are or are not used. For an armoured cable will require less expensive further provisions than in the case of a bare lead cable. Of course the cost of installing varies greatly. The prices which will be given in subsequent tables may be taken as applying to cables installed in the tunnels of underground electric railways, and in other cases in subways especially provided for the reception of cables, and will not cover any part of the cost of construction of such subways, or of the cost of opening up the streets when other locations are necessary.

With these premises we may take the prices given in Table XLII. as representative, though in cases where competition is exceedingly keen, the price for large quantities may be as much as 20 per cent. lower. Such variations will in no way invalidate the general engineering problem as set forth in this chapter.

The cost of copper on which Table XLII. is based, is taken at £100 per ton. This is the cost of the copper core as stranded, including charges due to wire drawing and stranding. O'Gorman in a paper entitled "Insulation on Cables,"¹ allocates this £100 as follows:—

"G.M.B. copper in the market, £77; cost of wire drawing, £8; stranding, £5; shop charges and administration, £10 per ton."

The current market price for copper is a few pounds lower than £77, so that £100 per ton for the copper cores is rather high. This, however, will cover market fluctuations, and moreover, if more accurate estimates are desired, it is easy to convert costs which are based on a decimal figure, as £100. The results set forth in Table XLII. have been plotted in Figs. 122 and 123, the former giving the cost of complete cable in pounds per ton of copper contained in the three cores, and the latter showing the ratio of the cost of complete cable to the cost of contained copper at £100 per ton for various voltages and cross sections of core.

In the paper by O'Gorman referred to above, the following data as to the cost of insulation and lead sheathing are given:—

"Copper is taken at £100 a ton (or 11*d.* per pound), a price which is rather too high. This is to cover market fluctuations. I justify its use because the deductions and curves which follow are only comparative, and the effect on the total price of the various insulation thicknesses outweighs the price of copper on both small and large sizes. For example, between 15,000 kilowatts and 30,000 kilowatts the price of cable is nearly constant, although the copper varies from 0.53 sq. ins. to 1.5 sq. ins. Another reason for taking a high price for copper is that the labour of handling and jointing will depend on the weight of the cable even though the radial thickness of insulation may go down. Lastly, the decimal figure £100 is easy to correct if a more accurate estimate is available.

"Insulation is taken at £50 per ton. This price is too low for rubber cables,

¹ "Journal of the Institution of Electrical Engineers," Vol. XXX., p. 608 (March 7th, 1901).

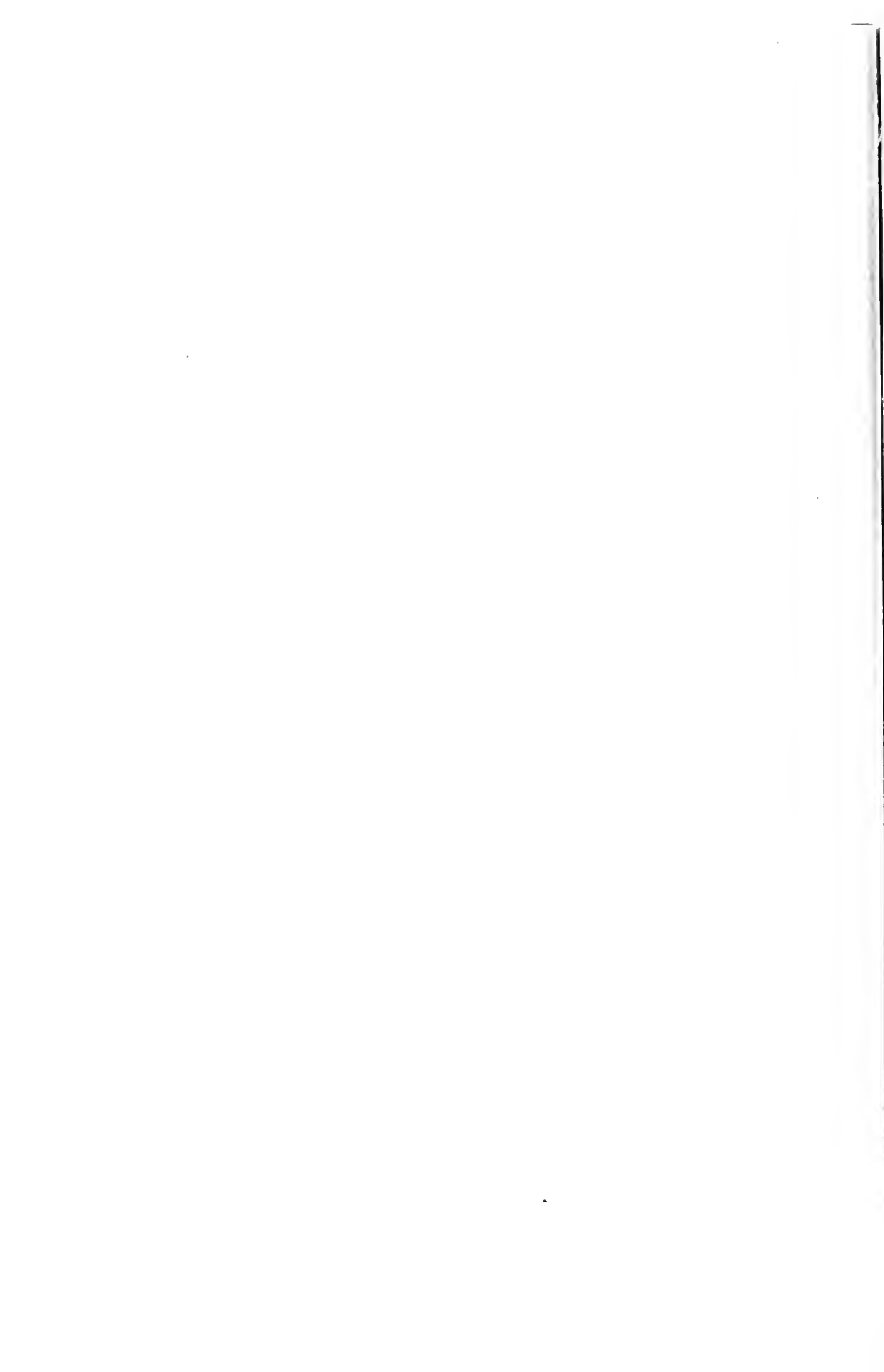

THE HIGH TENSION TRANSMISSION SYSTEM

but as it is well known that the cost of fibre, together with its lead, is of the same order as rubber, it will follow that the general trend of the curves holds for rubber also, only the maxima and minima will be more marked for any class of insulation dearer than I have selected unless the disruptive strength is correspondingly greater. Paper, £35 per ton; impregnating oil, £7; labour, £10; administration, etc., £19.

“Lead was taken at £25 a ton to allow for the labour of lead covering, which is high. A thickness of 0.125 ins. was taken in all cases. This thickness is rather small for large cables, which sometimes take 0.15 or 0.18 ins. If this increase of lead had been allowed for, the rate at which the cost of cable

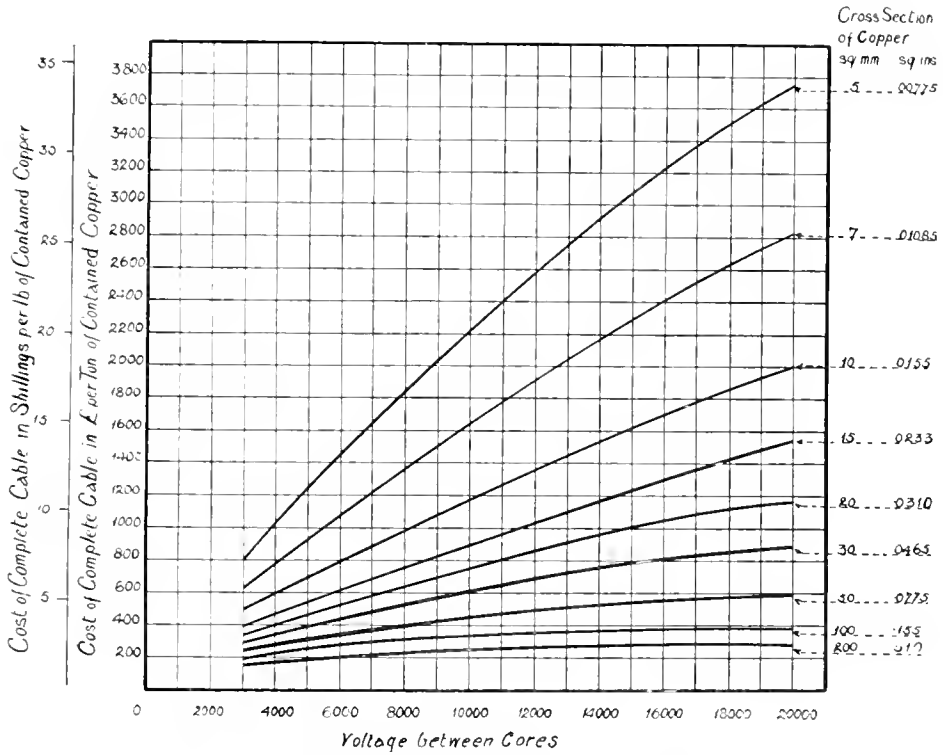

Fig. 122. COSTS OF HIGH-TENSION THREE-CORE CABLES.

increases with increase of output would have been still further diminished within practical limits of copper section, but the character of the curves¹ would not be altered, only accentuated. Best Spanish lead, £15 per ton; labour, £3; administration, £6 a ton.’

The results of Table XLII, and of the curves of Fig. 123 bring out very clearly the fact that the cost of copper in cables, when for high tension work, is but a very small percentage of the total cost of the cables.

On the basis of these data the curves in Fig. 124 have been prepared. These curves show that, while in regions like the western districts of America,

¹ The curves referred to are those published in the paper from which this extract is made. They are for H.T. cables built up on O’Gorman’s principle of grading the dielectric, and are of a similar nature to the curves given in Fig. 121.

ELECTRIC RAILWAY ENGINEERING

it is of distinct advantage to use extremely high potentials for overhead lines with bare conductors, much lower pressures will give the most economical results

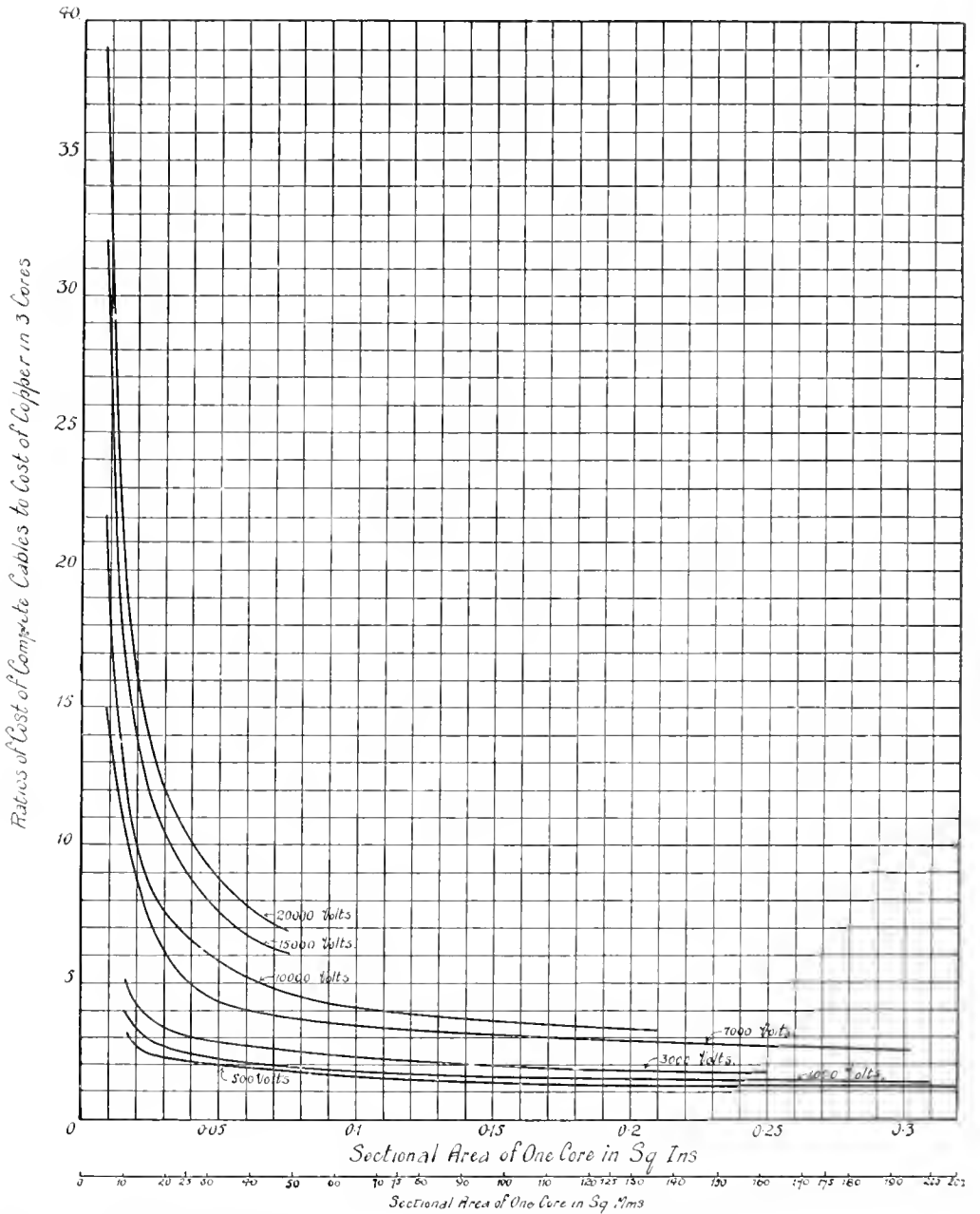
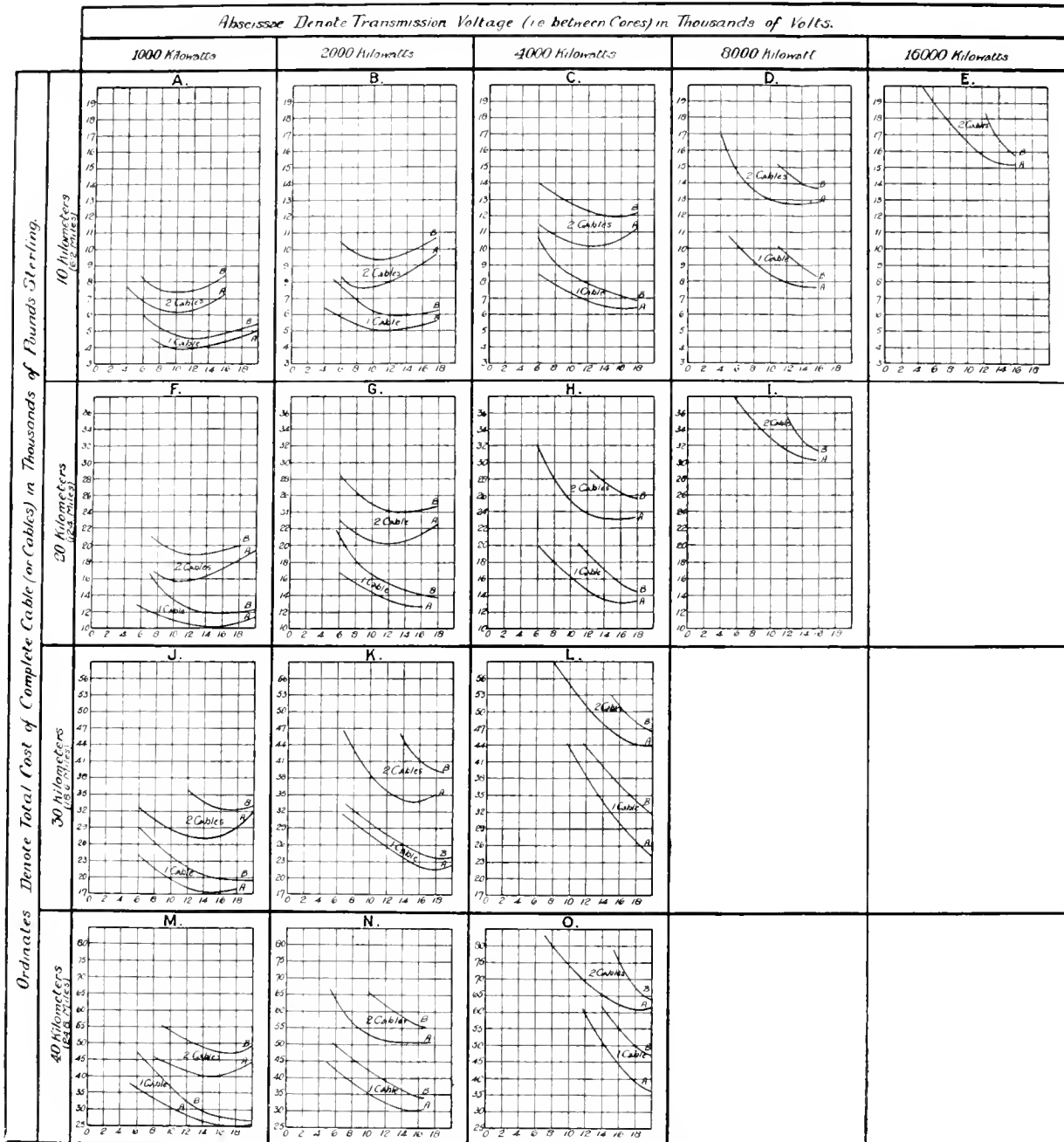

Fig. 123. CURVES SHOWING THE RATIO OF THE COST OF THREE-CORE CABLES COMPLETE, TO THE COST OF COPPER CONTAINED IN THE THREE CORES FOR 500 TO 20,000 VOLTS BETWEEN CORES.

where the regulations of the authorities require the use of underground cables. The curves show the most economical voltage for every case, when considered from the standpoint of the cost of the transmission cables alone. But since the cost

Abscissae Denote Transmission Voltage (ie between Cores) in Thousands of Volts.



Curves Marked A are for Power Factor = 1.0
B = 0.8

Fig. 124. COSTS OF CABLES FOR TRANSMISSION LINES, FOR TRANSMITTING 1,000 TO 16,000 K.W. TO A DISTANCE OF 10 TO 40 KILOMETRES AT POWER FACTORS OF 1.0 AND 0.8.

THE HIGH TENSION TRANSMISSION SYSTEM

of the cables, as revealed by these curves, generally increases but slowly as the voltage is lowered, the increased cost by the use of a considerably lower voltage will often be offset by the slightly lower cost of the generating and transforming apparatus and the less liability to breakdown, owing to the greater factors of safety employed in lower voltage plant.

The curves of Fig. 121 show that a somewhat lower power factor makes but little difference in the cost of the cables. These two curve sheets show results for a case where all the energy is transmitted by a single three-core cable, which would not leave any reserve in the case of a breakdown, and also results for the case of two three-core cables being used, half the energy being transmitted over each cable. This latter is the more usual case in spite of the greater cost; in fact, the use of a single cable would afford altogether insufficient reliability. With the exception of the groups of curves E and I, all the other groups of curves in Fig. 121 are based on the employment of two independent three-core cables, each carrying normally one-half the total energy. In the case of the temporary breakdown of one of these cables, it is generally customary to slightly overload the other cable, and to get along with as small a load as practicable until the damaged cable is repaired. Of course, in very important installations, more than two independent cables are used, two sufficing to carry the normal load continuously.

The curves are self-explanatory. Ten per cent. line loss has been employed in the calculations; but fairly accurate results for other values of line loss can be deduced from the curves without much extra calculation. Where sub-stations employing rotary converters are supplied over the high tension cables, five per cent. line loss, or even less, is desirable, otherwise the regulation will be very unsatisfactory.

In the curves of Fig. 124, it will be noted that at a certain voltage in each case, the cost of the cables reaches a minimum value. At voltages higher than this, the cost of the insulation preponderates, and at lower voltages the cost of the copper, rendering the complete cable more expensive at pressures higher or lower than that for minimum cost. The voltage at which minimum cost occurs, is higher the greater the power transmitted, or the greater the distance to which it is transmitted, and the lower the power factor. It is also higher in the case of a single cable transmitting the whole of the power than for two cables each carrying half the power.

In Figs. 125, 126, 127, and 128, the minimum cost of cables has been plotted as a function of the power transmitted. Figs. 125 and 126 are both for unity power factor, but using one cable in Fig. 125 and two cables in Fig. 126. Figs. 127 and 128 are both for a power factor of 0.8, and using one cable in Fig. 127 and two cables in Fig. 128.

In each case there are shown curves for distances of 10, 20, 30, and 40 kilometres (6.2, 12.4, 18.6, and 24.8 miles). In all these curves the cost which occurs at the most economical voltage has been employed, this voltage ranging from 9,000 to 18,000 in the cases considered, as will be seen from Fig. 124. These curves bring out very clearly the fact that the cost of cables for transmitting power at high pressures is by no means proportional to, although it increases with, the power transmitted and the distance of transmission. This is because the cost of the copper constitutes only a comparatively small proportion of the total cost, the insulation cost being several times that of the copper. This has already been pointed out in connection with Table XLII. and in the curves of Fig. 123, where the ratio of cost of complete cable to cost of contained copper has been tabulated and plotted.

In Table XLII. the cross sections of the conductors may appear to be very miscellaneous and without much consecutive uniformity. This is due to the fact that

Fig. 125.

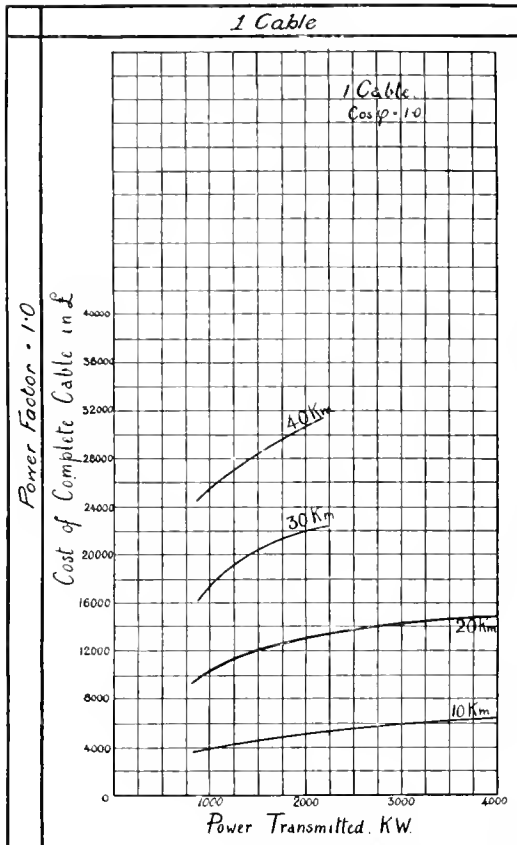

Fig. 126.

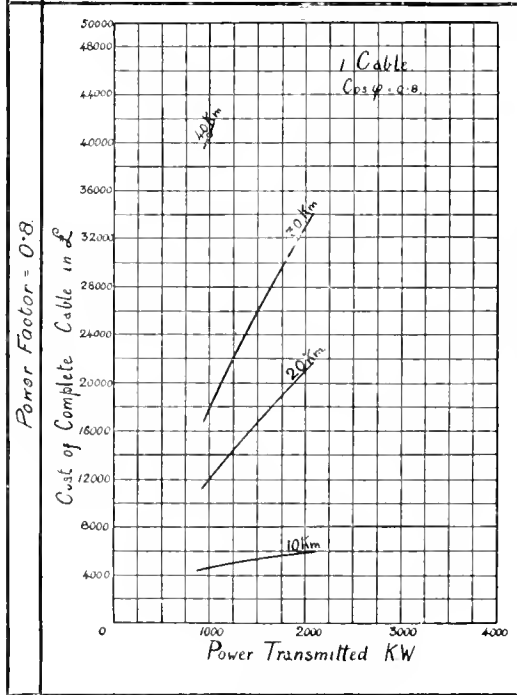
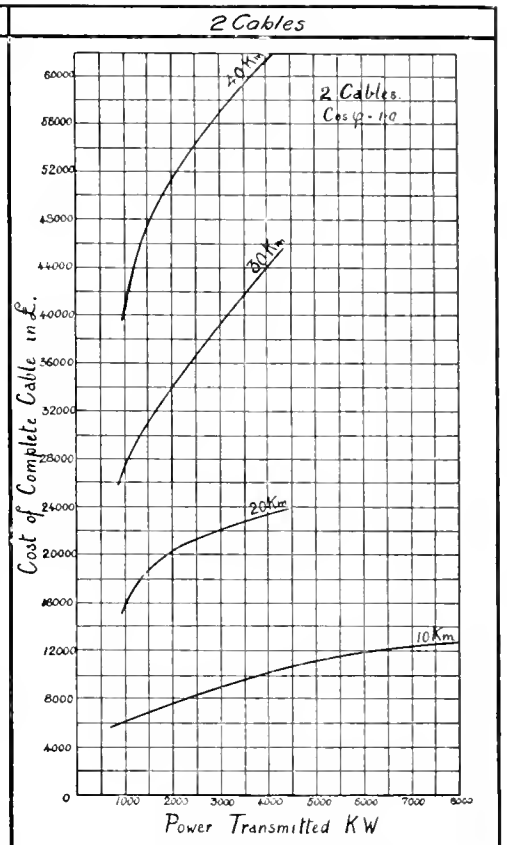
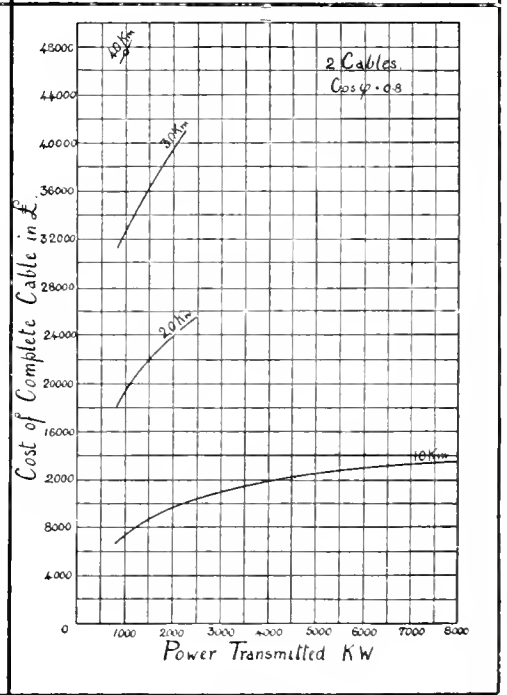

Fig. 128.



Figs. 125, 126, 127, and 128. CURVES SHOWING MINIMUM COSTS OF CABLES FOR TRANSMITTING 1,000 TO 8,000 K.W. TO A DISTANCE OF 10 TO 40 KILOMETRES. See Fig. 124.

THE HIGH TENSION TRANSMISSION SYSTEM

the data necessary for the compilation of this table, were deduced from the lists of various British and Continental manufacturers, whose cross sections usually conform to some number of strands of certain wire gauges which do not give even figures or other uniformity in their cross sections.

It would be possible with the data already arranged in Table XLII. to compile another similar table with a corresponding set of data, but for cross sections of cable cores increasing regularly and by some fixed increment, for instance, starting with a minimum cross section of, say, 25 sq. mm., and increasing this by 25 sq. mm. each time, or a similar even section and increment in square inches. Such a table would be desirable, but as its preparation would involve a large amount of detail work, we have not time to prepare it for the present volume. While mentioning this matter of conductor cross sections, we would draw attention to the Engineering Standards Committee's recommendations. In their report No. 7, designated 'British Standard Tables of Copper Conductors and Thicknesses of Dielectric,' they give a table for large sizes of stranded conductors for electric supply, in which the smallest cross section is 0.025 sq. in., increasing by regular increments of 0.025 sq. in. in the smaller of these sizes, 0.05 sq. in. in the intermediate sizes, and 0.1 sq. in. in the largest sizes. This gives a scale of cross sections of some even number of thousandths of a square inch, increasing by a fixed number of thousandths of a square inch.

Table XLIII. is from the above-mentioned report:—

TABLE XLIII.

British Standard Sizes of Stranded Conductors for Electric Supply.

Approximate Weight per Statute Mile in 100 Lbs.	Area of Conductors in Square Inches.	Number and Diameter in Inches of Strands.
5	0.025	7.068
10	0.050	7.095
10	0.050	19.058
16	0.075	19.072
21	0.100	19.082
26	0.125	19.092
32	0.150	19.101
31	0.150	37.072
41	0.200	37.082
51	0.250	37.092
61	0.300	37.101
73	0.350	37.110
84	0.400	37.118
84	0.400	61.092
95	0.450	61.098
101	0.500	61.101
116	0.550	61.108
121	0.600	61.110
138	0.650	61.118
142	0.700	91.098
151	0.750	91.101
160	0.800	91.104
179	0.900	91.110
207	1.000	91.118
211	1.000	127.101

For cables designated "intermediate sizes" (of cross sections from 0.025 to 0.25 sq. in.), and for those designated "small sizes" (cross sections up to 0.025 sq. in.), the Engineering Standards Committee have adhered to three, seven, nineteen, or

ELECTRIC RAILWAY ENGINEERING

thirty-seven strands of some S.W.G. wire, increasing the number of strands with the cross section.

Temperature Rise in Cables.

The permissible current density and consequent temperature rise of the cable is affected by the method of laying and armouring.

The surroundings of the cable, as regards whether it is laid in conduits or on brackets, with its exterior free to the circulation of the air, also affect its heat-radiating properties, and thus also the permissible current density.

There is a great scarcity of published information regarding the heating of cables under working conditions. The problem must be affected largely by the method of laying the cable, whether in air on racks, or in conduits in the earth; in the latter case, the depth below the surface of the earth, and the nature and conductivity of the soil, will also have a bearing on the heating. Some results by L. A. Ferguson¹ on a few particular cables are given later on, but there is a wide field open for investigation as to how the heating of cables is affected by each of the considerations enumerated above for different classes of cable of various sizes and voltages. Before any standard current densities were recommended, it was general practice to allow a current density of about 1,000 amperes per square inch, regardless of the type of cable and method of laying. Tables XLIV. and XLV. give the maximum current densities allowable for copper wires employed in cables, as defined by the Rules of the Institution of Electrical Engineers (Great Britain), and by the German Society of Electricians (the latter are stated for voltages above 1,000 volts).

TABLE XLIV.

Maximum Permissible Current in Copper Conductors according to the Rules of the Institution of Electrical Engineers.

Size S.W.G.	Section in Square Inches.	Permissible Current for Situations where the External Temperature is above 100° F.	Corresponding Current Density.	Permissible Current where External Temperature is considerably lower than 100° F.	Corresponding Current Density.
18 or 62/38 or 97/40	·00181	3·1	1710	4·2	2320
3/22	·00185	3·3	1780	4·4	2380
17 or 130/40	·00246	4·0	1625	5·4	2200
3/20	·00306	4·8	1570	6·6	2160
16 or 110/38 or 172/40	·00323	4·9	1515	6·8	2100
15	·00409	5·9	1440	8·2	2000
7/22	·00431	6·2	1430	8·7	2020
14 or 172/38 or 7/21½	·00502	7·0	1390	9·8	1950
3/18	·00544	7·5	1380	11·0	2020
7/20	·00715	9·3	1300	13·0	1820
7/18	·01270	14·0	1160	21·0	1650
19/20	·01940	20·0	1030	30·0	1550
7/16	·02260	23·0	1020	34·0	1500
19/18	·03440	31·0	900	48·0	1395
7/14	·03520	32·0	908	49·0	1390
19/16	·06130	49·0	800	77·0	1255
19/14	·09550	70·0	732	110·0	1150
37/16	·11900	83·0	695	130·0	1090
19/12	·16100	100·0	620	170·0	1055
37/14	·18600	120·0	645	190·0	1020
61/15	·25000	150·0	600	240·0	960
61/14	·30600	170·0	555	290·0	948
37/12	·31300	180·0	575	300·0	958
61/12	·51600	260·0	504	450·0	873
91/12	·77000	350·0	455	620·0	805
91/11	·98100	420·0	428	740·0	754

¹ Paper read before Section E of the St. Louis International Electrical Congress of 1904 ("Transactions," Vol. II., p. 666); also *Electrician*, Vol. LIV., p. 964 (March 31st, 1905).

THE HIGH TENSION TRANSMISSION SYSTEM

TABLE XLV.

Current Densities in Copper Wires Employed in Cables for 1,000 Volts and over, according to the Rules of the German Society of Electricians.

Cross Section of Conductor.		Working Current.	Current Density.	
Sq. mm.	Sq. ins.	Amperes.	Amperes per sq. cm.	Amperes per sq. in.
1.5	0.0023	6	400	2580
2.5	0.0039	10	400	2580
4	0.0062	15	375	2420
6	0.0093	20	333	2150
10	0.0155	30	300	1930
16	0.0248	40	250	1610
25	0.0388	60	240	1550
35	0.0543	80	228	1470
50	0.0775	100	200	1290
70	0.109	130	185	1190
95	0.147	160	169	1090
120	0.186	200	167	1075
150	0.233	235	157	1010
185	0.287	275	149	960
240	0.373	330	137	884

Several formulæ have been proposed for calculating permissible current densities corresponding to a certain temperature rise. The Verband Deutscher Elektrotechniker¹ and Teichmüller in the "Elektrotechnische Zeitschrift" for November 3rd, 1904, give involved formulæ, taking account of the conductivity of the soil and the insulation on the cable. In Fig. 129 is given a set of curves² showing the relation between cross section of copper and permissible current for temperature rises of 25 degrees Cent. and 5 degrees Cent., calculated according to these formulæ, for cables laid at a depth of 18 ins. in the earth. On the same sheet appear two curves from experimental data for cables in air, which give an interesting comparison with the other curves.

From the curves in Fig. 129 have been plotted those given in Fig. 130, which show current densities for different cross sections.

The National Conduit and Cable Company, who supplied the cables for the Central London Railway, state the following conditions for three-core cables:—

For continuous operation with alternating current, 1,000 amperes per square inch.

For 6 hours an increase of 30 per cent. in current density, and for 3 hours an increase of 50 per cent., is permissible under ordinary conditions, and a greater increase under conditions which give the surrounding air a good circulation round the cables. The above increase of 30 per cent. would cause a rise in temperature of the copper of approximately 55 degrees Cent. (100 degrees F.) in 3 hours.

Temperature Distribution in Cables.

The temperature rise in the lead sheathing or the armoring is much smaller than that of the copper cores. The sheathing on paper-covered cables does not reach

¹ See "Elektrotechnische Zeitschrift," May 7th, 1903.

² For these curves we are indebted to Mr. A. L. Kavanagh. See paper on "Manufacture and Design of Cables" [Institution of Electrical Engineers (Students' Section), 1905].

ELECTRIC RAILWAY ENGINEERING

so high a temperature as on rubber-covered cables, because of the paper being a better heat insulator than rubber.

Fig. 131 gives a good representation of the relative magnitudes of the temperature rise of the conductors and sheathing. This figure we reproduce, as well as Figs. 132 and 133¹, from the paper by L. A. Ferguson read before Section E of the St. Louis

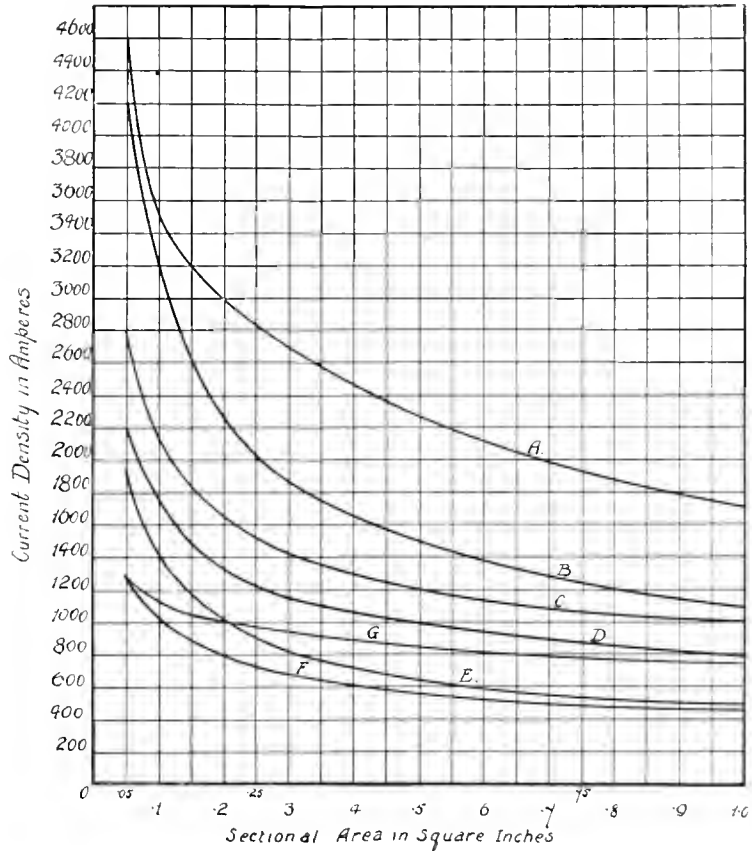

Fig. 129. KAVANAGH'S CURVES OF CURRENT DENSITIES IN CABLES.

- A = Cable 18 ins. underground, 25 degrees Cent. rise.
- B = " " " " " " " " " " " "
- C = Cable in air, 25 degrees Cent. rise.
- D = Cable 18 ins. underground, 50 degrees Cent. rise.
- E = " " " " " " " " " " " "
- F = Cable in air, 50 degrees Cent. rise.
- G = I. E. E. Rules, 10 degrees Cent. rise.

International Electrical Congress of 1904. Some interesting results, showing comparisons between temperature rises of cables in conduits and in the air, are given in this paper, from which we quote the following paragraph:—

“ Nearly all cables for underground work are insulated with either paper or rubber, and are lead-covered. For some purposes, such as the grounded side of street railway circuits or the neutral of Edison three-wire systems, bare copper is satisfactory.

¹ Figs. 132 and 133 are not precise reproductions, but are plotted from the curves as given by Ferguson, but in such groupings as to make them more useful.

THE HIGH TENSION TRANSMISSION SYSTEM

Bare copper should not, however, be installed in the same duct with lead-covered cables. Paper-insulated cable is more generally used than rubber, on account of its lower first cost and also on account of its greater carrying capacity. Rubber cable

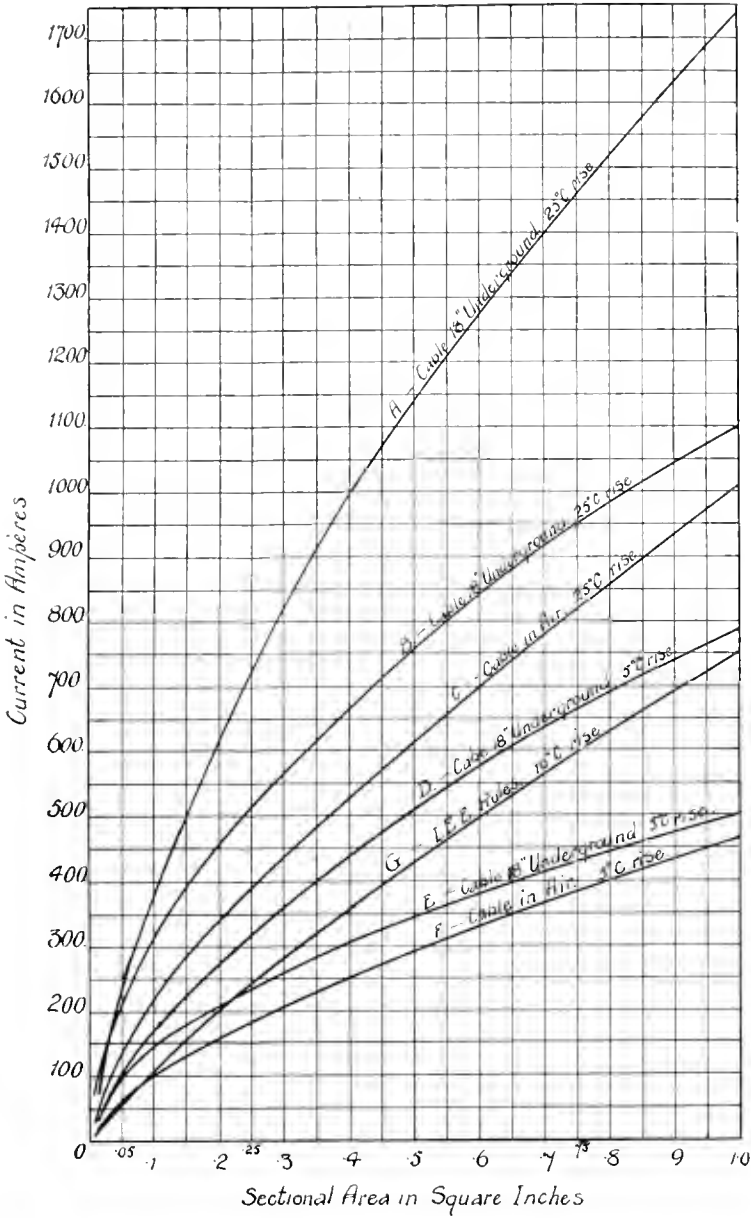

Fig. 130. CURRENT-CARRYING CAPACITY OF BRITISH STANDARD CABLES.

will stand rougher use, and may be more easily handled in extremely cold weather, than paper cable. It is easier to protect the ends of rubber cables than those of paper, and for this reason rubber cable is sometimes used for mains and services on account of the large number of connections necessary for this work. It is not difficult,

ELECTRIC RAILWAY ENGINEERING

however, to safely instal paper-insulated cable for this class of work, and it is much more satisfactory to do this, and thus carry only one kind of cable in stock. Paper-insulated cable is particularly suitable for feeders on account of its high carrying capacity. Within the past two years cable with varnished cambric insulation has been used for high-voltage work inside stations, and to a limited extent for underground work.

“Single-conductor cable is commonly used for low-tension feeders in sizes ranging from 250,000 circular mils. to 1,000,000 circular mils. Considerable saving in feeders may be made by using two-conductor concentric cable, with pressure wires laid up with the outer conductor. Concentric cables for feeders are used mostly in the 1,000,000 circular mil. size. Its carrying capacity is less than that of two-conductor cables of the same size, and the cost is about the same. The saving is made in duct and manhole space, and in the cost of installation.

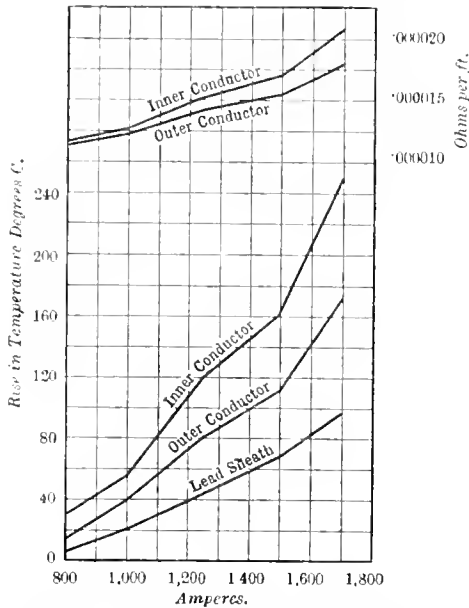

Fig. 131. FERGUSON'S TESTS OF TEMPERATURE DISTRIBUTION IN CABLES.

“Figs. 132 and 133 show the carrying capacity of lead-covered paper-insulated cable in conduit and in air. These tests were made in a laboratory, the conduit

Cable in Conduit

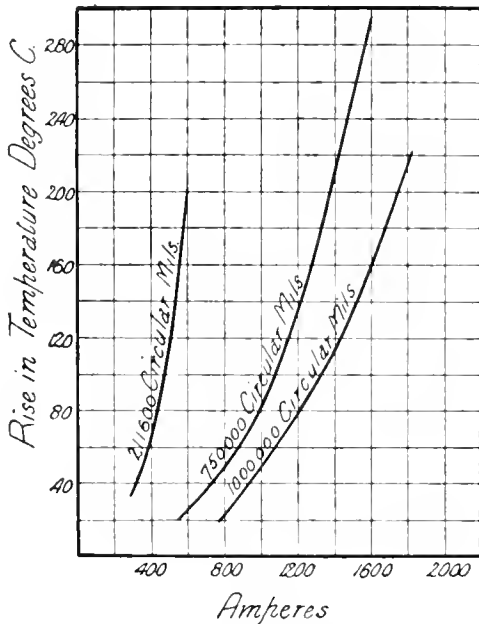

Fig. 132.

Cable in Air

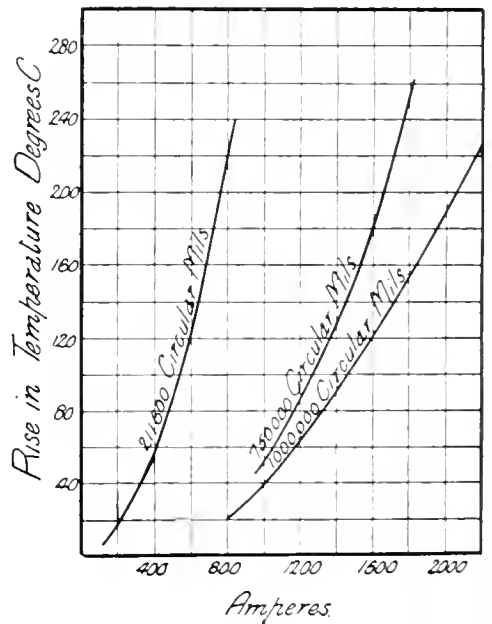

Fig. 133.

Figs. 132, 133. FERGUSON'S CURVES SHOWING TEMPERATURE RISE IN CABLES.

THE HIGH TENSION TRANSMISSION SYSTEM

consisting of a single duct of vitrified clay pipe surrounded with approximately 6 ins. of sand on all sides. The tests on 1,000,000 circular mils. two-conductor concentric cable, were made with the cable in the air. Concentric cable should be made with the inner conductor so much larger than the outer that the average loss in the two conductors will be the same. At maximum load the loss would be more in the inner than the outer conductor, and less in case of light load."

Cable Installation.

For underground work, cables are laid in some form of conduit. The material of the conduit is generally a variety of earthenware. Vitrified clay pipes and ducts are in most common use. Cement-lined iron pipe has been used in some cases. Earthenware conduits may be either of single or multiple duct construction, with either round or square ducts. The square duct is generally preferable on account of the greater ease with which the cables can be drawn in. In L. A. Ferguson's St. Louis Congress paper, referred to above, the question of conduit construction is well considered, and the substance of the conclusions is embodied in the following paragraphs:—

"Various forms of ducts are on the market for underground work, vitrified clay tile being used much more than all other kinds of conduit.

"Multiple duct is furnished in sizes ranging from two to nine ducts, and in lengths ranging up to 6 ft., although the 6-ft. lengths are not made to any great extent, on account of the danger of warping; 3 ft. is the standard size for four and six-duct multiples; nine-duct tile is difficult to handle, and four and six-duct sections are most generally used. There are two objections to the use of multiple duct as compared with single duct: first, between any two cables in one piece of multiple duct there is only one wall; second, it is not possible to break joints as with single-duct conduit. These two things increase the liability of a fire in one duct reaching cables in adjoining ducts. In single-duct construction, there are always two walls between adjacent cables, and all joints are broken, so that there is but very slight possibility of a burn-out in one cable reaching any adjoining cable. Single-duct construction is unquestionably the best, particularly for large companies, where a burn-out on a cable is liable to be severe on account of the large amount of power concentrated at that point.

"The first cost of single and multiple tile is approximately the same. The cost of installing multiple duct should be approximately 15 per cent. less per duct than for single duct. The weight of single-duct tile is about 20 per cent. more per duct foot than for four and six-duct multiples. The lower cost of installing multiple duct is due to the lower freight charges on account of the lesser weight, and also to the smaller cost for labour. It is usually necessary to employ a bricklayer for installing single-duct conduit, and multiple-duct may generally be installed with the better class of labourers.

"A good arrangement of ducts is secured by laying them not more than four wide and as high as necessary to obtain the required number of ducts. These ducts should be separated into two vertical rows where they enter the manhole, the separation being about 8 ins. The separating of the ducts should begin about 5 ft. or 6 ft. back from the manhole. This arrangement gives two vertical rows of cables on each side of the manhole, and leaves them much easier to support and protect than would be the case with three or more vertical rows. With an

ELECTRIC RAILWAY ENGINEERING

arrangement of ducts not more than four wide, no cable can have more than one other duct between it and the surrounding earth, thus permitting good radiation of heat."

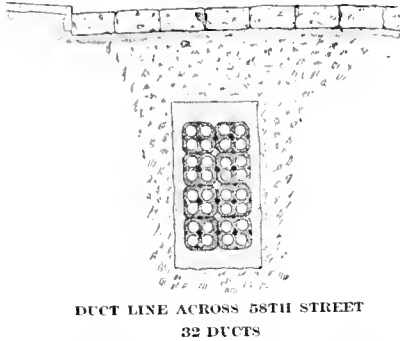

Fig. 134. NEW YORK SUBWAY: ARRANGEMENT OF CABLE DUCTS UNDER STREET.

each comprising thirty-two ducts, have been constructed. These conduits are located on opposite sides of the street. The arrangement of ducts is 8×4 , as shown in Fig. 134. The location and arrangement of ducts along the line of the subway are illustrated in photographs in Figs. 135 and 136, which show respectively a section of ducts on one side of the subway between passenger stations, and a section of ducts and one side of the subway beneath the platform of a passenger station. From City Hall to 96th Street (except through the Park Avenue tunnel) sixty-four ducts are provided on each side of the subway. North of 96th Street, sixty-four ducts are provided for the west-side lines, and an equal number for the east-side lines. Between passenger stations, these ducts help to form the side walls of the subway, and are arranged thirty-two ducts high and two ducts wide as in Fig. 135. Beneath the platforms of passenger stations the arrangement is somewhat varied because of local obstructions, such as pipes, sewers, etc., of which it was necessary to take account in the construction of the stations. The plan shown in Fig. 136 is, however, typical.

"The necessity of passing the cables from the 32×2 arrangement of ducts along the side of the tunnel to 8×8 and 16×4 arrangement of ducts beneath the passenger platforms, involves serious difficulties in the proper support and protection of cables

Cable Work of the New York Subway.

The cable work on the subway of the Interborough Rapid Transit Co. affords an interesting instance of modern methods. The following description is abstracted, by permission, from the Company's publication entitled "The New York Subway: its Construction and Equipment":—

"From the power-house to the subway at 58th Street and Broadway, two lines of conduit, each comprising thirty-

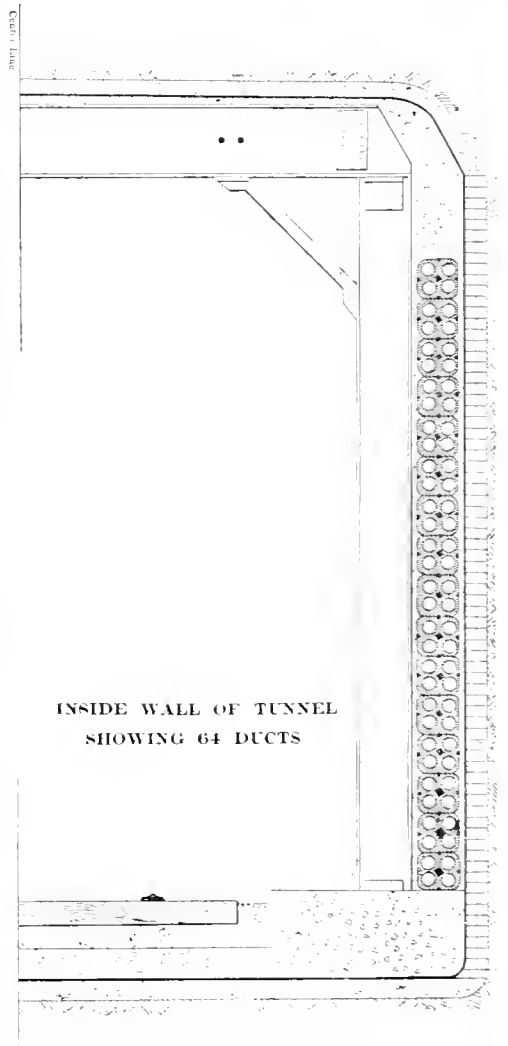

Fig. 135. NEW YORK SUBWAY: LOCATION AND ARRANGEMENT OF CABLE DUCTS INSIDE WALL OF TUNNEL.

THE HIGH TENSION TRANSMISSION SYSTEM

in manholes at the ends of the station platforms. In order to minimise the risk of interruption of service due to possible damage to a considerable number of cables in one of these manholes, resulting from short circuit in a single cable, all cables, except at the joints, are covered with two layers of asbestos, aggregating a full quarter-inch in thickness. This asbestos is specially prepared, and is applied by wrapping the cable with two strips, each 3 ins. in width, the outer strip covering the line of junction between adjacent spirals of the inner strip, the whole when in place being impregnated with a solution of silicate of soda. The joints themselves are covered with two layers of asbestos held in place by steel tape applied spirally. To distribute the strains upon the cables in manholes, radial supports of various curvatures, and made of malleable cast iron, are used. The photograph in Fig. 137 illustrates the arrangement of cables in one of these manholes.

“In order to further diminish the risk of interruption of the service due to failure of power supply, each sub-station south of 96th Street receives its alternating current from the power-house through cables carried on opposite sides of the subway. To protect the lead sheaths of the cables against damage by electrolysis, rubber insulating pieces one-sixth of an inch in thickness are placed between the sheaths and the iron bracket supports in the manholes.

“The cables used for conveying energy from the power-house to the several sub-stations, aggregate approximately 150 miles in length. The cable used for this purpose comprises three stranded copper conductors, each of which contains nineteen wires, and the diameter of the stranded conductor thus formed is 0.40 of an inch.

Paper insulation is employed, and the triple cable is enclosed in a lead sheath $\frac{9}{64}$ of an inch thick. Each conductor is separated from its neighbours and from the lead sheath by insulation of treated paper $\frac{7}{16}$ of an inch in thickness. The outside diameter of the cables is $2\frac{3}{4}$ of an inch, and the weight $8\frac{1}{2}$ lbs. per lineal foot. In the factories the cable as manufactured was cut into lengths corresponding to the distance between manholes, and each length subjected to severe tests, including application to the insulation of an alternating current potential of 30,000 volts for a period of 30 minutes. These cables were installed under the supervision of the Interborough Co.'s engineers, and, after jointing, each complete cable from power-house to sub-station was tested by applying an alternating potential of 30,000 volts for 30 minutes between each conductor and its neighbours, and between each conductor and the lead sheath. The photograph in Fig. 138 illustrates this cable.”

Another method frequently adopted in railway work is to run the feeders along beside the track, supporting them on cast iron brackets, with semicircular channelled lugs fixed on to the walls of the tunnel, or on to wooden stakes driven vertically

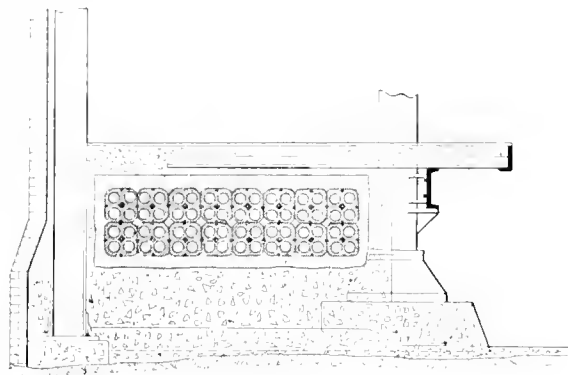

DUCTS UNDER PASSENGER STATION PLATFORM
64 DUCTS
Fig. 136. NEW YORK SUBWAY: ARRANGEMENT OF
CABLE DUCTS UNDER PASSENGER STATION.

ELECTRIC RAILWAY ENGINEERING

in the ground. In this way several cables can be efficiently laid one above the other, and the whole group covered in with a protecting cover of sheet iron.

Examples of this practice are given in the case of the Central London Railway and the London Underground Electric Railways, of which systems we shall now give some particulars.

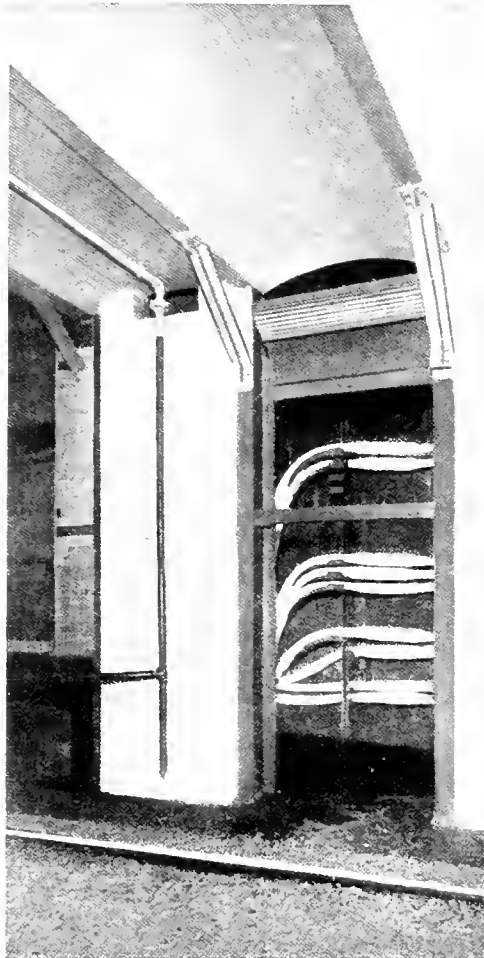

Fig. 137. NEW YORK SUBWAY: ARRANGEMENT OF CABLES IN MANHOLE.

Marble Arch sub-station, one of the cables in each tunnel is discontinued. The other two proceed with the 0.125 sq. in. (80.5 sq. mm.) cross-section to the Post-office sub-station, where they are carried directly to the feeder panels. Here the high tension line terminates.

The following is abstracted from the specification to which the cables were built:—

Each cable consists of three separately insulated conductors, paper-insulated and lead-sheathed. Each conductor is insulated with paper impregnated with resinous oil to a thickness of $\frac{1}{8}$ in. (0.317 cm.), twisted together with a lead of 18 ins. and the whole surrounded by additional impregnated paper of a minimum thickness of $\frac{1}{8}$ in. (0.317 cm.), so that the minimum thickness between cores or

Cable Work of the Central London Railway.

The high tension cables were furnished by the National Conduit and Cable Co. of New York. They are three-core cables, paper-insulated, and were tested at the works to 15,000 R.M.S. volts between the different cores and from cores to earth. The normal working voltage is 5,000 volts between cores.

The 5,000-volt current leaves the power-house by four independent lead-covered three-core cables. From the power-house to Notting Hill Gate each core has a total copper cross-section of 1875 sq. in. (121 sq. mm.). The cables, two in the down tunnel and two in the up tunnel, are laid upon cast-iron brackets at the side of the tunnel, and are protected by curved sheet iron plates throughout the length. The arrangement is shown in Fig. 139.

At Notting Hill Gate sub-station, three 37/16 cables are carried from the three cores of each of the four cables, the joints being made and protected by an ebonite cylinder filled in with paraffin.

From Notting Hill Gate to Marble Arch the cross-section of the core is reduced to 0.125 sq. in. (80.5 sq. mm.). At

THE HIGH TENSION TRANSMISSION SYSTEM

between core and sheath is $\frac{1}{4}$ in. (0.634 cm.). The cable is protected by pure lead sheathing $\frac{1}{8}$ in. thick. Sections through these cables are shown in Fig. 143 (cables Nos. 2 and 3).

The resistance per conductor per 1,000 ft. of finished cable at a temperature of 60 degrees F. was not to exceed 0.0645 ohm for 0.125 sq. in. section of copper and 0.0430 ohm for 0.1875 sq. in. section of copper. The cables were tested with a pressure of 15,000 effective volts alternating, between adjacent conductors and between each conductor and lead covering, at the makers' works. When laid and

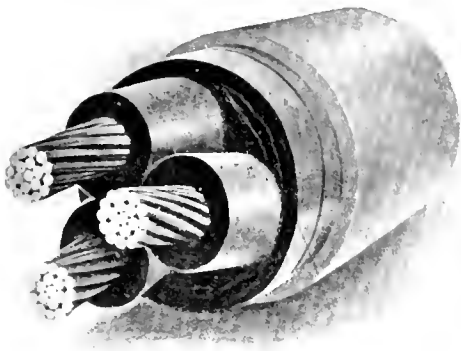

Fig. 138. NEW YORK SUBWAY: CABLE.

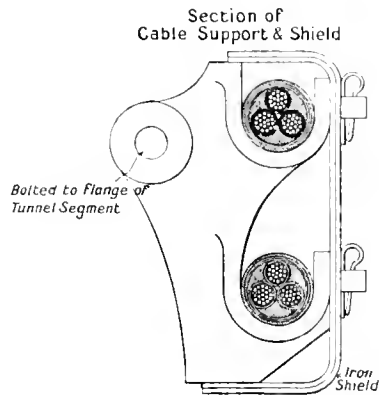

Fig. 139. ARRANGEMENT OF CENTRAL LONDON RAILWAY CABLES.

jointed the cable was subjected to an effective alternating voltage of 10,000 volts at 25 cycles for 1 hour.

The cables were manufactured in lengths wound on the ordinary drums, of convenient diameter for working in the tunnels. The diameter of the tunnels is 11 ft. 6 ins., and the clear height from level of rails 9 ft.

There are no manufacturers' joints in the lengths supplied.

Table XLVI. gives particulars of the cables as laid:—

TABLE XLVI.

Particulars of Central London Railway High Tension Cables.

	Distance between Stations — Yards.	Number of Three-core Cables.	Total Length of Cable — Yards.	Sectional Area.		Number of Strands.	Area of each Strand—Circular Mills.	Overall Diameter.	Resistance of each Core per 1,000 Yards.
				Square Inches.	Circular Mills.				
Generating Station to Notting Hill Gate Sub-station	2530	4	10,120	0.1875	239,000	37	6460	2 $\frac{1}{4}$ "	0.130
Notting Hill Gate Sub-station to Marble Arch Sub-station	3050	4	12,200	0.125	159,200	19	8380	1 $\frac{5}{16}$ "	0.195
Marble Arch Sub-station to Post-office Sub-station	4590	2	9180	0.125	159,200	19	8380	1 $\frac{5}{16}$ "	0.195

ELECTRIC RAILWAY ENGINEERING

At the time of making the insulation tests, the capacity current was measured, with the following results:—

Test pressure	10,000 volts.
Periodicity	25 cycles per second.

Two cables were tested in parallel, *i.e.*, one core from each, connected together and tested to the other four cores connected to sheaths.

Power House switchboard to Notting Hill Gate switchboard	1.9 amperes.
.. .. to Marble Arch switchboard	3.7 ..
.. .. to Post-office switchboard	4.7 ..

In Fig. 143, cables Nos. 2 and 3, are given sections of the two sizes of cables employed. Table XLVII. gives a tabular statement of the capacity per mile between cores, and from cores to lead. These values were deduced from the tests already referred to.

TABLE XLVII.
Dielectric Capacity of Central London Railway Cables.

	Capacity per Mile in Microfarad.
One core and other two cores and sheath	0.38
One core and other two cores	0.32
One core and one other core	0.23

Other data of interest regarding these high tension cables are tabulated below:—

TABLE XLVIII.
Weights and Dimensions of Central London Railway High Tension Cables.

	1.75 Square Inch Cores.	1.25 Square Inch Cores.
Pounds copper per cable per 1,000 ft. length	2140	1425
Pounds insulation per cable 1,000 ft. length	1090	995
Pounds lead per cable per 1,000 ft. length	3870	3480
Pounds weight complete cable per 1,000 ft. length	7100	5900
Pounds weight complete cable per cubic inch	0.166	0.165
Average specific gravity complete cable	4.6	4.6
Total weight of copper in all high tension cables	78.4 tons.	
Total weight of all high tension cables complete	290 ..	
Total length of all high tension cables	19.6 miles.	
Outside diameter	2 $\frac{1}{8}$ ins., 1 $\frac{5}{16}$ ins.	

*Cable Work of the London Underground Electric Railways.
District Railway.*

The contract for cables on this railway was divided between several manufacturers, the British Insulated and Helsby Cables, Ltd., having the largest portion. Each manufacturer had several sections in different parts of the system.

The total length of high tension cable employed on the system is about 207 miles, exclusive of 78 miles laid down for the Great Northern and Brompton, Baker Street and Waterloo, and Charing Cross and Hampstead Railways, and between Lot's Road and Earl's Court, and Earl's Court and Charing Cross.

THE HIGH TENSION TRANSMISSION SYSTEM

The total length of cable supplying high tension current from Lot's Road to all railways fed, will be about 363 miles.

All the cables supplied by the British Insulated and Helsby Cables, Ltd., for high tension current, are three-core, paper-insulated and lead-covered, for a working pressure of 11,000 volts. The cables were supplied in three sizes, particulars of which are given in the following table:—

TABLE XLIX.

Particulars of London Underground Railways High Tension Cables.

	Size of Cable—L.S.G.		
	No. 37.15.	No. 37.14.	No. 37.13.
Sectional area of each conductor, square inch	0.15	0.19	0.25
Maximum resistance of each conductor per 1,000 ft. at 60° F. ohm	0.054	0.044	0.034
Thickness of insulation between conductors	0.4375 in.	0.4375 in.	0.4375 in.
Thickness of insulation between conductors and earth	0.4375 in.	0.4375 in.	0.4375 in.
Thickness of each insulation paper	0.005 in.	0.005 in.	0.005 in.
Thickness of lead covering	0.1875 in.	0.1875 in.	0.1875 in.
Approximate overall diameter of finished cable	2.65 ins.	2.78 ins.	2.94 ins.
Approximate diameter of finished joints	4 ins.	4.2 ins.	4.4 ins.
Approximate maximum insulation resistance per mile, at 60° F. (megohms)	500	500	500

The thickness of the insulation between the conductors, as well as between each conductor and earth, is 0.437 in.

The maximum insulation resistance per mile is 500 megohms at 60 degrees F.

The specification provided that the cables should stand 33,000 volts after being

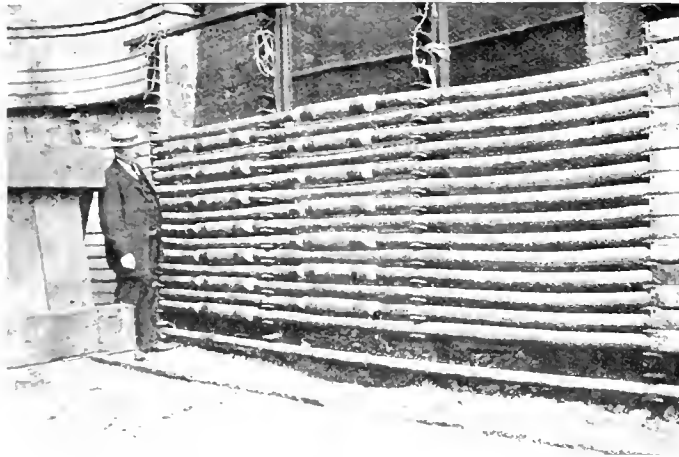

Fig. 140. DISTRICT RAILWAY: CABLES MOUNTED ON WALL, SHOWING JOINTS.

immersed in water for 24 hours, and it is understood that they have withstood 40,000 volts in Works tests.¹

In all, some 200 miles of cable were supplied by the British Insulated and Helsby Cables, Ltd.

¹ See *Light Railway and Tramway Journal*, February 3rd. 1905.

ELECTRIC RAILWAY ENGINEERING

The work of laying or fixing sections of cable was very arduous, as all the tunnel portions had to be laid or drawn into ducts during a working night of $2\frac{3}{4}$ hours, this being the only time during which no trains were running.

The work was carried out in less than 6 months, in spite of late deliveries of material other than the cables themselves.

The work of jointing the cables in the British Insulated and Helsby sections was very heavy, there being in all 1,330 joints. These were completed in an average time of 5 hours per joint. The joints made by the British Insulated and Helsby Cables are insulated with tape boiled in resin oil. Out of 110 miles of cable, 106 miles were laid in 540 hours. The average working week being 19 hours, this period was spread over 6 months. The cables were carried in racks at places where the joints occur, the joints being staggered, as shown in Fig. 140.

The cables supplied by Messrs. Callender's Cable and Construction Co., are all three-core, paper-insulated, and lead-covered. They are intended for a working pressure of 11,000 volts at $33\frac{1}{3}$ periods. The cables were tested at the factory at 33,000 volts between adjacent cores, and between each core and earth. They were also tested with 22,000 volts for 1 hour between earth and conductors when laid. These cables were supplied in two sizes, each size having three cores of 0.15 sq. in. and 0.25 sq. in. respectively.

The weight of the larger cable is about 28 tons per mile, with a capacity of about 0.29 microfarad per mile. The smaller cable weighs 25 tons per mile, and has a capacity of 0.354 microfarad per mile.

These cables are drawn into glazed earthenware pipes of $3\frac{1}{2}$ ins. internal diameter, the pipes being laid in concrete.

The average distance between draw-pits is about 350 ft., with a maximum distance of 570 ft. The following description of the method of making a joint may be interesting¹:—

The lead and insulation of each cable is cut back, and the ends of the three copper cores of each cable are then cut so as to "butt" solid against each other; the cores, however, are cut in such a manner that the joints are stepped. Over the ends of the copper cores are slipped copper ferrules, which are sweated on. These ferrules are then lapped with high insulation

linen tape, and painted with composition. After each joint has been made, three

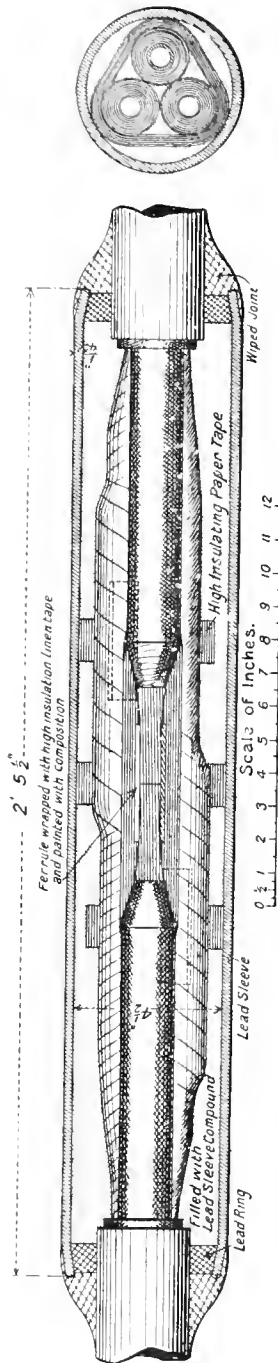

Fig. 141. DISTRICT RAILWAY: SECTION THROUGH HIGH TENSION CABLE-JOINT.

¹ See *Light Railway and Tramway Journal*, February 3rd, 1905.

THE HIGH TENSION TRANSMISSION SYSTEM

rings of high-insulation tape are wrapped around to keep the cores in their proper position. A lead sleeve, which has previously been slipped over the end of one of the cables, is then placed in position, and wiped down on to a lead ring at each end. The sleeve is then filled with special lead-sleeve compound, and the hole



Fig. 142. DISTRICT RAILWAY: MANHOLE IN TRANSMISSION LINE UNDER CONSTRUCTION.

through which the compound has been poured is then sweated solid. A section through a joint is shown in Fig. 141.

Fig. 142 gives a view of a manhole in the transmission line during construction, showing the cable ducts.

Metropolitan Railway.

All the cables for the Metropolitan Railway were supplied and laid by the British Insulated and Helsby Cables, Ltd. The cables have three conductors, are paper-insulated and lead-covered. The lead is protected by insulating material, and the whole is then armoured by round galvanised steel wires of 0.104 in. diameter. The overall diameter of the cable is about 3 inches. All the cables were tested at the works at 33,000 volts, and again at 22,000 volts, or double the working pressure when laid.

ELECTRIC RAILWAY ENGINEERING

In all, there are 9 miles of cable of 0.15 sq. in. cross section ;

..	..	14	..	.	0.20
..	..	24	0.25
..	..	25	0.10

Outside the stations, the cables are laid solid in wooden troughs run in with pitch. At bridges, etc., they are drawn into pipes.

The low tension cables are connected to the rails by low tension rubber insulated cables, which are partly in ducts and partly in troughs.

In Fig. 143 are given drawings of sections through several high tension cables, including the Central London Railway and Metropolitan District Railway cables already described.



Fig. 144. SECTION OF HENLEY'S PATENT LAMINÆ CONDUCTOR THREE-CORE CABLE.

Fig. 144 shows a section through Henley's Patent "Laminæ" Conductor Cable, which is a recent development in three-core cables; the cores are built up of a number of V-shaped copper strips laid up one within the other.

In Tables L., LL., LII., and LIII. are given the Engineering Standards Committee's standard thicknesses of insulation and lead sheathing for three-core and concentric cables, paper-insulated (Tables L. and LI.) and rubber-insulated (Tables LII. and LIII.). These tables are for voltages from 2,200 to 11,000, but we are only concerned here with extra high pressures, *i.e.*, above 5,000 volts. We have inserted these tables exactly as they stand in the committee's report, because there is much useful information in them, and we wish to bring into prominence such work in the direction of standardisation on a rational basis.

TABLE L.

Engineering Standards Committee's Table of Thicknesses of Insulation for Paper-Insulated Concentric Cables for Pressures exceeding 2,200 Volts.

Nominal Area of Conductors.	HIGH PRESSURE CONCENTRIC WORKING PRESSURE.			EXTRA HIGH PRESSURE CONCENTRIC WORKING PRESSURES.								
	2,200 Volts.			3,300 Volts.			6,600 Volts.			11,000 Volts.		
	Dielectric Inner.	Dielectric Earthed Outer.	Lead.	Dielectric Inner.	Dielectric Earthed Outer.	Lead.	Dielectric Inner.	Dielectric Earthed Outer.	Lead.	Dielectric Inner.	Dielectric Earthed Outer.	Lead.
Square Inch.	Inch.	Inch.	Inch.	Inch.	Inch.	Inch.	Inch.	Inch.	Inch.	Inch.	Inch.	Inch.
.025	.12	.08	.08	.15	.09	.09	.25	.10	.10	.35	.12	.12
.050	.12	.08	.09	.15	.09	.10	.23	.10	.11	.35	.12	.13
.075	.12	.08	.09	.15	.09	.10	.23	.10	.12	.35	.12	.14
.100	.13	.09	.10	.16	.10	.10	.24	.11	.12	.36	.12	.14
.125	.13	.09	.10	.16	.10	.11	.24	.11	.13	.36	.12	.14
.150	.13	.09	.11	.16	.11	.11	.24	.12	.13	.36	.12	.15
.200	.13	.09	.11	.16	.11	.12	.24	.12	.13	.36	.12	.15
.250	.14	.10	.12	.17	.11	.13	.25	.12	.14	.37	.12	.16
Test at Works:—10,000 Volts for half-an-hour.			Test at Works:—12,000 Volts for half-an-hour.			Test at Works:—20,000 Volts for half-an-hour.			Test at Works:—30,000 Volts for half-an-hour.			
Test when laid and jointed:—4,000 Volts for half-an-hour.			Test when laid and jointed:—6,000 Volts for half-an-hour.			Test when laid and jointed:—12,000 Volts for half-an-hour.			Test when laid and jointed:—20,000 Volts for half-an-hour.			

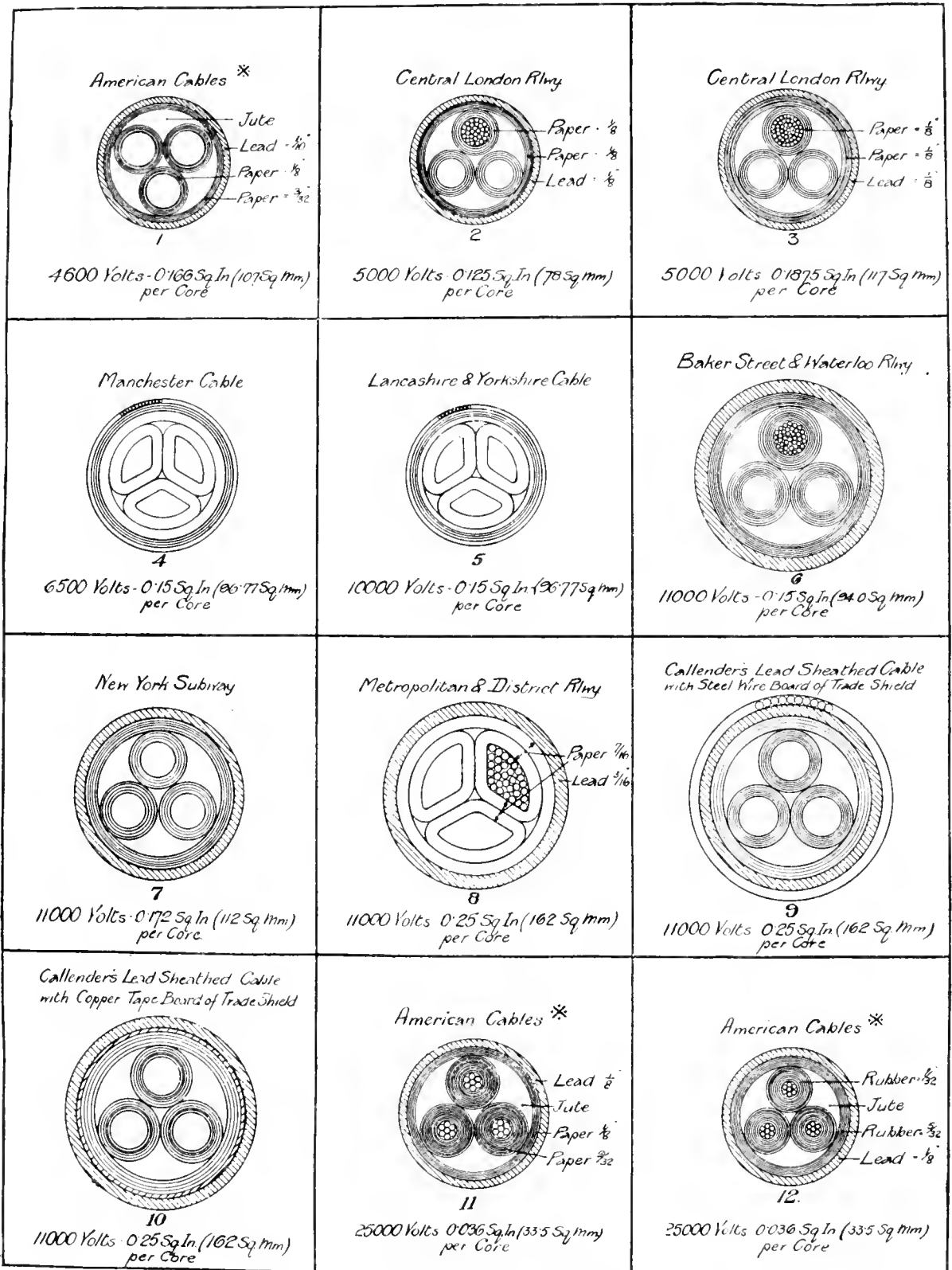

Fig. 143. SECTIONS OF VARIOUS HIGH TENSION CABLES.



THE HIGH TENSION TRANSMISSION SYSTEM

TABLE LI.

Engineering Standards Committee's Table of Thicknesses of Insulation for Paper-Insulated Three-Core Cables for Pressures exceeding 2,200 Volts.

Nominal Area of Conductors.	HIGH PRESSURE THREE-CORE WORKING PRESSURE.						EXTRA HIGH PRESSURE THREE-CORE WORKING PRESSURES.					
	2,200 Volts.			3,300 Volts.			6,000 Volts.			11,000 Volts.		
	Dielectric Between and Outside.	Dielectric Outer on Star Winding with Centre Earthed.	Lead.	Dielectric Between and Outside.	Dielectric Outer on Star Winding with Centre Earthed.	Lead.	Dielectric Between and Outside.	Dielectric Outer on Star Winding with Centre Earthed.	Lead.	Dielectric Between and Outside.	Dielectric Outer on Star Winding with Centre Earthed.	Lead.
Square Inch.	Inch.	Inch.	Inch.	Inch.	Inch.	Inch.	Inch.	Inch.	Inch.	Inch.	Inch.	Inch.
.025	.13	.10	.08	.15	.12	.09	.23	.17	.10	.35	.23	.12
.050	.13	.10	.09	.15	.12	.10	.23	.17	.11	.35	.23	.13
.075	.13	.10	.10	.15	.12	.10	.23	.17	.12	.35	.23	.13
.100	.14	.11	.11	.16	.13	.11	.21	.18	.12	.36	.24	.14
.125	.14	.11	.11	.16	.13	.12	.24	.18	.13	.36	.24	.14
.150	.14	.11	.12	.16	.13	.12	.24	.18	.13	.36	.24	.15
.200	.14	.11	.13	.16	.13	.13	.24	.18	.14	.36	.24	.16
.250	.15	.12	.13	.17	.14	.14	.25	.19	.15	.37	.25	.17

Test at Works:—10,000 Volts for half-an-hour.
 Test when laid and jointed:—4,000 Volts for half-an-hour.

Test at Works:—12,000 Volts for half-an-hour.
 Test when laid and jointed:—6,000 Volts for half-an-hour.

Test at Works:—20,000 Volts for half-an-hour.
 Test when laid and jointed:—12,000 Volts for half-an-hour.

Test at Works:—30,000 Volts for half-an-hour.
 Test when laid and jointed:—20,000 Volts for half-an-hour.

TABLE LII.

Engineering Standards Committee's Table of Thicknesses of Insulation for Rubber-Insulated Concentric Underground Cables for Pressures exceeding 660 Volts.

Nominal Area of Conductors.	From 600 to 2,200 Volts.				From 2,200 to 3,300 Volts.				From 3,300 to 6,000 Volts.				From 6,000 to 11,000 Volts.			
	Outer Dielectric.				Outer Dielectric.				Outer Dielectric.				Outer Dielectric.			
	Inner Dielectric.	Earthen.	Not Earthen.	Lead.	Inner Dielectric.	Earthen.	Not Earthen.	Lead.	Inner Dielectric.	Earthen.	Not Earthen.	Lead.	Inner Dielectric.	Earthen.	Not Earthen.	Lead.
Square Inch.	Inch.	Inch.	Inch.	Inch.	Inch.	Inch.	Inch.	Inch.	Inch.	Inch.	Inch.	Inch.	Inch.	Inch.	Inch.	Inch.
.025	.11	.07	.11	.08	.13	.08	.13	.08	.20	.09	.20	.09	.29	.10	.29	.10
.050	.11	.07	.11	.09	.13	.08	.13	.09	.20	.09	.20	.10	.29	.10	.29	.10
.075	.12	.08	.12	.09	.14	.09	.14	.10	.21	.10	.21	.10	.30	.11	.30	.11
.100	.12	.08	.12	.10	.14	.09	.14	.10	.21	.10	.21	.11	.30	.11	.30	.11
.125	.12	.08	.12	.10	.14	.09	.14	.10	.21	.10	.21	.11	.30	.11	.30	.12
.150	.13	.09	.13	.11	.15	.10	.15	.11	.22	.11	.22	.12	.31	.12	.31	.12
.200	.13	.09	.13	.11	.15	.10	.15	.11	.22	.11	.22	.12	.31	.12	.31	.13
.250	.13	.09	.13	.12	.15	.10	.15	.12	.22	.11	.22	.13	.31	.12	.31	.13

ELECTRIC RAILWAY ENGINEERING

TABLE LIII.

Engineering Standards Committee's Table of Thicknesses of Insulation for Rubber-Insulated Three-Core Underground Cables for Pressures exceeding 650 Volts.

Nominal Area of Conductors.	From 650 to 2,200 Volts.		From 2,200 to 3,300 Volts.		From 3,300 to 6,600 Volts.		From 6,600 to 11,000 Volts.	
	Dielectric on each Core.	Lead.	Dielectric on each Core.	Lead.	Dielectric on each Core.	Lead.	Dielectric on each Core.	Lead.
Square Inch.	Inch.	Inch.	Inch.	Inch.	Inch.	Inch.	Inch.	Inch.
·025	·11	·09	·13	·10	·20	·11	·29	·12
·050	·11	·10	·13	·11	·20	·12	·29	·13
·075	·12	·11	·14	·11	·21	·13	·30	·14
·100	·12	·12	·14	·12	·21	·13	·30	·15
·125	·12	·12	·14	·12	·21	·14	·30	·15
·150	·13	·13	·15	·13	·22	·14	·31	·16
·200	·13	·13	·15	·14	·22	·15	·31	·17
·250	·13	·14	·15	·14	·22	·16	·31	·17

The following are further abstracts from the Engineering Standards Committee's report:—

The dielectric and lead on all conductors, whether mains or pilot wires, smaller than 0·025 sq. in., shall have the thicknesses given for 0·025 sq. in. All intermediate sizes shall have the thicknesses given for the next larger size on the list.

Twin cables shall have the same thicknesses as three-core cables.

The allowable variation in radial thicknesses of dielectric and lead at any point shall be 10 per cent. below the standard minimum thicknesses given in the table, but the mean of the thicknesses shall be at least that specified.

The standard armouring to be as follows:—

For cables below 0·50 in. diameter over lead, galvanised steel wires 0·072 in. diameter.

For cables from 0·50 in. to 1 in. over lead, two layers of compound steel tape, each 0·030 in. thick.

For cables from 1·01 in. to 2 ins. diameter, two layers of compound steel tape, each 0·040 in. thick.

Above 2 ins. diameter, by two layers of compound steel tape, each 0·060 in. thick.

The standard thicknesses of jute serving, when applied to diameters less than 0·50 in., to be 0·06 in., and for larger diameters 0·10 in.

All test pressures may be applied either with alternating or direct current, the former to be at the standard frequency.

The pressure tests for the cables in these tables shall be as follows:—

Working Pressure.	Test at Works.	Test when laid and jointed.
	Pressure applied for half an hour.	Pressure applied for half an hour.
	Volts.	Volts.
2,200	16,000	4,000
3,300	12,000	6,000
6,600	20,000	12,000
11,000	30,000	20,000

THE HIGH TENSION TRANSMISSION SYSTEM

Overhead High Tension Lines.

Even in England there is a tendency to employ overhead high tension lines in certain cases, such, for instance, as where a railway can use its own right of way. Where an overhead high tension transmission line is employed, some very different questions present themselves for solution, and they may be conveniently treated as follows :—

Let \longrightarrow = received voltage at end of transmission line. Then the phase relations of the voltage and current components are as indicated by the following vectors :—

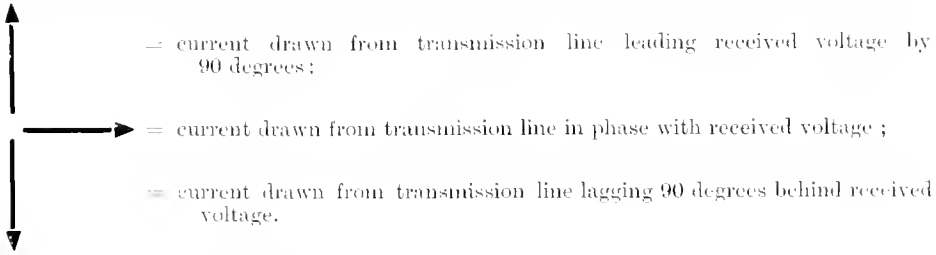

Before proceeding with the estimation, the current drawn from the transmission line should be resolved into the “ energy ” component and the “ wattless ” component.

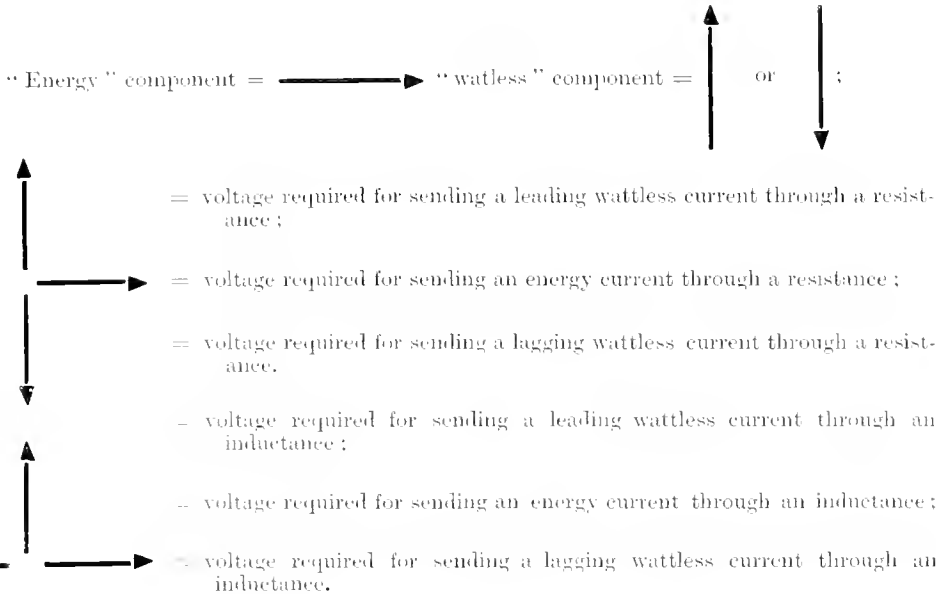

In the above it will be noted that the electromotive force is in phase with the current when driving it through a resistance, and leads it by 90 degrees when driving it through an inductance.

In order to obtain at the end of the line the desired “ received voltage ”—



some or all of the above component voltages (according to the nature of the transmission line) have to be calculated, and combined with the received

ELECTRIC RAILWAY ENGINEERING

voltage, which must be supplied at the source. Thus in the following diagram—

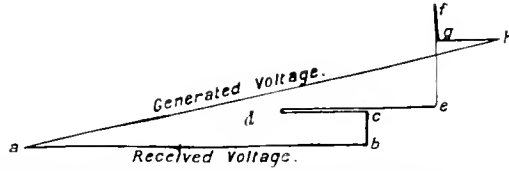

- a b* = voltage required at the receiving end of the transmission line :
- b c* = voltage required for sending leading wattless current¹ through line resistance ;
- c d* = voltage required for sending leading wattless current¹ through line inductance ;
- d e* = voltage required for sending energy current through line resistance ;
- e f* = voltage required for sending energy current through line inductance ;
- f g* = voltage required for sending lagging wattless current through line resistance ;
- g h* = voltage required for sending lagging wattless current through line inductance ;
- a h* = voltage required to be generated.

Table LIV. gives resistances for calculating the resistance voltages.

Table LV. gives reactances for calculating the reactance voltages.

Table LVI. gives the capacity and corresponding charging current per unit of length.

Regarding the charging current, it should be pointed out that this is merely a function of the size of conductors, distance apart, voltage, and periodicity, and is independent of the load, being, in fact, always the same as at open circuit.

$$\text{Charging current} = \frac{2 \pi \times \text{cycles per second} \times \text{voltage} \times \text{capacity in microfarads}}{10^6}.$$

It has been found to be sufficiently accurate to regard the charging current per unit of length of line as the same at all points of the line. Hence, in calculating the voltage due to the charging current across resistance and reactance of line, one may take half the total charging current through the entire resistance and reactance.

The use of the preceding rules and tables is best illustrated by an example.

Example.

Three-phase transmission plant.

Power to be delivered at full load = 9,000 kilowatts.

Power factor at full load = .9 for delivered energy.

Length of line = 100 kilometres.

Periodicity = 50 cycles per second.

Volts between lines = 40,000 at receiving end.

Volts per phase = 23,100 at receiving end.

Allow 3 per cent. reactance voltage for step-up transformers.

Allow 3 per cent. reactance voltage for step-down transformers.

Conductors of transmission line arranged on the three corners of an equilateral triangle.

Distance between conductors = 100 centimetres.

Cross section of conductor = 75 square millimetres.

Diameter of conductor = 9.77 millimetres.

From Table LIV.—Resistance per kilometre = .229 ohm.

From Table LV.—Reactance per kilometre = .353 ohm.

From Table LVI.—Charging current per kilometre at 10,000 volts = .0189 ampere.

¹ Often charging current.

THE HIGH TENSION TRANSMISSION SYSTEM

TABLE LIV.

Resistances and Weights of Copper Conductors of various Sizes.

Cross-section of Conductor in Square Millimetres.	Diameter of Conductor in Millimetres.	Resistance of Conductor in Ohms per Kilometre at 20° Centigrade.	Weight of Conductor in Kilogrammes per Kilometre.	Cross-section of Conductor in Square Millimetres.	Diameter of Conductor in Millimetres.	Resistance of Conductor in Ohms per Kilometre at 20° Centigrade.	Weight of Conductor in Kilogrammes per Kilometre.
20	5.04	.860	178	90	10.7	.191	801
25	5.64	.688	223	95	11	.181	845
30	6.19	.574	267	100	11.3	.172	890
35	6.67	.492	312	110	11.8	.156	980
40	7.12	.430	356	120	12.4	.143	1068
45	7.57	.382	401	130	12.9	.132	1158
50	7.97	.344	445	140	13.4	.123	1246
55	8.36	.313	490	150	13.8	.115	1335
60	8.75	.287	534	160	14.3	.108	1424
65	9.09	.265	578	170	14.7	.101	1512
70	9.43	.246	624	180	15.1	.096	1602
75	9.77	.229	668	190	15.6	.091	1690
80	10.1	.215	712	200	16.0	.086	1780
85	10.4	.202	756				

TABLE LV.

Inductances and Reactances of Copper Conductors.

Inductance in Henrys of each of the Three Conductors of a Three-phase Transmission Line, per Kilometre of Length of Line, when the Conductors are arranged at the Three Corners of an Equilateral Triangle.								Reactance in Ohms at 50 Cycles per Second, of each of the Three Conductors of a Three-phase Transmission Line per Kilometre of Length of Line when the Conductors are arranged at the Three Corners of an Equilateral Triangle.								
Distance between Centres of any Two Conductors in Centimetres.								Distance between Centres of any Two Conductors in Centimetres.								
Cross-section of Conductor in Square Millimetres.	30.	40.	60.	80.	100.	120.	140.	Diameter of Conductor in Millimetres.	30.	40.	60.	80.	100.	120.	140.	Cross-section of Conductor in Square Millimetres.
20	.00098	.00105	.00114	.00121	.00125	.00128	.00130	5.04	.308	.331	.358	.379	.393	.403	.409	20
25	.00097	.00104	.00112	.00119	.00123	.00126	.00128	5.64	.304	.328	.353	.373	.388	.397	.403	25
30	.00095	.00102	.00110	.00116	.00121	.00124	.00126	6.19	.300	.320	.346	.366	.382	.390	.396	30
35	.00094	.00100	.00108	.00115	.00120	.00122	.00124	6.67	.296	.315	.341	.362	.376	.385	.391	35
40	.00093	.00099	.00107	.00114	.00118	.00121	.00123	7.12	.292	.311	.337	.358	.372	.381	.387	40
45	.00092	.00098	.00106	.00113	.00117	.00120	.00122	7.57	.288	.307	.334	.355	.369	.378	.384	45
50	.00091	.00096	.00105	.00112	.00116	.00119	.00121	7.97	.284	.303	.330	.351	.366	.374	.381	50
55	.00090	.00096	.00104	.00111	.00115	.00118	.00120	8.36	.281	.301	.327	.348	.363	.371	.378	55
60	.00089	.00095	.00103	.00110	.00114	.00117	.00120	8.75	.278	.298	.325	.345	.360	.368	.376	60
65	.00088	.00094	.00102	.00108	.00111	.00116	.00119	9.09	.276	.296	.322	.341	.357	.365	.373	65
70	.00087	.00094	.00102	.00108	.00113	.00116	.00118	9.43	.274	.294	.320	.339	.355	.364	.371	70
75	.00087	.00093	.00101	.00107	.00112	.00115	.00117	9.77	.272	.292	.318	.337	.353	.362	.369	75
80	.00086	.00093	.00100	.00107	.00111	.00114	.00117	10.10	.270	.291	.315	.335	.350	.360	.367	80
85	.00085	.00092	.00100	.00106	.00111	.00114	.00116	10.40	.268	.289	.313	.334	.348	.359	.365	85
90	.00085	.00091	.00099	.00106	.00110	.00113	.00116	10.70	.266	.287	.311	.332	.346	.357	.364	90
95	.00084	.00091	.00099	.00105	.00109	.00113	.00115	11.00	.264	.286	.310	.330	.344	.355	.362	95
100	.00083	.00090	.00098	.00104	.00109	.00112	.00114	11.30	.262	.284	.308	.327	.342	.353	.360	100
110	.00083	.00090	.00097	.00103	.00108	.00112	.00114	11.80	.260	.282	.306	.325	.340	.351	.358	110
120	.00082	.00089	.00096	.00102	.00107	.00111	.00113	12.40	.258	.279	.303	.321	.337	.349	.356	120
130	.00081	.00088	.00096	.00101	.00106	.00110	.00113	12.90	.256	.276	.301	.319	.333	.347	.354	130
140	.00081	.00087	.00095	.00101	.00105	.00110	.00112	13.40	.255	.274	.299	.317	.331	.345	.352	140
150	.00080	.00087	.00094	.00100	.00104	.00109	.00112	13.80	.253	.272	.297	.315	.329	.343	.351	150
160	.00080	.00086	.00094	.00100	.00104	.00108	.00111	14.30	.252	.271	.295	.313	.327	.341	.349	160
170	.00080	.00086	.00093	.00099	.00103	.00108	.00111	14.70	.251	.270	.294	.311	.325	.339	.348	170
180	.00079	.00086	.00093	.00099	.00103	.00107	.00110	15.10	.250	.269	.293	.310	.324	.338	.347	180
190	.00079	.00085	.00093	.00098	.00103	.00107	.00110	15.60	.249	.268	.292	.309	.323	.337	.346	190
200	.00079	.00085	.00092	.00098	.00102	.00107	.00110	16.00	.248	.267	.291	.308	.322	.336	.345	200

The values in the above table also give the inductance and reactance per kilometre of each conductor for single-phase lines.

For three-phase lines, where the three conductors are arranged equispaced in one straight line, the calculations must be made on the basis of the distance between adjacent conductors for two-thirds of the length of the line, and on the basis of twice this distance for the remaining one-third of the length of the line.

ELECTRIC RAILWAY ENGINEERING

TABLE LVI.

Capacities and Charging Currents of Copper Conductors.

Cross-section of Conductor in Square Millimetres.	Capacity in Microfarads per Kilometre in a Three-phase Transmission Line, when the Conductors are arranged at the Three Corners of an Equilateral Triangle.							Diameter of Conductor in Millimetres.	Charging Current in Amperes at 50 Cycles per Second in each of the Three Conductors on a Three-phase Transmission Line, per Kilometre of Length of Line, when the Conductors are arranged at the Three Corners of an Equilateral Triangle 10000 R.M.S. Volts between any Two Conductors.							Cross-section of Conductor in Square Millimetres.
	Distance between Centres of any Two Conductors in Centimetres.								Distance between Centres of any Two Conductors in Centimetres.							
	30.	40.	60.	80.	100.	120.	140.		30.	40.	60.	80.	100.	120.	140.	
20	0117	0108	0100	0095	0092	0089	0088	5.61	0212	0196	0181	0172	0167	0162	0160	20
25	0119	0112	0102	0097	0094	0091	0089	5.64	0216	0204	0185	0176	0171	0165	0162	25
30	0121	0114	0104	0098	0095	0092	0090	5.69	0220	0207	0189	0178	0172	0167	0163	30
35	0123	0116	0106	0100	0097	0093	0091	5.67	0223	0210	0192	0181	0176	0169	0165	35
40	0125	0117	0108	0101	0098	0094	0092	7.12	0227	0212	0196	0183	0178	0171	0167	40
45	0126	0119	0109	0103	0098	0095	0093	7.75	0229	0216	0198	0187	0178	0172	0169	45
50	0128	0120	0110	0104	0099	0096	0094	7.97	0232	0218	0200	0189	0180	0174	0171	50
55	0129	0121	0111	0105	0100	0097	0095	8.36	0234	0220	0202	0191	0181	0176	0172	55
60	0131	0122	0112	0106	0101	0098	0096	8.75	0238	0222	0204	0192	0183	0178	0174	60
65	0132	0123	0113	0107	0102	0099	0097	9.09	0240	0223	0205	0194	0185	0180	0176	65
70	0133	0124	0114	0108	0103	0100	0097	9.43	0242	0225	0207	0196	0187	0181	0176	70
75	0134	0125	0115	0109	0104	0101	0098	9.77	0244	0227	0209	0198	0189	0183	0178	75
80	0135	0126	0115	0109	0104	0101	0099	10.1	0245	0229	0209	0198	0189	0183	0180	80
85	0136	0127	0116	0110	0105	0102	0099	10.4	0247	0230	0210	0200	0191	0185	0180	85
90	0137	0127	0117	0111	0106	0102	0100	10.7	0249	0230	0212	0202	0192	0185	0181	90
95	0138	0128	0118	0111	0106	0103	0101	11.0	0250	0232	0214	0202	0192	0187	0183	95
100	0139	0129	0119	0112	0107	0104	0102	11.3	0252	0234	0216	0204	0194	0189	0185	100
110	0140	0130	0119	0113	0108	0105	0103	11.8	0254	0236	0216	0205	0196	0191	0187	110
120	0142	0131	0120	0114	0109	0106	0104	12.4	0258	0238	0218	0207	0198	0192	0189	120
130	0143	0132	0121	0115	0110	0107	0105	12.9	0260	0240	0220	0209	0200	0194	0191	130
140	0144	0132	0122	0116	0111	0108	0106	13.4	0262	0240	0222	0210	0202	0196	0192	140
150	0145	0133	0123	0117	0112	0109	0107	13.8	0263	0242	0223	0212	0204	0198	0194	150
160	0146	0134	0124	0117	0113	0110	0107	14.3	0265	0244	0225	0212	0205	0200	0194	160
170	0147	0135	0125	0118	0114	0111	0108	14.7	0267	0245	0227	0214	0207	0202	0196	170
180	0147	0135	0126	0119	0115	0112	0109	15.1	0267	0245	0229	0216	0209	0204	0198	180
190	0148	0136	0126	0120	0115	0112	0110	15.6	0268	0247	0229	0218	0209	0204	0200	190
200	0149	0137	0127	0121	0116	0113	0111	16.0	0270	0249	0230	0220	0210	0205	0202	200

The capacities given above are the capacities between one wire and neutral point (*i.e.*, point of zero potential). For single-phase the distance to neutral point is only 866 as great for a given distance between conductors, and hence the capacity per conductor is slightly greater.

The capacity for any relative arrangement of the wires will not differ greatly from the values above given.

For a single-phase transmission line, for a given distance between conductors, the charging current is slightly greater than for a three-phase transmission line, per kilometre of length of line, at a given periodicity and a given voltage between conductors and a given diameter of conductor.

The influence of the earth on the capacity of aerial lines may generally be neglected.

Hence resistance per conductor = 22.9 ohms.

Hence reactance per conductor = 35.3 ohms.

Charging current for conductor at 40,000 volts = $4 \times 100 \times 0.0189 = 7.55$ amperes.

Total full load current per phase for 0.9 P.F. of delivered energy = $\frac{3,000,000}{231,000} \times 0.9 = 115$ amperes.

Energy component of full load current = 130 amperes.

Wattless component of full load current = 63 amperes.

THE HIGH TENSION TRANSMISSION SYSTEM

Combined reactance voltage of step-up and step-down transformers = $0.06 \times 23,100 = 1,390$ volts.

$$\text{Reactance} = \frac{1390}{130} = 10.7 \text{ ohms.}$$

Reactance of line plus transformers = $35.3 + 10.7 = 46.0$ ohms.

Voltage required for sending charging current through line reactance = $\frac{7.55}{2} \times 22.9 = 86.5 = b c$.

Voltage required for sending charging current through reactance = $\frac{7.55}{2} \times 46.0 = 174 = c d$.

Voltage required for sending energy current through line resistance = $130 \times 22.9 = 2,980 = d e$.

Voltage required for sending energy current through reactance = $130 \times 46.0 = 6,000 = e f$.

Voltage required for sending lagging wattless components through line resistance = $63 \times 22.9 = 1,440 = f g$.

Voltage required for sending lagging wattless component through reactance = $63 \times 46.0 = 2,900 = g h$.

These are plotted in the following diagram :—

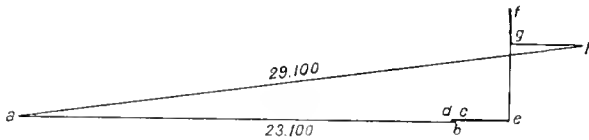

and from the relative lengths of the lines $a h$ and $a b$ the necessary voltage at the generating end is found to be 29,100.

For unity power factor of the delivered energy, the components $f g$ and $g h$ become zero, and the diagram becomes as follows :—

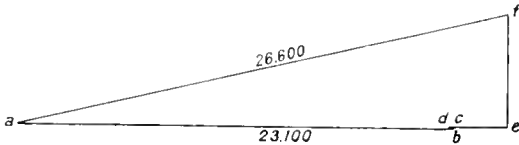

the voltage at the generating end being but 26,600, for obtaining 23,100 at the receiving end.

In the next diagram the P.F. is taken at 0.95. For this value the wattless component of the load current is 45.5 amperes.

$$\text{Hence } f g = 45.5 \times 22.9 = 1,040 \text{ volts.}$$

$$g h = 45.5 \times 46.0 = 2,090 \text{ volts.}$$

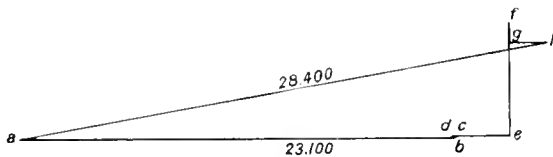

ELECTRIC RAILWAY ENGINEERING

The diagram for P.F. = 0.8 is next given:—

$$fg = 87 \times 22.9 = 1,990 \text{ volts.}$$

$$gh = 87 \times 46.0 = 4,000 \text{ volts.}$$

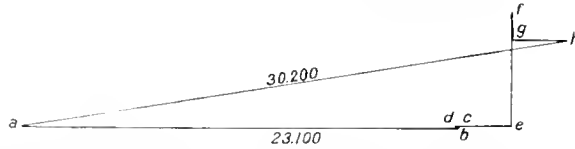

For a power factor of 0.6, the wattless component of the received current is 115 amperes.

$$fg = 115 \times 22.9 = 2,640 \text{ volts.}$$

$$gh = 115 \times 46.0 = 5,300 \text{ volts.}$$

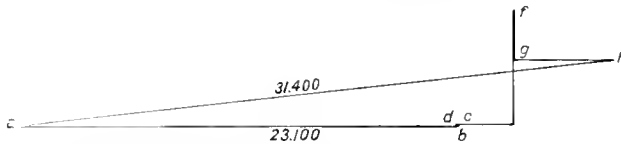

In the curve in Fig. 145 there are plotted against the power factors the voltages required at the generating end of the line in order to maintain a constant voltage of 23,100 volts per phase (40,000 volts between lines) at the receiving end of the line.

The writers arrived at the method above described while endeavouring to simplify and

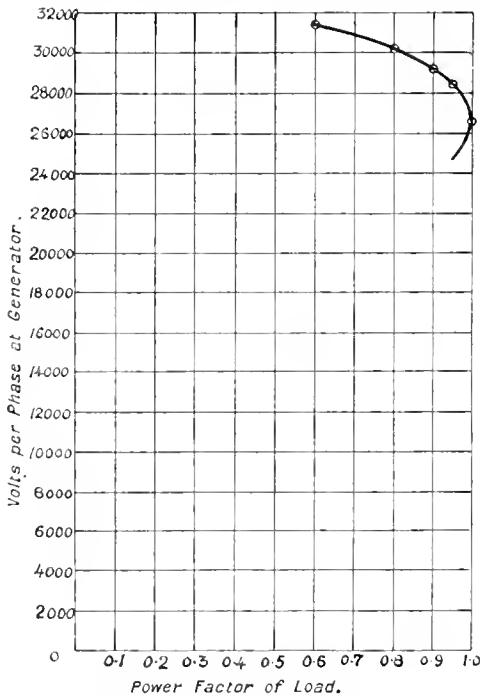

FIG. 145. CURVE SHOWING VOLTAGE REQUIRED AT GENERATOR FOR 23,100 VOLTS PER PHASE AT RECEIVING END WITH DIFFERENT POWER FACTORS.

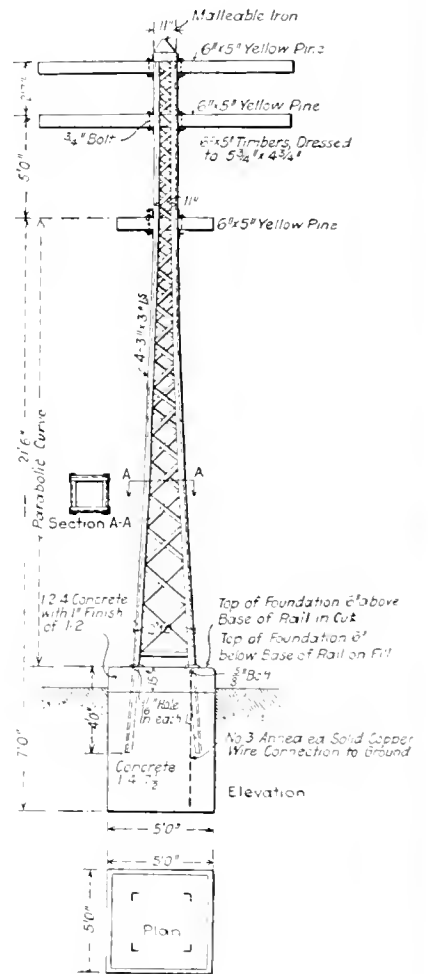

FIG. 145A. NEW YORK CENTRAL RAILWAY: PLAN, ELEVATION, AND SECTIONS OF POLE FOR TRANSMISSION LINES.

THE HIGH TENSION TRANSMISSION SYSTEM

to render more useful for every-day work the methods described by Perrine and Baum in their paper read before the American Institute of Electrical Engineers on May 18th, 1905, and can, therefore, only claim originality with respect to the more general applicability and simplicity which they believe has been attained.

Fig. 145A is a drawing of a typical steel tower for supporting overhead high tension transmission lines. This tower is the standard employed by the New York Central Railway for the overhead portion of their transmission line. The tower is of latticed steel structure set in a bed of concrete. The cross arms are of yellow pine and the conductors spaced 36 inches apart. The poles are spaced 150 ft. apart on the straight and closer on curves, according to the radius. The insulators are mounted on steel pins. The transmission is at a pressure of 11,000 volts.

Chapter VII

THE SUB-STATIONS

FOR railways employing alternating current motors on the cars, the sub-stations, where employed, are equipped with stationary (or static) transformers, *i.e.*, with voltage-transforming apparatus not comprising any rotating parts. Where the voltage employed at the generating station for such railways is sufficiently low, the sub-stations are sometimes dispensed with altogether, and the voltage is transformed to the still lower value required by the motors, by means of transforming apparatus carried on the car or train. Indeed, in the course of the Berlin-Zossen tests, a locomotive was tested equipped with polyphase motors wound for a pressure of 10,000 volts, enabling voltage-transforming apparatus to be dispensed with altogether. As we shall see in a subsequent chapter, the single phase commutator motor, as at present developed, requires a rather low pressure at its terminals; hence transforming apparatus is employed on the car or train, in order to reduce the voltage on the rail or trolley from the customary 3,000 to 6,000 volts or higher, to some 250 volts at the motors.

All further allusions to alternating current systems, so far as relates to sub-stations, will, however, be reserved for the sections dealing with these systems in subsequent chapters.

In the present chapter we shall discuss the sub-station as employed in the three-phase, continuous-current system at present so extensively employed in electric traction.

As regards the equipment of sub-stations of this class, there arises the question of the type of transforming apparatus to be employed. We have the choice of two thoroughly reliable types. In the first the voltage is reduced from that of the high tension transmission line to a low voltage, by ordinary step-down stationary transformers. These step-down transformers are generally either of the air blast or of the oil-immersed, water-cooled type. In some cases, instead of the latter type, oil-cooled transformers are employed, the water-cooling system being dispensed with.

The low voltage current from the secondaries of the step-down transformers is next led through potential regulators to the alternating current side of rotary converters. These rotary converters may be either of the quarter-phase, three-phase, or six-phase type. Six-phase rotary converters are now almost invariably employed. The great advantages which six-phase rotaries possess over three-phase rotaries have been known for a number of years,¹ but the earlier roads had been equipped with three-phase rotaries, and it is only very recently that the conservatism and inertia which led to a continuance of their use has been largely overcome. Most new undertakings are using or arranging to use six-phase rotaries.

From the commutator (continuous-current) side of the rotary converters, the current, generally at from 550 to 650 volts, is led to the conductor rail or trolley.

¹ See the authors' treatise on "Electric Machine Design," Part III, (*Engineering*, 1906).

THE SUB-STATIONS

There are many points in favour of the alternative plan of substituting motor-generators for the above-described system of step-down transformers, potential regulators, and rotary converters.

When motor-generators are used, the current is supplied at the voltage of the high tension transmission line direct to the terminals of a synchronous motor which is direct-connected to a continuous-current generator which supplies current at from 550 to 650 volts to the conductor rail or trolley. Generally, as above-stated, the current is supplied to a synchronous motor without the interposition of step-down transformers. Where, however, the voltage employed on the high tension transmission line is greater than 12,000 volts, step-down transformers are generally employed. It is also highly probable that induction motors will be employed to a greater extent in future for driving the continuous-current generators. Where some of the motor-generator sets employ synchronous motors, and others employ induction motors, the lagging current of the latter may be offset by over-exciting the synchronous motors and thus causing them to absorb a leading current, so that the resultant current from the generating station and in the high tension transmission line may be in phase with the voltage. In like manner the resultant current may be adjusted to lead the voltage in phase, and this will occasion a rise of voltage on the transmission line if the over-excitation and the line inductance be sufficient, and will, with less over-excitation or line inductance, tend to partly offset the I.R. drop on the line.

Not only may we thus, in a system employing motor generators at the sub-station, very readily control the voltage, but even when such voltage control is inexpedient the continuous-current voltage supplied by the generator member of the motor-generator set will be altogether independent of variations in the alternating current voltage.

This continuous-current generator will be in all respects the equivalent of a continuous-current generator direct-connected to an engine with the same percentage speed regulation as that of the large steam engines at the generating station. The sub-station continuous-current generator may be shunt-wound, or it may be compounded for constant terminal voltage at all loads, or for a voltage increasing with the load. The amount of loss in the high tension transmission line has no influence upon its operation. One may, and, in long distance transmission, must, from economical considerations, have 20 per cent. voltage drop, or even higher, in the high-tension line, and yet may have just as perfect voltage regulation at the commutator of the continuous-current generator as could be obtained with 5 per cent. drop or less. Thus, in a case where motor generators are employed, one will expend just so much for transmission cables as to obtain maximum economy when estimated on the basis of the interest on this capital outlay for cables and the cost of producing the energy dissipated in the transmission line. But when rotary converters are used, it becomes practically impossible to obtain satisfactory automatic control of the commutator voltage with more than 5 per cent. to 10 per cent. resistance drop in the high-tension line, and a thoroughly excellent result is only to be obtained by a very low resistance drop. Hence a successful plant with rotary converters in the sub-stations, only becomes economically possible where the length of transmission is not great, or where, in order to obtain a sufficiently low line drop, a higher voltage is employed for transmission than would be required for the operation of motor generators. These considerations have generally not been sufficiently emphasised in comparing the two systems. They corroborate the generally accepted view that the use of rotary converters is attended with higher

ELECTRIC RAILWAY ENGINEERING

efficiency in operation than is the case where motor generators are used. But they are at variance with another generally accepted conclusion, namely, that a lesser first cost may be attained by the use of rotary converters. This may often be the case for short distances, but for other conditions the greatly increased outlay necessary for cables will generally lead to the opposite result. The question resolves itself for any given case, into comparing the slightly greater interest on capital expenditure when rotary converters are used, against the cost of operation with motor generators. For conditions where this comparison shows little to choose between the two systems, motor generators should be employed on the score of their great superiority in convenience of operation.

In order to demonstrate the soundness of this position, the properties of these two types of apparatus will be examined.¹

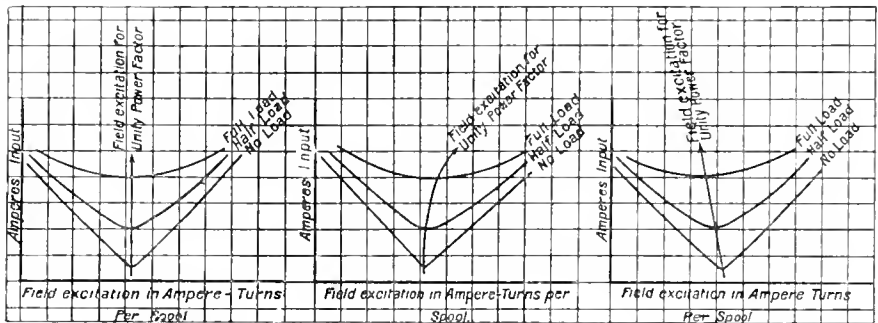

Fig. 146.

Fig. 147.

Fig. 148.

Figs. 146, 147, and 148. PHASE CHARACTERISTICS OF HYPOTHETICAL SYNCHRONOUS MOTORS.

Consider the case of a hypothetical synchronous motor and transmission system for which the following assumptions would hold:—

- (1) No reactance in armature;
- (2) No resistance in armature;
- (3) Constant voltage at collector rings.

The phase characteristics of such a motor would resemble the curves of Fig. 146, where a given constant field excitation corresponds to minimum current input for all loads, *i.e.*, to unity power factor for all loads.

Suppose next that assumptions 2 and 3 still hold good, but that the armature has reactance. In proportion to the magnitude of this reactance the curve of field excitation for unity power factor will bend toward the right, as shown in Fig. 147.

Should, on the other hand, assumptions 1 and 3 hold good, but should allowance require to be made for the resistance of the armature windings, Fig. 146 would be modified in the manner shown in Fig. 148, the curve of field excitation for unity power factor sloping to the left.

If instead of the third assumption, to the effect that there is constant voltage at the armature terminals of the synchronous motor, there is a drop of voltage in the line proportional to the load on the motor, the curve will be modified in the same way as by resistance drop in the armature, and the slope to the left will be greater the greater the line drop. If the arrangements should be such that the terminal voltage increases with the load, the effect would be to reduce the slope to the left occasioned by

¹ Most of the material on pp. 174 to 188 is reproduced with the kind permission of the *Electrical Review*, from an article by one of the authors, and entitled "Motor Generators and Rotary Converters," Vol. LIII., pp. 519—521, pp. 528—529, pp. 607—609, and pp. 647—650.

THE SUB-STATIONS

the armature resistance, or, with sufficient rise in terminal voltage, to bring the line back to the vertical, or even to swing it over to a slope to the right. Now, when a continuous-current generator is directly driven from such a synchronous motor, the commutator voltage, according to the method and adjustment of the excitation, may automatically decrease, remain constant, or increase with the load, and this source may be employed for the excitation of the synchronous motor. The net result from these considerations is that we may readily arrange, if necessary, by series coils in addition to shunt coils,¹ for a synchronous motor to be automatically excited with field currents suitable to secure practically unity power factor at all loads. This is the condition for a minimum loss of energy in the high tension transmission line, and for a minimum outlay for copper.

We may illustrate this by a practical case. Let a three-phase synchronous motor be direct-connected to a continuous current generator of 800-K.W. rated output, compounded for a terminal voltage of 500 volts at no load, and 525 volts at full load. At 89 per cent. combined efficiency for the set, the synchronous motor will absorb

$$\frac{800}{0.89} = 900 \text{ K.W. at full load.}$$

The motor has an external stationary armature with Y-connected windings, fed over a three-core cable direct from the central station, no other apparatus being supplied from this cable. The central station voltage is maintained constant at 5,800 volts, and at full load of the synchronous motor at unity power factor, the drop in transmission line plus armature resistance is 10 per cent. per phase, the voltage at the motor (considering the armature resistance to be transferred and added to the line) thus falling from 5,800 volts at no load to

$$5,800 \times .90 = 5,200 \text{ volts}$$

at full load.

The voltage per phase in the armature is

$$\frac{5,800}{1.73} = 3,350 \text{ volts at no load,}$$

and

$$\frac{5,200}{1.73} = 3,000 \text{ volts at full load.}$$

The current per phase is thus

$$\frac{900,000}{3 \times 3,000} = 100 \text{ amperes at full load.}$$

Let the slots and windings of the synchronous motor be so proportioned that at 100 amperes the reactance voltage per phase is 1,000 volts, and let the combined armature strength of the three phases amount to 4,200 maximum ampere turns per pole. Let the field excitation required for 5,800 terminal volts at no load, equal 7,000 ampere turns per pole.

The first step is to find the field excitation corresponding to 100 amperes per phase at unity power factor and 5,200 terminal volts.

We will take into account the saturation by estimating the *no load* ampere turns for 5,200 terminal volts, at

$$0.96 \times \frac{5,200}{5,800} \times 7,000 = 6,000 \text{ ampere turns.}$$

The armature demagnetisation, at 100 amperes and unity power factor, amounts to

$$\sin \left(\tan^{-1} \frac{1,000}{3,000} \right) \times 4,200 = 0.32 \times 4,200 = 1,350 \text{ ampere turns.}$$

¹ In cases where a compound-wound synchronous motor would be required, the armature would have to be of the internal revolving type.

ELECTRIC RAILWAY ENGINEERING

Hence at full load of 100 amperes input, and 5,200 terminal volts, the excitation required for unity power factor would be

$$6,000 + 1,350 = 7,350 \text{ ampere turns};$$

and to obtain approximately unity power factor from no load to full load, the field excitation should automatically increase from 7,000 to 7,350 ampere turns per pole, that is, by 5 per cent.

This corresponds to the over-compounding provided for the direct-connected continuous-current generator (500 volts at no load up to 525 volts at full load); hence the excitation of the synchronous motor may be provided from that source, and an automatic control of the power factor at approximately unity, will be obtained for all loads.

Of course it is by no means necessary to obtain so close an agreement, since a very considerable deviation from the correct excitation will not occasion more than 1 or 2 per cent. deviation from unity power factor. It is evident that by designing a synchronous motor with suitable armature inductance, armature strength, resistance, and degree of saturation, it may be arranged for automatic operation at practically unity power factor for any reasonable value of line drop and of over-compounding of the continuous current generator which it drives.

Although the constants of the synchronous motor used for illustrating this explanation were chosen at random and are in no sense put forward as representing an ideal or even carefully considered design, it may be of interest to plot its estimated phase characteristics when operated under the conditions set forth. These are given in Fig. 149 for no load, half-load, and full load. The curve passing through the minimum points corresponds to unity power factor, but excitations corresponding to any

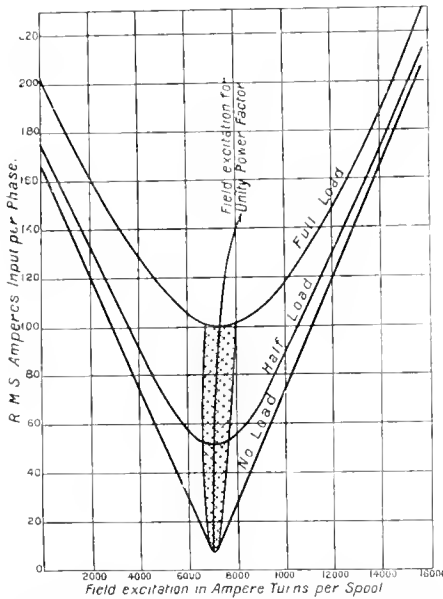

Fig. 149. PHASE CHARACTERISTICS OF SYNCHRONOUS MOTOR FOR 900-K.W. INPUT AT RATED LOAD.

part of the shaded area shown will give at least 0.99 power factors, thus permitting at full load a total range of variation of the excitation of about 20 per cent., so that it would not be worth while to modify the design of the synchronous motor for the sake of obtaining better conditions in this respect, even for very different line constants, or requirements as to over-compounding of the continuous current generator.

The characteristic curves of Fig. 149 were estimated on the basis of the armature's magneto-motive force being equivalent to that of the field spools in the proportion of

$$1 \text{ root-mean-square ampere turn per pole per phase,}$$

representing a resultant armature strength per pole capable of replacing

$$1 \times \sqrt{2} \times 2 = 2.83 \text{ ampere turns per field spool,}$$

this being a proportion experimentally verified by an analysis of a number of three-phase machines of a wide range of designs.

It should not be necessary to follow up this investigation any further so far as concerns demonstrating that, with any line loss that could be economically permitted, synchronous motors with automatic control for high power factor may be satisfactorily employed to drive continuous current generators, which latter, with any range of

THE SUB-STATIONS

compounding within customary requirements, may serve as supply for the synchronous motor's field excitation.

It will now be demonstrated that with rotary converters, a very different state of affairs exists in this respect.

An analysis of the observed no-load phase characteristic curves of a number of three-phase rotary converters of a wide range of ratings with respect to the outputs, speeds, periodicities, and voltages, yielded as an average result for estimating the effectiveness of the armature magneto-motive for replacing the field magneto-motive force the following rule:—

“When in a rotary converter the magneto-motive force is derived from the armature winding itself, in virtue of the wattless component of the alternating current entering the armature, a root-mean-square (R.M.S.) value of the armature ampere turns per pole-piece per phase, represented by 1·00, equals in effectiveness a field excitation of 2·15.”

The expression “six-phase rotary converter” is slightly misleading. It would be better described as a three-phase machine with six slip-rings. For the purpose of this discussion it is immaterial whether it is distinctly kept in mind that the machine has six rings, and it will be convenient to denote by *Y* current the current equivalent to one branch of the *Y* in a *Y*-connected synchronous motor of the same capacity and voltage.¹ Similarly, by *Y* voltage will be denoted the voltage from the common connection to any one terminal of such an equivalent synchronous motor.

The arrangement of the armature slots and windings, and the general proportions of a rotary converter, are such that it has a comparatively small reactance, and in the following investigation the effect of the reactance has been neglected in the interests of simplifying the necessarily very tedious work. The conclusions are not thereby appreciably affected.

A little consideration will suffice to show that so far, as relates to obtaining satisfactory automatic regulation of the commutator voltage by means of phase regulation, there should be employed a comparatively weak armature expressed in armature ampere turns per pole, low saturation, and low armature resistance. These conditions lead to much more liberally proportioned rotary converters than would otherwise be necessary. But in order not to make out too unfavourable a case for the rotary converter, from the standpoint of regulation by phase control, the estimations have been based upon a machine with these features, and therefore of decidedly liberal proportions.

In Table LVII. are set forth the data assumed for the rotary converter:—

TABLE LVII.

Data of 600-K.W. Rotary Converter.

Rated output	600 K.W.
Commutator voltage	600 volts.
Number of poles	12.
Periodicity in cycles per second	25.
Speed in revolutions per minute	250.
Internal voltage at full load output	613 volts.
Full load current	1,000 amperes.
Full load efficiency at unity power factor	96 %.
<i>Y</i> voltage = $\frac{600 \times 0.615}{1.73}$ =	213.

¹ In the case of a rotary converter with three slip rings, this is the current per slip ring; for the case of six slip rings it is twice the current per slip ring. In both cases, the alternating current component of the total current per armature conductor, is equal to this *Y*-current divided by $\sqrt{3}$ and by the number of pairs of poles for a multiple-circuit single winding, or by 2, independently of the number of poles, for a two-circuit single winding.

ELECTRIC RAILWAY ENGINEERING

At unity power factor the Y amperes input are equal to

$$\frac{600,000}{0.96 \times 3 \times 213} = 980 \text{ amperes.}$$

The armature winding is of the twelve-circuit single type.

The alternating current component of the resultant current per armature conductor, at full load and unity power factor, is equal to

$$\frac{980}{1.73 \times 6} = 94.0 \text{ amperes.}$$

The assumed saturation curve for this machine is given in Fig. 150. This shows for 613 internal volts 8,900 ampere turns per field spool, and for 600 volts 8,600 ampere turns.

Hence the ordinates of the full load characteristic for the point of minimum current (unity power factor) are

980 amperes and 8,900 ampere turns.

The machine has 60 segments and 60 turns per pole, consequently 20 turns per pole per phase. To replace 8,900 ampere turns per field spool, the armature current required is

$$\frac{8,900}{2.15} \times 20 = 208 \text{ amperes per armature conductor.}$$

This corresponds to a total wattless current input of

$$\frac{208}{94.0} \times 980 = 2,170 \text{ amperes per phase.}$$

Fig. 150. SATURATION CURVE OF A 600-K.W. ROTARY CONVERTER.

Hence for zero field excitation and full load output the total current input is equal to

$$\sqrt{980^2 + 2,170^2} = 2,380 \text{ amperes.}$$

By determining in a similar manner the armature current required to replace, not the *whole* excitation, as in the above example, but portions thereof, the values in Table LVIII. have been derived:—

TABLE LVIII.

Amperes Input to Rotary Converter with Varying Field Excitation, at Full Load Output.

Voltage at Commutator.	Amperes Output from Commutator.	Field Excitation in Ampere Turns.	Y Amperes Input per Phase.
600	1,000	0	2,380
600	1,000	3,000	1,760
600	1,000	6,000	1,200
600	1,000	8,900	980
600	1,000	11,900	1,200
600	1,000	14,900	1,760
600	1,000	17,900	2,380

THE SUB-STATIONS

Calculations at other loads give the results in Table LIX, for the amperes input per phase at varying excitation:—

TABLE LIX.

Amperes Input to Rotary Converter with Varying Field Excitation for various Outputs.

Ampere Turns Field Exc. for Following Continuous-current Outputs.										Y Amperes Input.							
0 Amperes.	250 Amperes.	500 Amperes.	750 Amperes.	1,000 Amperes.	1,250 Amperes.	1,500 Amperes.	1,750 Amperes.	0 Amperes Output from Commutator.	250 Amperes Output from Commutator.	500 Amperes Output from Commutator.	750 Amperes Output from Commutator.	1,000 Amperes Output from Commutator.	1,250 Amperes Output from Commutator.	1,500 Amperes Output from Commutator.	1,750 Amperes Output from Commutator.		
0	0	0	0	0	0	0	0	0	2,110	2,180	2,240	2,290	2,380	2,540	2,690	2,860	
3,000	3,000	3,000	3,000	3,000	3,000	3,000	3,000	3,000	1,400	1,440	1,520	1,628	1,760	1,920	2,090	2,300	
6,000	6,000	6,000	6,000	6,000	6,000	6,000	6,000	6,000	650	720	820	1,010	1,200	1,390	1,630	1,880	
8,600	8,690	8,780	8,870	8,900	9,040	9,130	9,210	40	255	485	715	980	1,190	1,435	1,700	1,980	
11,200	11,380	11,560	11,740	11,900	12,080	12,260	12,420	650	720	820	1,010	1,200	1,390	1,630	1,880	2,180	
14,200	14,380	14,560	14,740	14,900	15,080	15,260	15,420	1,400	1,440	1,520	1,628	1,760	1,920	2,090	2,300	2,540	
17,200	17,380	17,560	17,740	17,900	18,080	18,260	18,420	2,140	2,180	2,240	2,290	2,380	2,540	2,690	2,860	3,000	

These values are plotted in the curves of Fig. 151. The points at which the broken line *a, b* intersects the various load characteristics, correspond to the values of the total excitation automatically obtained when the shunt winding is adjusted to supply a constant excitation of 6,000 ampere turns, and the series winding to give 3,850 ampere-turns at the full load output of 1,000 amperes, this being 64 per cent. compounding at full load. This adjustment corresponds to unity power factor at three-quarter load. The excitations at the different loads for the machine thus adjusted are given in Table LX.

TABLE LX.

Adjustment with 64 per cent. Compounding at Full Load, and for Unity Power Factor at 75 per cent. of Full Load.

Per cent. of Full Load.	Total Excitation in Ampere Turns per Pole.
0	6,000
25 per cent.	6,960
50	7,920
75	8,870
100	9,830
125	10,790
150	11,750
175	12,700

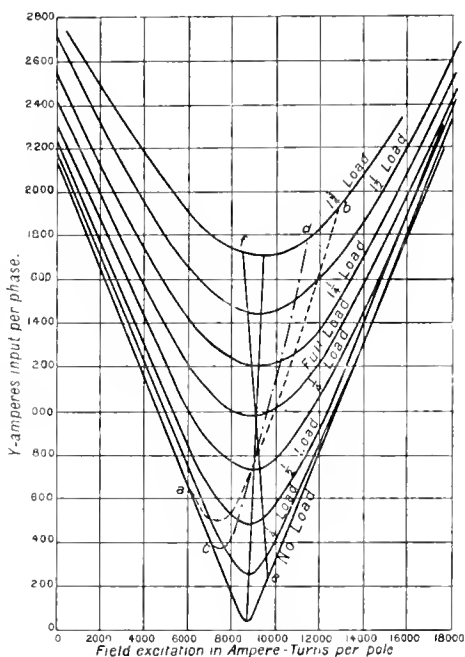

Fig. 151. CURVES SHOWING AMPERES INPUT PER PHASE AT VARIOUS LOADS OF A 600-K.W. ROTARY CONVERTER.

In Table LXI, are given the corresponding total amperes input per phase, the energy component, and the wattless component, together with the efficiency and the power factor at all loads.

ELECTRIC RAILWAY ENGINEERING

TABLE LXI.

Rotary Converter adjusted for Unity Power Factor at Three-quarter Load and 64 per cent. Compounding at Full Load.

Per cent. of Full Load Amperes Output from Commutator.	Commercial Efficiency of Rotary Converter.	Y Amperes Input to Rotary Converter per Phase.	Energy Component of Amperes Input.	Wattless Component of Amperes Input.	Power Factor.	Field Excitation (Ampere Turns per Spool).
0 %	0 %	640	25	640	0.039	6,000
25 %	88.0 %	495	255	425	0.515	6,960
50 %	94.2 %	530	485	212	0.915	7,915
75 %	95.4 %	720	720	0	1.00	8,870
100 %	96.0 %	990	970	195	0.980	9,830
125 %	95.4 %	1,255	1,190	400	0.950	10,790
150 %	94.6 %	1,570	1,440	615	0.920	11,750
175 %	93.5 %	1,910	1,700	872	0.890	12,700
200 %	92.0 %	2,300	1,980	1,175	0.860	13,650

The curves in Fig. 152 (facing p. 182) are plotted from the results set forth in Table LXI.

The next step is to investigate the performance of the rotary converter when thus adjusted. The rotary converter is to be operated from the secondaries of transformers whose primaries are fed over a high tension line. But for convenience of calculation the resistances and voltages will be reduced to the equivalent Y voltage of the rotary converter.

At no load, the Y voltage at the slip-rings of the rotary converter is

$$\frac{600 \times 0.615}{\sqrt{3}} = 213 \text{ volts.}$$

First assume that in transmission line, step-down transformers, and rotary converters, the equivalent resistance and the equivalent reactance are each equal to 0.01 ohm per phase. It is required to determine the voltage at the central station in order to obtain 600 volts at the commutator at no load. From Fig. 151 the input per phase is found to be 640 amperes and is practically wholly wattless. Hence

$$\text{Reactance voltage per phase} = 640 \times 0.01 = 6.4 \text{ volts.}$$

$$\text{Resistance voltage per phase} = 640 \times 0.01 = 6.4 \text{ volts.}$$

Constructing the diagram in Fig. 153, the "equivalent" voltage at the generating end of the line is found to be equal to 219.5 volts.

∴ At 219.5 volts at the generating end of the line, the no load commutator voltage is equal to 600 volts.

In Fig. 154 is given the corresponding diagram for half-load, the potential at the generating end being maintained constant at the value of 219.5 volts derived at no load. From the phase characteristic at half-load in Fig. 151, the total current input per phase is found to be 530 amperes, and the minimum value of the curve, 485 amperes, is the energy component. Hence the wattless component is equal to

$$\sqrt{530^2 - 485^2} = 212 \text{ amperes.}$$

The four component voltages obtained as the products of these component currents with the reactance of 0.01 ohm per phase and the resistance of 0.01 ohm per phase are—

$$485 \times 0.01 = 4.85,$$

$$485 \times 0.01 = 4.85,$$

$$212 \times 0.01 = 2.12,$$

$$212 \times 0.01 = 2.12.$$

THE SUB-STATIONS

and these are plotted in the diagram of Fig. 154, which shows that the Y voltage of the rotary converter has fallen from 213.0 volts to 212.3 volts, so that the commutator voltage is

$$\frac{212.3}{213.0} \times 600 = 598 \text{ volts.}$$

The diagrams in Figs. 155, 156 and 157 have been similarly derived for three-quarter load (when the current is in phase), and for 50 per cent. and 100 per cent. overloads (at which values the current leads).

These results are brought together in Table LXII.

<p><i>Y-voltage at rotary converter = 213.0 volts.</i></p> <p><i>"Equivalent" Y-voltage at generating end of line = 219.5 volts.</i></p>	Fig. 153.	No Load.
<p><i>"Equivalent" Y-voltage at generating end of line = 219.5 volts.</i></p> <p><i>Y-voltage at rotary converter = 212.3 volts.</i></p>	Fig. 154.	Half Load.
<p><i>"Equivalent" Y-voltage at generating end of line = 219.5 volts.</i></p> <p><i>Y-voltage at rotary converter = 212.3 volts.</i></p>	Fig. 155.	Three-Quarter Load.
<p><i>"Equivalent" Y-voltage at generating end of line = 219.5 volts.</i></p> <p><i>Y-voltage at rotary converter = 210.4 volts.</i></p>	Fig. 156.	Fifty per Cent. Overload.
<p><i>"Equivalent" Y-voltage at generating end of line = 219.5 volts.</i></p> <p><i>Y-voltage at rotary converter = 209.5 volts.</i></p>	Fig. 157.	One Hundred per Cent. Overload.

Figs. 153—157 DIAGRAM FOR DETERMINING GENERATOR VOLTAGE AT VARIOUS LOADS.

ELECTRIC RAILWAY ENGINEERING

TABLE LXII.

Variation in Rotary Converter Voltage with Varying Load.

Total resistance per phase = 0·01 ohm.
 Total reactance per phase = 0·01 ohm.
 64 per cent. compounding at full load.
 Adjustment for unity power factor at three-quarter load.
 Equivalent voltage at the generating end of the line = 219·5 volts.

Per cent. of Full Load.	Y Voltage.	Commutator Voltage.
0	213·0	600
25 per cent.	—	—
50	212·3	598
75	212·3	598
100	—	—
125	—	—
150	210·4	592
175	—	—
200	209·5	589

In the same way as for 0·01 ohm reactance per phase, values were obtained for 0·02, 0·03, and 0·04 ohm reactance per phase, all with 0·01 ohm resistance per phase. Then followed corresponding sets of calculations with *resistances* of 0·02, 0·03, and 0·04 ohm per phase. The results of these calculations are given in Table LXIII.

TABLE LXIII.

64 per cent. Compounding at Full Load, Adjustment for Unity Power Factor at Three-quarter Load.

Per cent. of Full Load.	Commutator Voltage.								= Ohm Resistance.	= Ohm Reactance.
	·01	·01	·01	·01	·02	·02	·02	·02		
	·01	·02	·03	·04	·01	·02	·03	·04		
0	600	600	600	600	600	600	600	600		
25 %	—	—	—	—	—	—	—	—		
50 %	598	610	620	632	583	596	609	620		
75 %	597·5	615	631	645	576	594	610	626		
100 %	—	—	—	—	—	—	—	—		
125 %	—	—	—	—	—	—	—	—		
150 %	592	621	650	676	547	578	605	628		
175 %	—	—	—	—	—	—	—	—		
200 %	589	629	665	710	527	564	599	627		
Generated Voltage.	219·5	225·9	232·2	238·6	219·5	225·9	232·2	238·6		

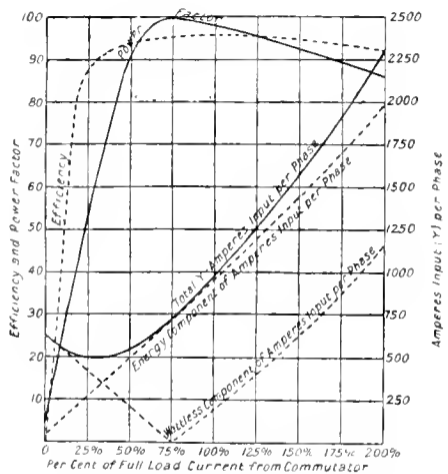

Rotary Converter with 64 per cent. Compounding.

Fig. 152.

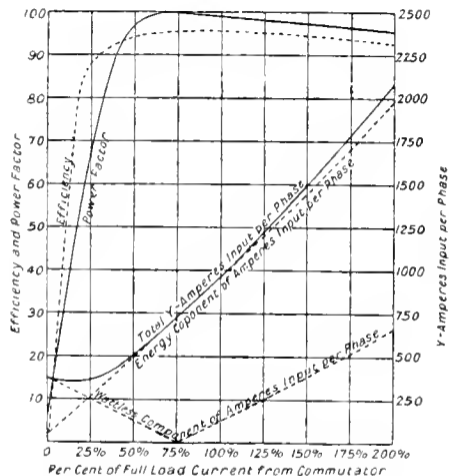

Rotary Converter with 30 per cent. Compounding.

Fig. 158.

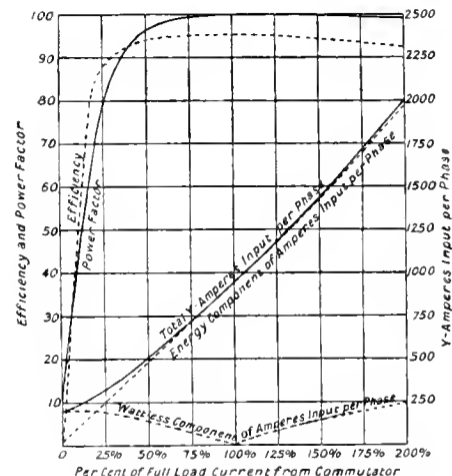

Shunt Wound Rotary Converter (i.e., 0 Compounding)

Fig. 159.

Figs. 152, 158, 159. CURVES OF EFFICIENCY AND POWER FACTOR OF A 600 K.W. ROTARY CONVERTER.

THE SUB-STATIONS

TABLE LXIII.—*continued.*

Per cent. of Full Load.	Commutator Voltage.								Ohm Resistance. Ohm Reactance.
	703		703		704		704		
	01	02	03	04	01	02	03	04	
0	600	600	600	600	600	600	600	600	
25 %	—	—	—	—	—	—	—	—	
50 %	572	579	597	609	560	573	577	590	
75 %	559	570	593	610	540	555	565	582	
100 %	—	—	—	—	—	—	—	—	
125 %	—	—	—	—	—	—	—	—	
150 %	507	531	565	586	465	493	510	534	
175 %	—	—	—	—	—	—	—	—	
200 %	465	495	533	555	402	432	453	475	
Generated Voltage.	220.0	224.8	233.5	239.5	220.8	227.0	231.0	237.8	

The results in Table LXIII. are plotted in the row of curves of Fig. 160, the whole group comprised in this row corresponding to an adjustment for unity power factor at three-quarter load, with 64 per cent. compounding at full load, the total full load excitation thus consisting of

6,000 shunt ampere turns per pole and
3,830 series ampere turns per pole.

The Effect of a Change in the Adjustment of the Compounding.

Suppose the field excitation is so rearranged that it shall at no load give 7,000 ampere turns, at three-quarter load 8,870 ampere turns, and at full load 9,500 ampere turns, there thus being 36 per cent. compounding at full load. This adjustment is indicated by the broken line *cd* in Fig. 151, and corresponds to the values given in Table LXIV. for the amperes input per phase at various outputs, the energy component, the wattless component, the efficiency and the power factor.

TABLE LXIV.

*Rotary Converter adjusted for Unity Power Factor at Three-quarter Load and
36 per cent. Compounding at Full Load.*

Per cent. of Full Load Amperes Output from Commutator.	Commercial Efficiency of Rotary Converter.	Y Amperes Input to Rotary Converter per Phase.	Energy Component of Amperes Input.	Wattless Component of Amperes Input.	Power Factor.	Field Excitation (Ampere Turns per Spool).
0	0 %	380	25	380	0.066	7,000
25 %	88.0 %	370	255	266	0.680	7,620
50 %	94.3 %	500	485	123	0.970	8,250
75 %	95.5 %	720	720	0	1.000	8,870
100 %	96.0 %	983	975	115	0.991	9,500
125 %	95.5 %	1,215	1,190	244	0.980	10,120
150 %	94.8 %	1,490	1,440	388	0.967	10,750
175 %	93.5 %	1,775	1,700	510	0.957	11,370
200 %	92.0 %	2,090	1,980	665	0.946	12,000

ELECTRIC RAILWAY ENGINEERING

The results in Table LXIV. are plotted in Fig. 158 (facing p. 182). A set of results has next been calculated for the performance of the rotary converter with this new adjustment, when operated under the same conditions of reactance and resistance as when adjusted for 64 per cent. compounding. The results are compiled in Table LXV.

TABLE LXV.
36 per cent. Compounding at Full Load, Adjustment for Unity Power Factor at Three-quarter Load.

Per cent. of Full Load.	Commutator Voltage.								= Ohm Resistance. = Ohm Reactance.
	'01	'01	'01	'01	'02	'02	'02	'02	
	'01	'02	'03	'04	'01	'02	'03	'04	
0	600	600	600	600	600	600	600	600	
25 $\frac{\%}{100}$	—	—	—	—	—	—	—	—	
50 $\frac{\%}{100}$	593	600	605	611	579	586	593	601	
75 $\frac{\%}{100}$	589	599	607	617	570	578	587	598	
100 $\frac{\%}{100}$	—	—	—	—	—	—	—	—	
125 $\frac{\%}{100}$	—	—	—	—	—	—	—	—	
150 $\frac{\%}{100}$	578	595	609	622	537	553	565	578	
175 $\frac{\%}{100}$	—	—	—	—	—	—	—	—	
200 $\frac{\%}{100}$	570	587	603	615	509	528	540	551	
Generated Voltage.	216·8	220·6	224·4	228·2	216·8	220·6	224·4	228·2	

Per cent. of Full Load.	Commutator Voltage.								= Ohm Resistance. = Ohm Reactance.
	'03	'03	'03	'03	'04	'04	'04	'04	
	'01	'02	'03	'04	'01	'02	'03	'04	
0	600	600	600	600	600	600	600	600	
25 $\frac{\%}{100}$	—	—	—	—	—	—	—	—	
50 $\frac{\%}{100}$	565	572	580	586	553	560	566	575	
75 $\frac{\%}{100}$	550	560	566	577	530	539	549	557	
100 $\frac{\%}{100}$	—	—	—	—	—	—	—	—	
125 $\frac{\%}{100}$	—	—	—	—	—	—	—	—	
150 $\frac{\%}{100}$	495	512	523	535	454	468	480	493	
175 $\frac{\%}{100}$	—	—	—	—	—	—	—	—	
200 $\frac{\%}{100}$	451	469	480	487	392	406	416	423	
Generated Voltage.	216·9	220·7	224·5	228·3	217·5	220·9	224·8	229·2	

The curves embodying the results of Table LXV. are to be found in the row of curves in Fig. 161, entitled "36 per cent. Compounding."

The Effect of Operating the Rotary Converter with Shunt Excitation alone.

We shall next investigate the action of this rotary converter when shunt-excited, and with 9,000 ampere turns, at full load, this giving unity power factor at full load and 980 amperes input per phase.

THE SUB-STATIONS

The straight line *ef* drawn in Fig. 151 through the points
 9,500 — 210 and
 9,000 — 980

gives, by its points of intersection with the characteristic curves at various loads, the values entered in Table LXVI.

TABLE LXVI.

Rotary Converter with Shunt Excitation,

i.e., with 0 per cent. compounding, and adjusted for unity power factor at full load.

Per cent. of Full-load Amperes Output from Commutator.	Commercial Efficiency of Rotary Converter.	Y Amperes Input to Rotary Converter per Phase.	Energy Component of Amperes Input.	Wattless Component of Amperes Input.	Power Factor.	Field Excitation (Ampere Turns per Spool).
0	0 %	210	25	208	0.119	9,500
25 %	88.0 %	320	255	193	0.797	9,400
50 %	94.3 %	503	485	140	0.965	9,250
75 %	95.5 %	725	720	70	0.994	9,150
100 %	96.0 %	980	980	0	1.000	9,000
125 %	95.5 %	1,195	1,190	80	0.996	8,800
150 %	94.8 %	1,448	1,440	142	0.995	8,600
175 %	93.5 %	1,710	1,700	200	0.994	8,400
200 %	92.0 %	1,995	1,980	245	0.993	8,200

The results in Table LXVI. are plotted in the curves in Fig. 159, from which it is seen that for the rotary converter with shunt excitation there is practically no wattless component available for magnetisation and demagnetisation in regulation.

For a resistance of 0.01 ohm and a reactance of 0.01 ohm per phase, and with 222.6 volts at the generator, the regulation is as follows:—

No load	Commutator voltage = 632
Full load	“ “ = 600
2 × full load	“ “ = 562

For a resistance of 0.01 ohm and a reactance of 0.01 ohm per phase and a generator voltage = 222.6:—

No load	Commutator voltage = 660
Full load	“ “ = 600
2 × full load	“ “ = 557

For a resistance of 0.02 ohm per phase, the values set forth in Table LXVII. were obtained.

TABLE LXVII.

Shunt Excitation and a Resistance of 0.02 Ohm per Phase.

Ohm Reactance per Phase	0.01	0.02	0.03	0.04
Generator Voltage	232	233	234	235.5
Commutator Voltage.				
No Load	663	678	696	725
Full Load	600	600	600	600
1.25 × Full Load	—	—	—	565
1.5 × Full Load	—	—	521	—
1.75 × Full Load	546	527	—	—

ELECTRIC RAILWAY ENGINEERING

The values in Table LXVII. are plotted in the second group of curves of Fig. 162.

The curves in Fig. 163 summarise the results for "64 per cent. compounding," "36 per cent. compounding," and for shunt excitation (*i.e.*, *no compounding*).

Taking the diagrams of Figs. 160 to 163 in *vertical* rows, those at the left correspond to low line resistance; and the further one goes towards the right the greater is the line resistance. The curves of the upper left-hand diagram, where the line resistance is low and the compounding high, are in striking contrast to those lower down and towards the right, where the line resistance is greater and the compounding lower.

The results of this investigation, as brought together in the groups of curves of Figs. 160 to 163, afford ample evidence that only in cases where the distance of transmission is so short, the voltage so high, or the outlay for cables so great that a very low resistance per phase is obtained, can rotary converters be satisfactorily operated for automatic control of the commutator voltage for practically constant voltage at all loads, much less than for 5 per cent. or 10 per cent. higher commutator voltage at full load than at no load. Even with a low resistance per phase, it is necessary to provide large, expensive, and wasteful auxiliary reactance coils in order to obtain satisfactory voltage control by automatic phase adjustment, and for anything more than a very low resistance per phase, there is soon reached a value of the reactance beyond which it is ineffective in producing improved conditions in this respect. In fact, with shunt excited rotary converters, as may be seen from the curves in Fig. 162, and even with a small percentage of series winding, reactance makes the regulation still worse. The curves also show the great importance of a large percentage of series winding from the standpoint of regulation of the commutator voltage by phase control.

It must further be remembered that these estimations have been made upon a rotary converter of very liberal design. From any other standpoint than that of regulation, a much cheaper design would have been permissible, but would, so far as relates to this feature of voltage control, have led to decidedly worse results. In consequence of the absence of armature reaction in rotary converters operated at unity power factor, such a machine should, in the interests of an economical design, be proportioned with a strong armature and with a magnetic circuit of small cross-section; the saturation should also be high, as also the "nominal" current density in the armature conductors, because of the partial mutual neutralisation of the alternating current by the continuous-current components of the total current. All these features have, however, to be partly sacrificed in the interests of phase control. Then, again, the weaker the series winding, the higher is the average power factor of a rotary converter operated in this manner. This may be seen by comparing the curves of Figs. 152, 158, and 159. Thus, again, we see that good automatic commutator voltage regulation by phase control requires a poor power factor at all except a very narrow range of loads.

Practical Application of these Principles.

It should be of interest to apply these principles to a typical case, and as very complete data have been published¹ on the Central London Railway, this installation may be chosen for our purpose.

Owing to the short distance of 6 miles from the power-house to the most remote sub-station, the conditions are especially favourable to a fair showing for rotary converters. The original sub-station installation consisted mainly of six 900-kilowatt

¹ See *Engineering*, February 18th, 25th, and March 4th, 1898; *Electrical Review*, June 1st, 8th, 15th, 22nd, and 29th, 1900.

Fig. 163.

Summary of Results of Figs 15, 16 & 17.

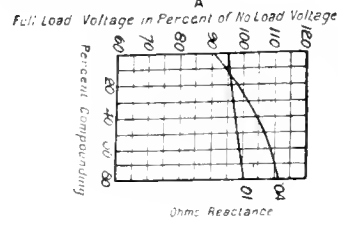

Fig. 162.

Shunt Excitation Only
Unity Power Factor at Full Load.

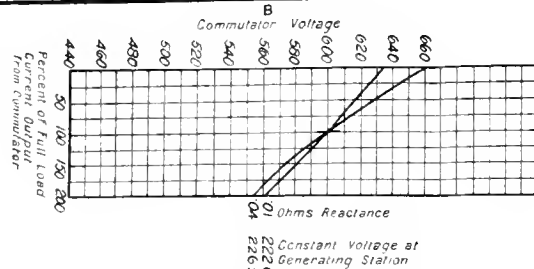

Fig. 161.

36 Percent Compounding
Full Load Excitation = 7000 Shunt Ampere Turns per Pole
& 2500 Series Ampere Turns per Pole

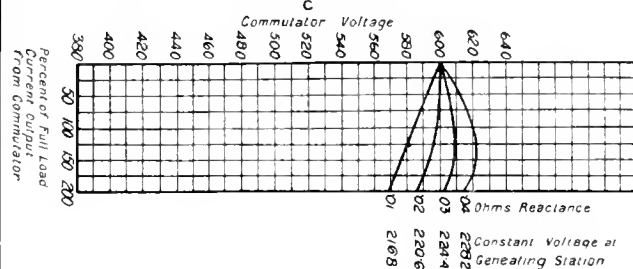
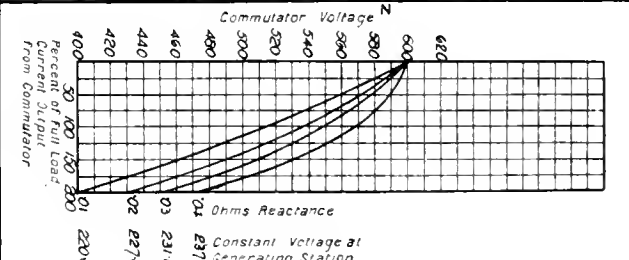
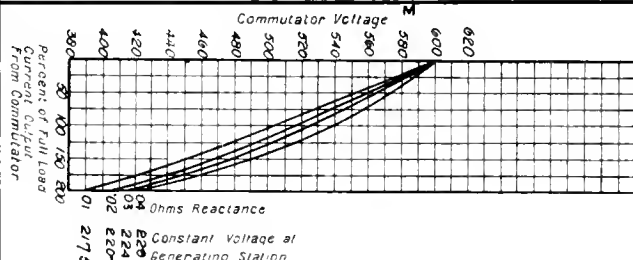
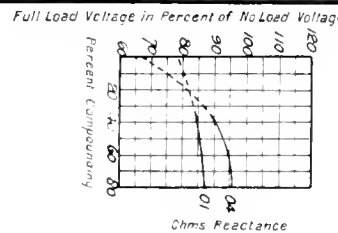
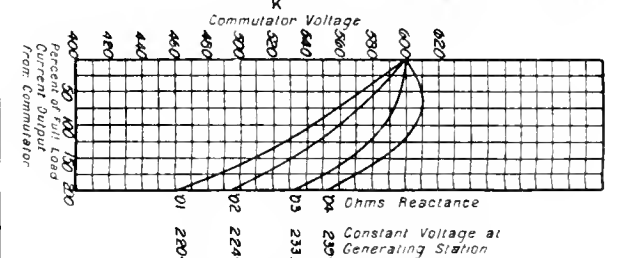
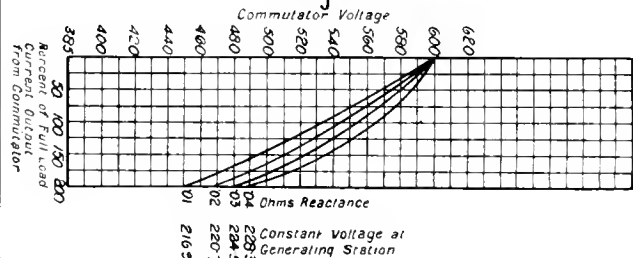
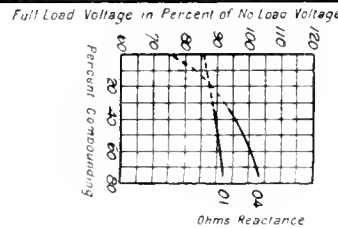
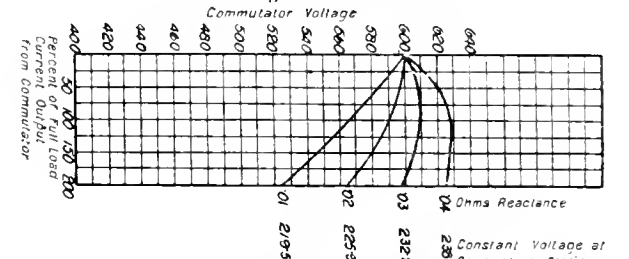
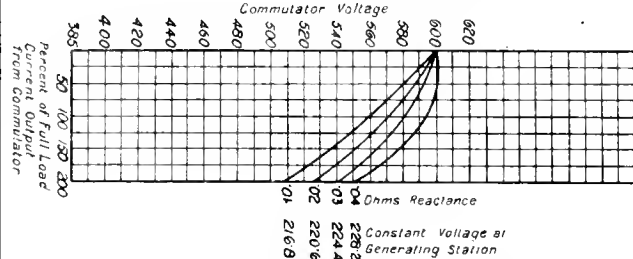
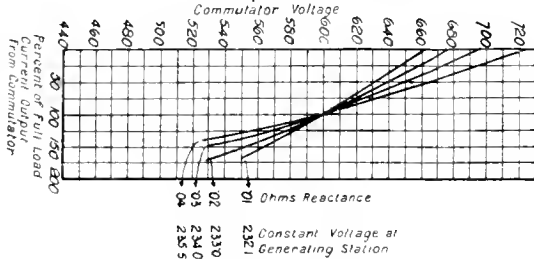
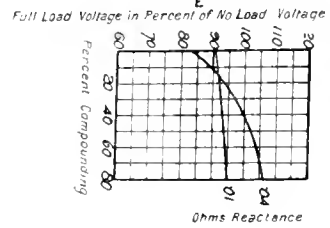
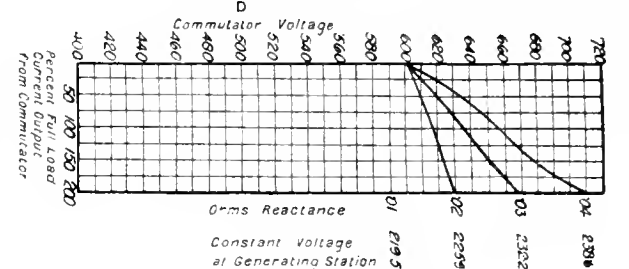

Fig. 160.

64 Percent Compounding
Full Load Excitation = 6000 Shunt Ampere Turns per Pole
& 3830 Series Ampere Turns per Pole.



Resistance = 0.01 Ohm.

Resistance = 0.02 Ohm.

Resistance = 0.03 Ohm.

Resistance = 0.04 Ohm.

THE SUB-STATIONS

rotary converters, twenty-one 300-kilowatt air blast transformers, with blower sets for circulating the air through them, and all necessary switchgear and auxiliary apparatus. These were located in three sub-stations, distant respectively $1\frac{1}{2}$, $3\frac{1}{4}$, and 6 miles from the generating station. The average distance is, therefore, about $3\frac{1}{2}$ miles. The high tension cable equipment for the whole plant comprised 30,500 ft. of lead-sheathed, paper-insulated three-core cables of a cross-section of 0.1875 sq. ins. of copper per core and 64,000 ft. of lead-sheathed, paper-insulated three-core cables of a cross-section of 0.125 sq. in. of copper per core.

Taking the cost¹ of these two cables at £800 per mile and £600 per mile respectively, the total cost is made up as follows :—

Cost for 0.1875 sq. in. cables $\frac{30500}{3250} \times 800$	£1,620
.. .. 0.125 $\frac{64000}{3250} \times 600$	7,380
	£12,000
33 per cent. for connections in power-house and sub-stations ²	4,000
Total outlay for cables	£16,000

or £30 per kilowatt rated output of rotary converters installed.

Take the cost of the rotary converters at £2.5 per rated kilowatt, and of the air blast transformers and ventilating motors at £1 per rated kilowatt, and sub-station switchboards and gear at £1 per rated kilowatt of sub-station.

6 × 900 × 2.5	£13,500 for six rotary converters.
21 × 300 × 1.0	£6,300 for twenty-one air-blast transformers and ventilating motors.
6 × 900 × 1.0	£5,400 for switchboards and gear.

While the above costs are made up from round figures, they are fairly representative of the market prices of that date. If one were to lay out a plant of similar capacity using motor-generators, two-thirds as great total copper cross-section in the cables would be ample, less subdivision of the cables would be necessary, and three independent cables from the power-house would give fully as great security as the four cables employed in the rotary converter installation. Hence the individual cables would have but slightly less cross-sections of copper per core, and the specific cost would be but slightly increased. The cost for cables thus becomes $1.03 \times 0.67 \times 16,000 = £11,000$.

Taking the cost of motor-generator sets as 75 per cent. higher than that of the rotary converters gives

$$1.75 \times £13,500 = £23,600 \text{ for motor-generators.}$$

The transformer item falls out.

The outlay for switchboards and gear may be taken two-thirds as great per kilowatt, since the number of panels, switches, bus-bars, etc., may be greatly reduced and simplified.

$$\text{Outlay for switchboards and gear} = 0.67 \times £5,400 = £3,600.$$

¹ Rough published data for cost of cables may be found in Appendix VIII. of Mr. O'Gorman's paper on the "Insulation of Cables" ("Proceedings of the Institution of Electrical Engineers" (1901), Vol. XXX., p. 680), in Mr. Earle's paper on "The Supply of Electricity in Bulk" ("Proceedings of the Institution of Electrical Engineers" (1902), Vol. XXXI., p. 895), and in Mr. Stewart's paper on "The Influence of Sub-station Equipment on Cost of Electricity Supply" ("Proceedings of the Institution of Electrical Engineers" (1902), Vol. XXXI., p. 1122). See also Chapter VIII., "The High Tension Transmission Line."

² This percentage is high in the case in question, because of the very short distance between sub-stations.

ELECTRIC RAILWAY ENGINEERING

TABLE OF COMPARATIVE COSTS.

	Rotary Converters.	Motor- Generators.
High tension cables	£16,000	£11,000
Rotary converters	13,500	—
Motor-generators	—	23,600
Step-down transformers and ventilating sets	6,300	—
Sub-station switchboards and gear . . .	5,400	3,600
	£41,200	£38,200

Whether the interest on this 7 per cent. less outlay for the motor-generator scheme would offset the 3 per cent. to 6 per cent. lower efficiency of operation would require a careful analysis of the operating costs.

Moreover, it is highly probable that a still less proportional initial outlay for cables would be permissible with motor-generators, if the interest on the saving justified the decreased economy in operation. The cross-section of cables, so far as reliability in service is concerned, would be determined from the point of view of the permissible current density, or rather the permissible heating, and not from that of the permissible drop.

It is by no means intended here to assert that in the Central London plant the use of motor-generators would have led to ultimate higher earning capacity; but so much data has been given to the public on this particular plant as to permit of a fair comparison on the basis of published data. It serves to illustrate the basis on which a comparison should be made, and shows that with longer systems, requiring a greater proportional outlay for high tension cables, the balance tends towards showing an economic advantage to be gained by the use of motor-generators.

To emphasise the importance of these considerations we propose to describe the case of an extensive tramway plant in a large city in South America in which the high tension cables installed were utterly inadequate for permitting of good automatic regulation of the voltage at the commutators of the rotary converters installed at the more distant sub-stations. The plant was provided with three sub-stations, A, B, and C, and the installation of rotary converters and cables, and the distances from the power-house to each of the sub-stations are set forth in Table LXVIII.

TABLE LXVIII.

Some Data of a Rotary Converter Installation.

	A	B	C
Designation of sub-station	A	B	C
Number of 400-kilowatt rotary converters at each sub-station	3	3	3
Number of rotary converters to be considered as reserve	1	1	1
Number of three-core high tension (6,650-volt) cables .	2	2	2
Cross-section per core, square millimetres	30	30	30
Length of each cable, metres	3,400	5,900	8,300
Length of each cable in miles	2.11	3.66	5.15
Resistance per core at 15 degrees Centigrade in ohms .	1.92	3.34	4.69

The regulation was calculated for sub-stations A and C (*i.e.*, for the nearest sub-station and for the most distant), under the assumption in each case that both cables in the sub-station were in service, that two out of the three rotary converters

Sub-station A.
(Newport Sub-station.)

Rotary Converter Regulation Curves.

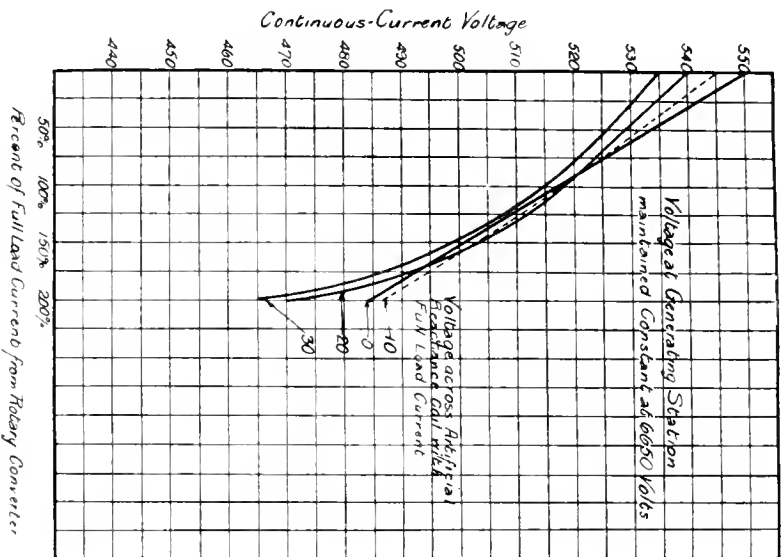

Fig. 164.

Sub-station C.
(Parthust Sub-station.)

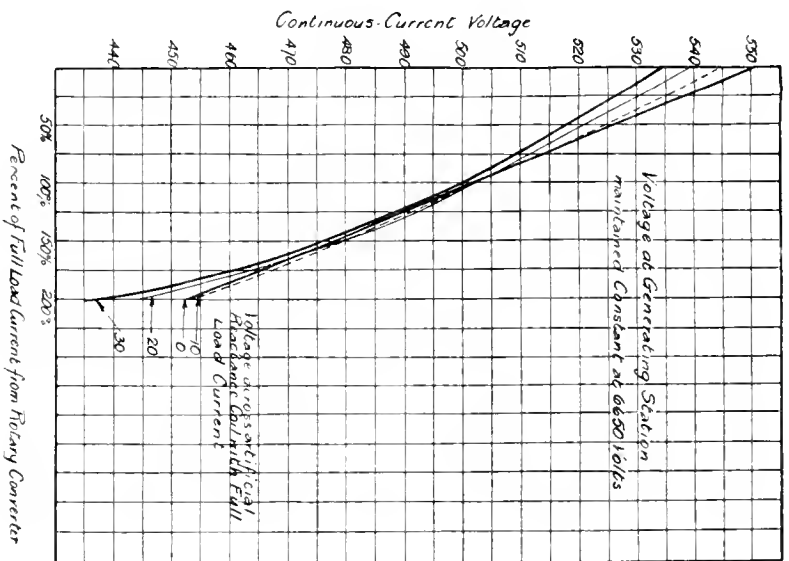

Fig. 165.

Full Load Voltages at Commutators of Rotary Converters.

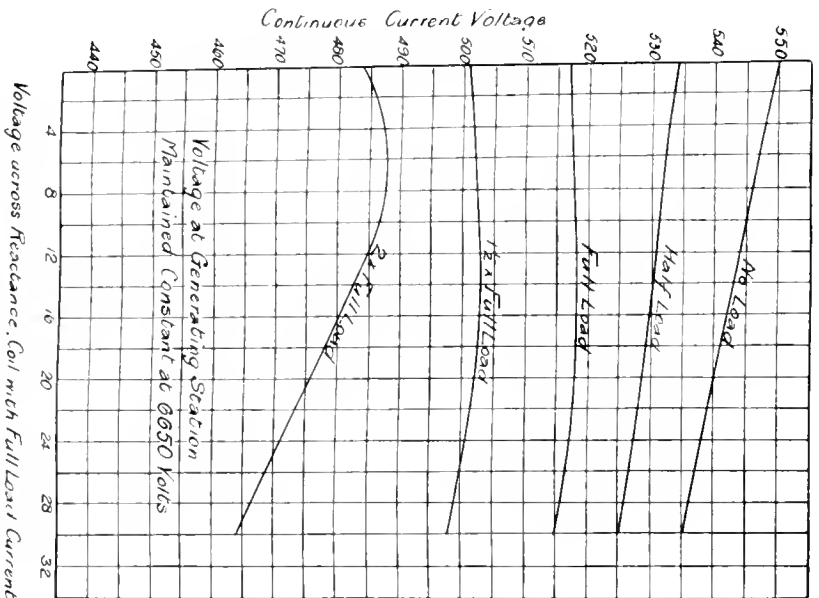

Fig. 166.

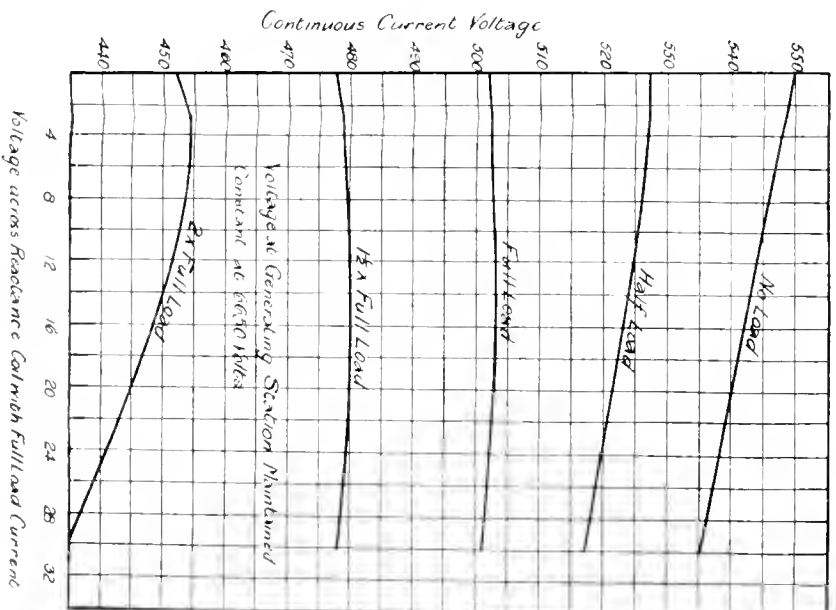

Fig. 167.

THE SUB-STATIONS

at each sub-station were running, and that the voltage at the generating station was maintained constant at 6,650 volts.

In Figs. 164, 165, 166, and 167 the results have been plotted in curves.

From these curves we see the futility of employing reactance coils in this case to improve the regulation.

The compounding of the rotary converters had been proportioned so that at rated load some 25 per cent. of the excitation was supplied by the series coils. The observed and calculated no-load and full-load phase characteristics of the rotary converters are given in the curves of Fig. 168. A higher percentage of series winding ought to have been employed at any rate in the rotaries in the most distant sub-station, and at that sub-station a lower ratio of transformation in the step-down transformers would have been preferable. The only *radical* remedy for such a case, however, consists either in substituting motor generators or in greatly increasing the equipment of high tension cables.

From the standpoint of capital outlay, designs for each of these two plans should have been prepared and compared.

In an article contributed to *The Electrical Review*,¹ one of the present writers expressed himself on this question as follows:—

“A good deal has been written on subjects relating to the relative merits of rotary converters and motor-generators, low-speed and high-speed engines, and on parallel running. The three questions have a more decided bearing upon one another than appears to be realised. In fact, while the present article deals with no strictly new idea, it has been written as

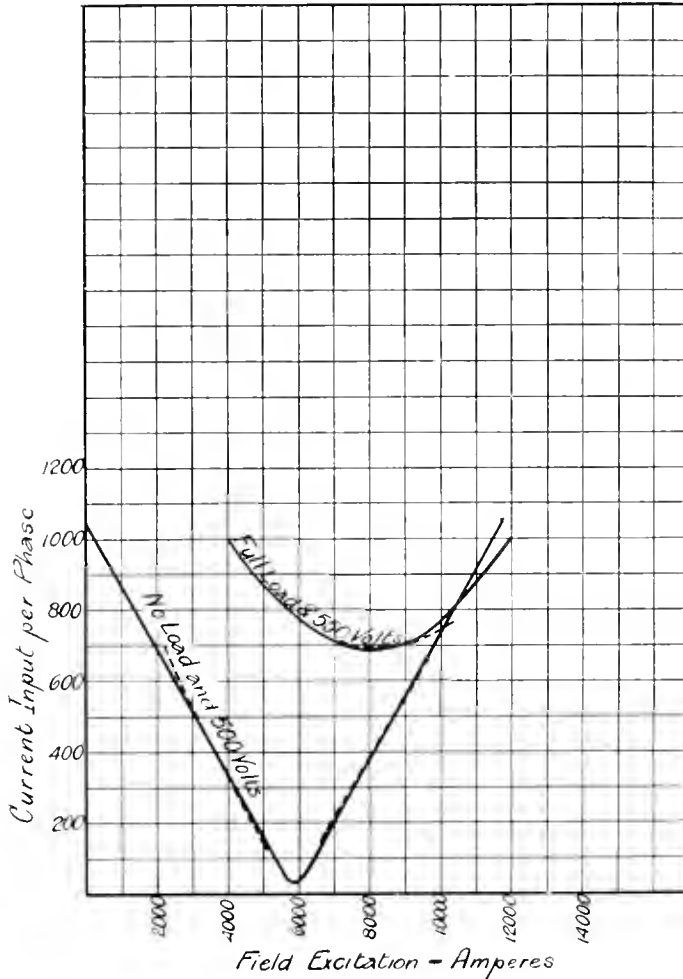

Fig. 168. 100-K.W. ROTARY CONVERTER CHARACTERISTIC PHASE CURVES.

Full line curves = Calculated values. Dotted line curves = Observed values.

¹ “Choice of Type and Periodicity for Electric Traction Plant” (H. M. Hobart); *Electrical Review*, May 24th, 1901, p. 872.

ELECTRIC RAILWAY ENGINEERING

the result of a conviction that the logical consequences of the experience of the last few years in these matters, have not yet been clearly appreciated. Though many writers bring out interesting and useful conclusions, all seem to have missed the main point.

“ Polyphase transmission systems with rotary converter sub-stations have now been installed in large numbers and operated with very gratifying results. Whatever considerable difficulties have been met with in their operation, have been attributable to lack of sufficiently uniform angular velocity in the prime movers. The writer quite disagrees with a current opinion that “ hunting ” difficulties in rotary converters are ever due to causes other than those originating in this lack of perfectly uniform angular velocity in the prime movers: at any rate, any other causes are of the most subordinate importance. Given a uniform angular rotation of the generators, the way is perfectly clear for entirely satisfactory operation of the rotary converters without any damping or other equivalent auxiliary devices. A consideration of the matter of obtaining sufficiently close phase regulation in the generators, leads to the following observations:—

“ Two entirely different classes of generating plant are at present being advocated by engineers, and there is not the slightest likelihood that within less than several years electrical manufacturers will be relieved from the necessity of supplying apparatus of two altogether different types. These two types are respectively those for high-speed and those for low-speed engines. Take as a representative instance the case of a central station to be equipped with several 1,000-h.p. units. In the one case these will be arranged to run at, say, 250 revolutions per minute, in the other at about 83 revolutions per minute. In the former case the problem of operating rotary converters satisfactorily is greatly simplified. The customary lowest limit for the periodicity is 25 cycles per second. This—for the speed assumed—requires but 12 poles. A further customary requirement is that the phase deviation from perfect uniformity shall never exceed 2·5 degrees, or 0·7 per cent. Hence the displacement in space from the positions corresponding to absolutely uniform angular rotation must not exceed $0\cdot7 \frac{\text{per cent.}}{6} = 0\cdot12$ per cent. of the entire circumference. With an engine

exerting a fairly uniform turning moment, and at the relatively high speed of 250 revolutions per minute, this should not require an excessively large fly-wheel. The case would be very different for the low-speed generator. At 83 revolutions per minute 36 poles would correspond to 25 cycles per second, and the angular deviation from uniformity would have to be less than 0·04 per cent., which for the low speed of 83 revolutions per minute would, for the best of such engines, require a tremendous fly-wheel. In practice a less close degree of regulation would probably be decided upon, and the rotary converters would be made to run satisfactorily by wrought-iron pole-faces, damping plates, or pole-face damping windings, or the generators might be equipped with similar devices. But these will not result in so satisfactory working as would be the case with a plant in which no such troublesome tendencies exist. Moreover, at least 1 per cent. or 2 per cent. of energy would doubtless be dissipated in such devices. For the low-speed plant the writer would be inclined to lower the periodicity to, say, one-third of the present customary minimum value—*i.e.*, to $8\frac{1}{3}$ cycles per second, and to employ generators with but 12 poles. At this low periodicity, step-down transformers would be very expensive, and the writer would abandon rotary converters and equip the sub-stations with 6-pole high potential synchronous motors running at 165 revolutions per minute, direct connected to

THE SUB-STATIONS

first-class 600-volt railway generators. The lower efficiency of such a set—as compared with step-down transformers and rotary converters—would be so nearly offset by the decreased energy requiring to be expended in devices for overcoming hunting, as to bring the commercial efficiencies of the two plants within 2 per cent. or 3 per cent. of one another. It must also be remembered that there are two distinct difficulties thus overcome, or at least greatly modified—first, the paralleling of the generators with one another; and, secondly, when that is successfully accomplished, it still remains an open question whether the combined parallel running is sufficiently free from angular deviations to deliver satisfactorily constant periodicity to the rotary converters. The writer agrees with the views of some other engineers that it is open to question whether the most liberal of fly-wheels will necessarily lead to satisfactory parallel running of the generators. Quite contrary, however, to the general opinion, the writer believes that the larger the momentum of the rotor of the rotary converter, the more independent will it be of these disturbing tendencies. This latter opinion, however, does not affect the conclusions reached in the present article.

“Of the higher cost of sub-station motor-generators as compared with step-down transformers and rotary converters, it may be said that the great simplification in switch-board apparatus, the less need for close regulation in the high tension mains, the dispensing with all auxiliary devices required for voltage adjustment and the far less skilled attendance required, will largely or altogether offset the difference in cost. Moreover, the railway generator employed in the sub-station would be of the normal construction best suited for the requirements, and such a machine of the highest grade may, owing to standardisation and keener competition, be obtained from the manufacturers at a cost much less in excess of that of a rotary converter than that represented by the intrinsic values of material and labour in the two machines.

“In concluding, the writer would sum up his opinion as follows:—For future traction projects, the rotary converter should be superseded by the motor-generator, and the periodicity should be still further lowered for the case of very slow-speed steam engines: but it may often still be advantageous to employ rotary converters, and at 25 cycles per second, for plants where the generators are direct connected to high-speed engines.”

Subsequent events have slowly led up to a more general recognition of the correctness of this standpoint than was obtained at the time of writing.¹

THE USE OF ACCUMULATORS IN SUB-STATIONS.

For working in parallel with rotary converters, some different considerations arise from the case of working in parallel with generators.

In Germany, accumulators have been widely used in parallel with shunt generators for tramway plants, the characteristic of the generator falling preferably a great deal more than the battery characteristic.

But the conditions corresponding to the operation of rotary converters in sub-stations, require for most satisfactory results, a reasonably good regulation. Thus one rarely permits in the high tension cables, more than 5 per cent. drop on the maximum probable load, and only by resorting to line and transformer reactance, potential regulators, Alioth device, etc., can one vary materially the commutator voltage of the rotary converter. This is leading, in France and America, to the

¹ See contributions by Eborall in reply to this article: *Electrical Review*, June 7th, 1901, p. 963, and June 14th, 1901, p. 1009.

ELECTRIC RAILWAY ENGINEERING

gradual introduction as a standard system, of employing a compound-wound booster in series with the battery in parallel with the rotary converter. The battery and compound-wound booster in series have a resultant characteristic approximately a straight line, *i.e.*, they have the same terminal voltage for all values of the charging and discharging current, and hence a comparatively trifling inherent drop in a shunt-wound rotary converter suffices to permit of adjustments such that the system regulates automatically, and the rotary converter delivers a constant load, which, according to the conditions from instant to instant in the circuit supplied, goes, either partly or wholly, directly to this circuit, or is devoted to charging the battery. The voltage is furthermore automatically maintained constant.

In such a system the variations in load on the generating station would generally not much exceed 10 per cent.; hence one would at any time place in service only a sufficient number of generating sets to carry the average load at their most efficient point of working. Hence the generators would only require to have an overload capacity of about 25 per cent. for an hour or so, this being a very different state of affairs from supplying generating sets capable of carrying a load rapidly fluctuating in the ratio of one to two, or even more. In the same way the rotary converters are supplied on the basis of only a safe margin above constant average load.

The high tension cables also only require to be large enough to have the prescribed drop at *average* instead of *maximum* load, and this introduces a very great saving.

But it is fallacious to look for good results from this system under any other conditions than that a very liberal storage battery be installed, this not with the object of using it up to anywhere near its rated capacity, but, in the first place, in recognition of the fact that batteries still deteriorate, even with the best of handling, much more rapidly than at the guaranteed rate, in the second place, in order to secure thoroughly good voltage regulation, and, in the third place, to thus have for a short time, independently of the dynamo-electric machinery, a source of supply ample for handling the entire load. With anything less than this, one is obliged to provide spare sets to almost the same extent as for a system without accumulators.

Take a case for illustration:—

Suppose a sub-station is required for furnishing a 600-volt load having peaks touching a maximum of 2,500 amperes, but having an average load of only 1,000 amperes. In this sub-station should be installed three 400-kilowatt rotary converters, one being spare, and an accumulator for 2,000 amperes for 1 hour. Only in the remotely possible case of an accident during time of heavy service shutting down the central station generators would there be any probability of drawing more than 75 per cent. rated discharge current from the battery, and even the entire load of 2,500 amperes is but 25 per cent. in excess of the rated discharge current. Normally the rotary converters would be adjusted to deliver 75 per cent. of their full load of 1,330 amperes, *i.e.*, 1,000 amperes, constantly, the battery receiving part of this whenever the load falls below the average, and the battery supplying the peaks in parallel with the rotary converters. Hence the battery is never charged at a higher rate than 1,000 amperes (its normal charging rate is $0.6 \times 2,000 = 1,200$ amperes), and at this rate of 1,000 amperes only when the external load is zero, which, of course, practically never occurs. The battery never discharges at a higher rate than 1,500 amperes, and this only for the most extreme peaks of the load. The booster would not be proportioned for 2,000 amperes—the battery's rated discharge current—but for a maximum of 1,500 amperes: for in the

THE SUB-STATIONS

ease of a disaster requiring the temporary shut-down of the central station, the booster would also shut down, and the battery would temporarily supply the line direct, sometimes at a somewhat reduced voltage according to the state of charge.

Then, if the accumulator should be out of service, the three rotary converters would be required to handle the load, and could do it, as their normal rated capacity is $3 \times 666 = 2,000$ amperes, and the maximum peaks do not exceed 2,500 amperes.

Another advantage of this larger accumulator, is that its internal resistance is lower: hence for the loads at which it will be operated, its regulation and its efficiency are better; also somewhat less voltage is required of the booster (which makes up for the internal drop in the battery and in itself), and the boosters may be a trifle smaller.

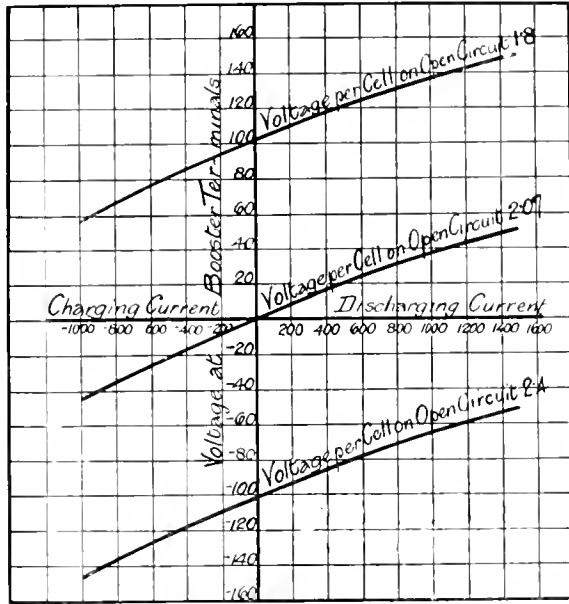

Fig. 169. BOOSTER VOLT-AMPERE CHARACTERISTIC CURVES.

Unless, on comparative calculations, a plant, even with such a liberally proportioned accumulator, shows increased economy, considering both first cost, maintenance, and operating costs, no accumulator should be used, but the system should instead consist of generating sets with ample spares, and high overload guarantees, and the equipment of high tension cables and of rotary converters (which latter should be compound-wound) should be proportionally liberal.

But in the event of there being evident economy in spite of the liberal proportions of the battery, it will be of interest to map out the system a little more in detail:—

A representative 2,000-ampere cell will have, when used as a buffer battery for 1,500 amperes, a voltage ranging from 2.4 when fairly charged, down to 1.8 at fairly low charge; the average may be taken at 2.05 volts.

We should instal $\frac{600}{2.05} = 294$ cells.

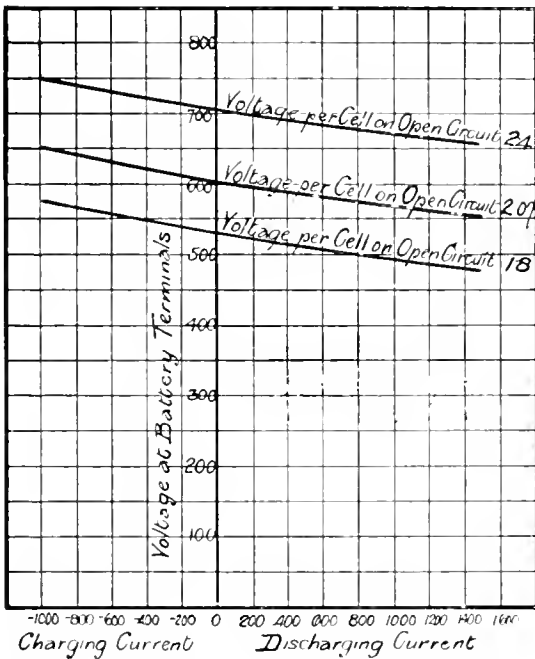

Fig. 170. BATTERY VOLT-AMPERE CHARACTERISTIC CURVES.

THE SUB-STATIONS

characteristics, which are given in Fig. 170, give a practically constant voltage across battery-plus-booster, of 600 volts.

The plan described makes use of the pure compound-wound booster. A number

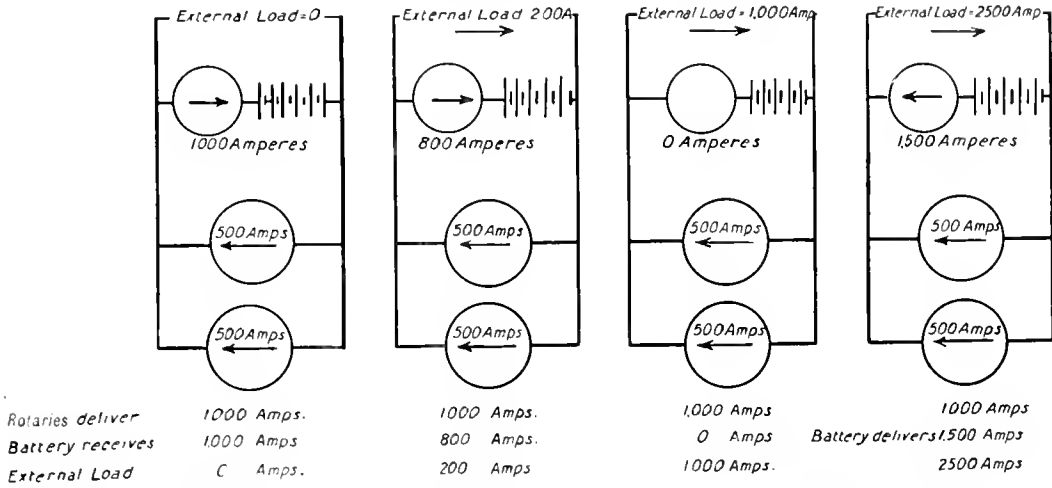

Fig. 173. DIAGRAMS SHOWING SUBDIVISION OF THE CURRENT BETWEEN ROTARIES AND BATTERY.

of very excellent and advantageous modifications are often employed. These are very thoroughly described in a series of articles in the *Electrical World and Engineer* (New York) for June 8th, 15th, 22nd, 29th, and July 6th and 13th, 1901. The articles are by Lamar Lyndon, and are entitled "Storage Battery Auxiliaries." Of these the first four articles are the more important as relating to possible use in traction work.

But inasmuch as a rotary converter sub-station in its simplest form has already a good many necessary connections and switches, it would not appear desirable, if a booster battery set is added, to bring in any but the most simple form. The connections corresponding to this form are shown in Fig. 171.¹

In Fig. 172 are given curves representing the voltage regulation of the rotary converter and of the battery, with booster for varying currents on each.

The diagrams in Fig. 173 show

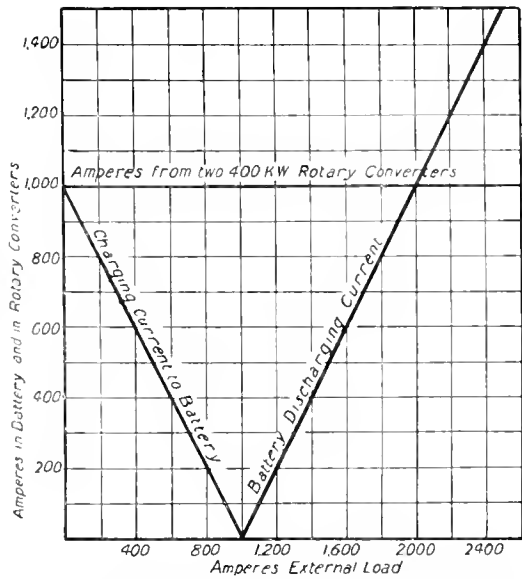

Fig. 174. CURVES SHOWING DISTRIBUTION OF LOAD BETWEEN ROTARIES AND BATTERY-BOOSTER.

¹ There is amongst those described in Lyndon's articles one especially interesting method covered by Hubbard's United States Patent 651,664 (1890), so devised that, above a certain limit, excesses of load are taken by the generator instead of by the battery. It would appear that this would probably act too sluggishly to protect a battery in rapidly changing traction loads.

ELECTRIC RAILWAY ENGINEERING

the subdivision of the current between the two 400-kilowatt rotary converters and the 2,000-ampere-hour battery.

The arrangement gives constant potential of 600 volts at the continuous current load for all values of the load.

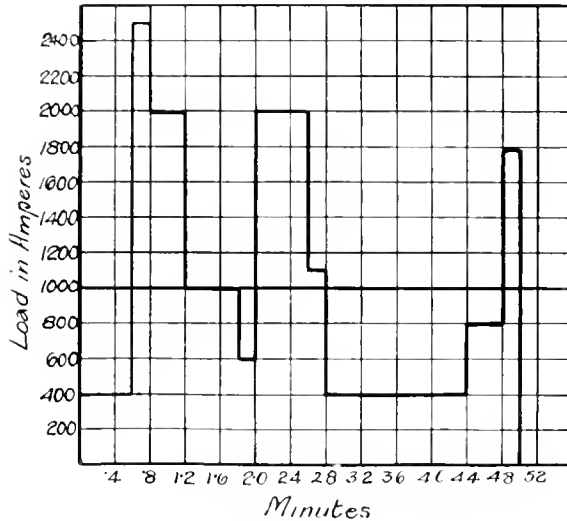

Fig. 175. FIVE MINUTES LOAD CURVE.

(assumed merely for illustrative purposes) for 5 minutes, averages 1,000 amperes. Table LXIX. gives the amperes during each 0.2 minute (*i.e.*, each 12 seconds), in rotary converter and in battery.

$$\text{Average amperes} = \frac{14,800}{2.5} = 590 \text{ flowing into, or out of, battery and booster.}$$

Hence during these 5 minutes there have been sent into the battery $\frac{7,400}{2.5 \times 12} = 247$ ampere hours; *i.e.*, in an hour $12 \times 247 = 296$ ampere hours. The same amount was taken out. This is equivalent to current flowing through the battery at the rate of about 600 amperes. The apparent internal resistance (averages of charge and discharge) equals 0.039 ohm. $I^2 R$ loss = 14,000 watts. Increase this to 17,000 watts to include all further losses in battery at this current.

The booster installed will be for a *maximum* capacity of $150 \times 1,500 = 225,000$ watts or 225 kilowatts; but as this is the *maximum*, it will be designed for a maximum efficiency at about half-load, say 800 amperes and 130 volts. The efficiency of a set working under such widely varying conditions, will not be high; it may be taken at 80 per cent. for all loads to which it is subjected for any length of time, although in fact this will vary through the range from 60 per cent. to 90 per cent.

As the load on the rotary converter is constant, its efficiency may be taken at 94 per cent.

Of the average current of 1,000 amperes going to the load, 300 amperes only reaches the load after passing into, and out of, the storage battery and booster.

¹ Sudden sharp peaks of load would *tend* to be taken by the *rotary converter*, because the inductance of the booster series field makes it act somewhat sluggishly. This is an advantage, as tending to protect the battery from momentary high loads. The tendency may be increased by introducing additional reactances in the booster circuit.

THE SUB-STATIONS

Assume that the booster is traversed by its average 600 amperes at a terminal voltage of 75. (This voltage varies widely according to the state of charge.)

$$75 \times 600 = 45,000 \text{ watts.}$$

At 80 per cent. efficiency this corresponds to 11,300 watts lost in booster.

$$\text{Booster loss} = 11,300$$

$$\text{Battery loss} = 17,000$$

$$\text{Total} \quad 28,300$$

TABLE LXIX.

Distribution of Current in Rotary Converter and Battery for a Period of Five Minutes.

Time in Minutes.	Amps. from Rotary Converter.	Amps. into Battery.	Amps. out of Battery.
0	1,000	600	0
.2	1,000	600	0
.4	1,000	600	0
.6	1,000	0	1,500
.8	1,000	0	1,000
1.0	1,000	0	1,000
1.2	1,000	0	0
1.4	1,000	0	0
1.6	1,000	0	0
1.8	1,000	400	0
2.0	1,000	0	1,000
2.2	1,000	0	1,000
2.4	1,000	0	1,000
2.6	1,000	0	100
2.8	1,000	600	0
3.0	1,000	600	0
3.2	1,000	600	0
3.4	1,000	600	0
3.6	1,000	600	0
3.8	1,000	600	0
4.0	1,000	600	0
4.2	1,000	600	0
4.4	1,000	200	0
4.6	1,000	200	0
4.8	1,000	0	800
		<hr style="width: 10%; margin: auto;"/>	
		7,400	7,400

The total output from the two rotary converters, with its constant load of 1,000 amperes, is 600 kilowatts. This, at 94 per cent. efficiency, corresponds to 638,000 watts input and to 600,000 — 28,300 = 571,700 watts delivered from the sub-station.

ELECTRIC RAILWAY ENGINEERING

Hence the net efficiency is $\frac{571.7 \times 100}{638.0} = 89.4$ per cent., say 89 per cent., as against the 94 per cent. that it would have been without the extra transformation.

But, with the widely varying loads occurring in sub-stations with compound-wound rotary converters and no accumulators, the average efficiency could not be expected to exceed 92 per cent. when the converter's full load efficiency is 95 per cent.

These 294 cells would not be supplied for less than £8,000.

Accumulator	£8,000
Booster	1,000
Three 400-kilowatt rotaries at £900 each	2,700
Ten static transformers at £350 each	3,500
Switchboard, wiring, cables, and all other accessories in sub-station	1,000
Sub-station building	1,500
	<hr style="width: 100%;"/>
Complete cost per sub-station	£17,700
	<hr style="width: 100%;"/>

We must make a comparative estimate of the cost of all those amongst the above items which will be chosen differently according to whether an accumulator is or is not employed. This will require figures for the high tension transmission line and for the power-house and equipment.

Assume five sub-stations, such as that described, each 6 kilometres distant radially from a central power-house. Each sub-station is loaded, as in the case described, with 1,000 average amperes and 2,500 maximum amperes; in fact, we may assume for each a load curve equal to that already given. Take the transmission as three-phase with 6,500 volts between cores, or 3,750 volts per phase.

For the accumulator project:—

Permit 3 per cent. loss in high tension cables corresponding to average load.

Average load = $5,000 \times 600 = 3,000$ kilowatts.

Efficiency of sub-station transformation (including step-down transformer) = $0.97 \times 0.89 = 0.864$.

Hence generating station output = $3,000 \times \frac{1.03}{0.864} = 3,580$ kilowatts, or 1,200 kilowatts per phase.

Amperes per phase = 320.

Amperes per core of each of the five three-core cables = 64.0.

Volts drop per core = 113. volts.

Resistance per core = 1.76 ohms, or 0.294 ohm per kilometre.

This corresponds to a cross section of 58. sq. mm. per core and a weight of 517. kilogrammes of copper per kilometre per core.

Now in all three cores of all five cables there are $3 \times 5 \times 6 = 90$ kilometres, hence 46,500 kilogrammes of high tension copper.

Estimating the cost of the complete cable, laid and jointed, at 7.50 shillings per kilogramme of contained copper, we arrive at a total cost for high tension cables, of
£17,500.

In the power-house should be installed four 1,300-kilowatt, 5,000-volt, 25-cycle, 94-r.p.m., three-phase generating sets, one being a spare. They must be guaranteed on the basis of carrying satisfactorily about 25 per cent. overload for half an hour. Estimate these generators at £3,000 each and the engines at £6,000 each.

THE SUB-STATIONS

Central Station :—

Building	£20,000
Boilers, pumps, piping, etc.	12,500
Exciter sets, switchboards, and cables	4,000
Four 25-cycle, 5,000-volt, 94-r.p.m. three-phasers	12,000
Four engines for direct connection to above	24,000
Total, Central Station	72,500
High-tension cables	17,500
Five sub-stations at £17,700	88,500
Total	£178,500

Without accumulators :—

Should require four 500-kilowatt rotaries instead of three of 400-kilowatt output.

Four 500-kilowatt rotaries	£4,000
Fifteen static transformers	5,000
Switchboard, wiring, cables, and all other accessories in sub-station	1,000
Sub-station building	1,300
Complete cost for sub-station	£11,300

The high tension cables must in this case be large enough to carry the *maximum* load of 2,500 amperes with only 4 per cent. drop. Hence $\frac{3}{4} \times \frac{2,500}{1,000} \times 46,500 = 87,000$ kilogrammes of copper.

Estimating on the cost of the complete cable, laid and jointed, at 6 shillings per kilogramme of contained copper, we arrive at a total cost for high tension cable of
£26,000.

In power-house, two more generating sets would be ample, as the peaks would not come simultaneously on all five sub-stations.

Hence —

Central Station :

Building	£22,500
Boilers, pumps, piping, etc.	18,800
Exciter sets, switchboards, and cables	5,000
Six 25-cycle, 5,000-volt, 94-r.p.m. three-phasers	18,000
Six engines for direct connection to above	36,000
Total, Central Station	100,300
High tension cables	26,000
Five sub-stations at £11,300	56,500
Total	£182,800

Suppose we take as the average efficiency of the sub-station from incoming high tension cables to outgoing low tension cables, including step-down transformers,

$$\text{With accumulators} \quad 0.89 \times 0.97 = 0.864,$$

$$\text{Without} \quad \dots \quad 0.92 = 0.96 = 0.884$$

(0.96 being taken for variably loaded transformers against 0.97 for transformers with constant load).

ELECTRIC RAILWAY ENGINEERING

We have taken the average loss in the high tension cables at 3 per cent. with accumulators, and the loss with maximum (peak) of load at 4 per cent. without accumulators, hence $\frac{1,000}{2,500} \times 4 = 1.6$ per cent. *average* loss.

Hence the average efficiency from beginning of high tension transmission lines to beginning of low tension lines is

$$\begin{array}{ll} \text{With accumulators} & 0.864 \times 0.970 = 83.6 \text{ per cent.}, \\ \text{Without} & 0.884 \times 0.984 = 87.0 \text{ per cent.} \end{array}$$

There remains to compare the annual running cost and interest and depreciation on the capital outlay.

With Accumulators.

The generating plant delivers, for 20 hours per day, a constant load of 3,600 kilowatts at the point of maximum economy of the steam engines. Under such conditions we may take the cost for coal, oil, repairs, staff (but exclusive of amortisation), at 0.7*d.* per kilowatt hour. Hence the annual running cost is

$$\frac{365 \times 20 \times 3,600 \times 0.7}{240} = \text{£}7,700.$$

The plant cost (*i.e.*, the portion compared) already worked out above is
£178,500.

This, at 5 per cent. interest, represents an annual expense of $0.05 \times \text{£}178,500 = \text{£}8,900$.

Of this £178,500 value of plant, the accumulators represent $5 \times \text{£}8,000 = \text{£}40,000$, and the annual depreciation should be taken at 10 per cent., *i.e.*,

$$\text{Annual depreciation of accumulators} = \text{£}4,000.$$

On the balance of $\text{£}178,500 - 40,000 = \text{£}138,500$, the depreciation should be estimated at 5 per cent., giving

$$\text{Annual depreciation on balance at 5 per cent.} = \text{£}6,900.$$

Total depreciation on the £178,500 = $4,000 + 6,900 = \text{£}10,900$.

Summary for plant *with* accumulators:—

Running cost	£7,700
Interest on value of plant	8,900
Plant depreciation	10,900
Total annual cost	£27,500

Without Accumulators.

The efficiency from the beginning of the high tension transmission lines to the beginning of the low tension lines has been shown to be 87.0 per cent., as against 83.6 per cent. with accumulators. Hence the generating plant is only required to deliver an average load of

$$\frac{83.6}{87.0} \times 3,600 = 3,460 \text{ kilowatts.}$$

But this, instead of being constant, may be taken as varying frequently from 2,500 kilowatts to 4,300 kilowatts. Under these conditions the same coal economy cannot be obtained, and we will take the cost per kilowatt hour at 0.8*d.*, as against 0.7*d.* for constant load. Hence the annual cost is

$$\frac{365 \times 20 \times 3,460 \times 0.8}{240} = \text{£}8,400.$$

THE SUB-STATIONS

The plant cost (*i.e.*, the portion compared) is

£182,800.

and at 5 per cent. interest represents an annual expense of

$$0.05 \times 182,800 = \text{£}9,100.$$

The depreciation, on a 5 per cent. basis, is also £9,100.

Summary for plant *without* accumulators:—

Running cost	£8,400
Interest on value of plant	9,100
Plant depreciation	9,100
	£26,600
Total annual cost	£26,600

Hence the comparative total costs are—

With accumulators	£27,500.
Without	£26,600.

the results only differing by about 3 per cent., which on the total annual cost, including low tension network, trains, wages, administration, etc., would make a negligible difference between the two systems.

There is also but little to choose between the two systems from the standpoint of regulation, and nothing from that of reliability of service.

From the standpoint of attendance, however, the plant employing accumulators would be at a disadvantage. It is doubtful if many engineers with long experience of accumulators, and with open minds, would advocate the plant employing accumulators, unless they could thereby obtain better financial results.

Accumulator advocates will protest against the assumption of 10 per cent. annual depreciation as being too high. It is, on the contrary, much lower than is generally obtained in practice.

Before leaving the subject of storage batteries as relating to electric railway engineering, it may be well to give the substance of a brief comparison once made by one of the present authors, of the prices of storage batteries in Germany, England, and America. While prices have tended downward since the time that this comparison was made, it is believed that the data will nevertheless be of value in investigating the relative merits of plants with and without batteries.

Tables LXIXA. and LXIXB. were prepared from data and curves given in a paper by Highfield, read before the Institution of Electrical Engineers, on the 9th of May, 1901 (Proceedings, Vol. XXX., page 1046).

In general, the data given in these tables, which one ought to be able to take as a guide to storage battery prices in England, are, in agreement with other available data on storage battery costs in England, much lower than the costs in America and much higher than the costs in Germany. Thus, in a paper by Grindle, before the Institution of Electrical Engineers, February 26th, 1901, there occurs the following statement:—“ . . . by employing a battery to deal with the demand over and above the mean load, it will require that there shall be installed, a battery capable of delivering, as a maximum, 300 kilowatts. The cost of a battery to comply with these conditions would approximate somewhere about £12 per kilowatt, including booster and switch-board arrangement, or an expenditure of £3,600.”

A 500-volt battery was under consideration, and by “as a maximum” the author in this case doubtless means the one-hour rate. It is seen from the note at the foot of Table LXIXA. that it is based on 30 per cent. less capacity than corresponds to the maker’s guarantees, hence we must for comparison take from Highfield’s data the

ELECTRIC RAILWAY ENGINEERING

cost of a $300 \times 0.70 = 210$ kilowatts battery. This is £18 per kilowatt, or $210 \times 18 = \text{£}3,800$, *i.e.*, 5.5 per cent. higher than the price quoted in Grindle's paper.

In the *Street Railway Journal* for July, 1901, is an article by Lamar Lyndon, entitled "The Storage Battery in Railway Power Station Service." In this paper a cost of £31,120 is given for a battery and booster equipment complete and installed. This is, on a three-hour discharge basis, a 6,150 ampere-hour, 550 volt installation, *i.e.*, 1,130 kilowatts for three-hour discharge. This would be equivalent to only $1,130 \times 0.70 = 800$ kilowatts, on Highfield's rating, and his data shows a cost of about £32 per kilowatt. Hence, cost = $800 \times 32 = \text{£}25,600$, or 75 per cent. of the cost which Lyndon gives.

In Germany, a Hagen battery, which the makers would guarantee for 2,000 ampere hours on a one-hour discharge basis, would, complete with booster, installed for 550 volts, cost £8,000. This has a one-hour capacity of 1,100 kilowatts, but on Highfield's basis of rating, only 770 kilowatts.

Highfield's data would show for this a cost of about £16.8 per kilowatt, or $770 \times 16.8 = \text{£}12,900$, a price 61 per cent. higher than the price in Germany.

Summary.

Cost in Germany	= 100
.. England	= 160
.. America	= 210

As to the weights of material in these three cases, and the relative guarantees received, we have not enough data to ascertain. The above figures, however, throw some light on the reasons why batteries are used most frequently in Germany, less frequently in England, and only very rarely in America. One can roughly take £30 per kilowatt for large buffer batteries, as manufactured in England, and on the basis of the manufacturer's ratings as here defined for a three-hours' discharge.

TABLE LXIXA.

Cost of Battery-Booster Sets, including the Battery and Booster and Switch Gear complete and ready for work, but excluding the Battery House—One-hour Discharge Rate.

500 Volts.—One-hour Discharge Rate.							
Kilowatts Output at 1-hour Discharge Rate.	Volts.	Amperes (1-hour Discharge Rate).	Capital Cost in Pounds.	Cost in Pounds per Kilowatt (Rated on the 1-hour Discharge Basis).	Permissible Amperes for Momentary Rate.	Permissible Amperes for 3-hours Discharge Rate.	Kilowatts Output at 3-hours Discharge Rate.
3,750	500	7,500	53,000	14.1	10,000	3,750	1,875
750	500	1,500	12,700	16.9	2,000	750	375
375	500	750	6,650	17.7	1,000	375	187.5
225	500	450	4,050	18.0	600	225	112.5
150	500	300	2,730	18.2	400	150	75.0
75	500	150	1,690	22.5	200	75	37.5

At a 6-hours discharge rate, the amperes rate is 60 per cent. of that for a 3-hours discharge rate.

The batteries consist of 240 to 250 cells, and the capacity is taken as 30 per cent. less than the full-rated capacity when the battery is new, so that at the end of a period, depending on the work and treatment of the battery, the actual capacity will be up to its rated value.

The gear is all designed to work at the one-hour rate—if designed for the three-hours rate, a reduction of about 10 per cent. would be made.

This data is a re-arrangement of that in Highfield's paper, "Storage Batteries Controlled by Reversible Boosters," of May 9th, 1901. See *Journal Institution of Electrical Engineers*, Vol. XXX., p. 1046.

THE SUB-STATIONS

TABLE LXIXb.

Cost of Battery-Booster Sets, including the Battery and Booster and Switch Gear complete and ready for work, but excluding the cost of the Battery House—Three-hours Discharge Rate.

500 Volts—Three-hours Discharge Rate.

Kilowatts Output at 3-hours Discharge Rate	Volts.	Amperes (3-hours Discharge Rate)	Capital Cost in Pounds.	Cost in Pounds per Kilowatt (Rated on the 3-hours Discharge Basis).	Permissible Amperes for Momentary Rate.	Permissible Amperes for 1-hour Discharge Rate.	Kilowatts Output at 1-hour Discharge Rate.
1,875	500	3,750	53,000	28.2	10,000	7,500	3,750
375	500	750	12,700	33.8	2,000	1,500	750
187.5	500	375	6,650	35.4	1,000	750	375
112.5	500	225	4,050	36.0	600	450	225
75.0	500	150	2,730	36.4	400	300	150
37.5	500	75	1,690	45.0	200	150	75

At a 6-hours discharge rate, the amperes rate is 60 per cent. of that for a 3-hours discharge rate.

The batteries consist of 240 to 250 cells, and the capacity is taken as 30 per cent. less than the full-rated capacity when the battery is new, so that at the end of a period, depending on the work and treatment of the battery, the actual capacity will be up to its rated value.

The gear is all designed to work at the one-hour rate— if designed for the three-hours rate, a reduction of about 10 per cent. would be made.

This data is a re-arrangement of that in Highfield's paper, "Storage Batteries Controlled by Reversible Boosters," of May 9th, 1901. See *Journal Institution of Electrical Engineers*, Vol. XXX., p. 1046.

DESIGN OF SUB-STATIONS.

The design and lay-out of a sub-station is controlled by the area and shape of the site available. The whole of the plant should, if possible, be arranged on one floor, thereby minimising the attendance charges. With a large sub-station, the cost of land may make it necessary to build it double-decked. The path of the energy through the sub-station should be as short and direct as possible from the high tension lines to the outgoing continuous current feeders. In consistence therewith, the arrangement of plant across the station should be in the following order:—

Entrance of high tension cables, high tension switchgear, transformers, rotary converting apparatus (motor-generators or rotaries), low tension continuous-current switchgear. An arrangement of apparatus following on these lines is desirable in the interests of a maximum of simplicity. If the area is limited, or constrained to an irregular shape, departure from the simplest form may become unavoidable. We give subsequently detailed descriptions of several representative sub-stations from which the general trend of design can be followed.

Arrangement of Switchgear.—The switchboard is located along one side or across one end of the station. For small sub-stations it is generally on the main floor with the converting apparatus, but with stations of large capacity, the switchgear is often arranged on a gallery. In the latter case the operator commands a view of the whole station, which may on occasions be of considerable advantage. It is standard practice to build the switchboard in three sections, consisting of a set of panels for the high tension switchgear, a set of machine panels, and a set of distributing feeder panels. Where the high tension switchgear is of the remote control type, which is becoming common practice for high voltages, the oil switches are mounted in brick chambers

ELECTRIC RAILWAY ENGINEERING

some distance away from the switchboard. The first section of the board consists, in this case, of a low tension control board to deal with the current operating the oil-break high tension switches. Examples of these are given in the subsequent references to particular sub-stations. The control board is provided with pilot lamps, to indicate which high tension switches are closed. By such arrangements all the apparatus is manipulated by low tension switches, the high tension gear being completely isolated.

The Starting of Rotary Converters.

The starting and synchronising of rotary converters may be accomplished in any one of several ways. The simplest, at first sight, is to throw the alternating current terminals of the rotary converter directly on the alternating current low tension circuit, or else to have the low tension transformer terminals normally connected to the rotary converter, and to throw the high tension transformer terminals directly on the high tension mains. But this, although often practicable, has several disadvantages. By this method the current rush at the moment of starting is generally greatly in excess of the full-load current input to the rotary converter, and as it lags in phase by a large angle, it causes a serious drop of line voltage, and affects the normal line conditions, to the serious detriment of other apparatus on the line. This large current gradually decreases as the rotary converter's speed increases. The action of the rotary converter, in starting, is analogous to that of an induction motor. The rotating magnetic field set up by the currents entering the armature winding, induces, but very ineffectively, secondary currents in the pole-faces, and the mutual action between these secondary currents and the rotating field imparts torque to the armature, which revolves, with constantly accelerating speed, up to synchronism. Then the circuit of the rotary converter field spools is closed and adjusted to bring the current into phase. But when the armature is first starting, the field spools are interlinked with an alternating magnetic flux, generated by the current in the armature windings, and in normally proportioned field spools, with several hundreds or thousands of turns per spool, a dangerously high secondary voltage is generated in these spools. Hence they must be insulated better than field spools ordinarily are, not only between layers, but between adjacent turns: and wire with double or triple cotton covering should be used. However, the most frequently occurring breakdown due to this cause, is from winding to frame, and hence extra insulation should be used between these parts.

The terminals of the different field spools should be connected up to a suitable switch, arranged so that the field winding may be conveniently broken up into several sections; otherwise, if 1,000 volts or so are induced in each spool, the strain on the insulation between the ends of these spools in series and frame, is severe.

At starting, this switch must always be open, and must not be closed until the armature has run up to synchronous speed, which is observed by the line current falling to a much smaller value. This special switch is then closed, and afterwards the main field switch, whereupon a still further decrease in the line current occurs, due to improved phase relations, and the process of synchronising is completed.

By means of a compensator, this heavy current on the line at starting, may be avoided. The connections for a three-phase rotary with compensator, are as shown in the diagram of Fig. 176.

At the instant of starting, the three collector rings are connected to the three lowest contacts, and thus receive but a small fraction of the line voltage. They, however, receive several times the line current; *i.e.*, if the taps into the compensator

ELECTRIC RAILWAY ENGINEERING

It is possible to start more quickly, the following times having been recorded:—

300 kilowatts	16 seconds.
1,000	40 ..
1,500	65 ..

This includes the time necessary to close the high tension switch on the transformer, the time of starting by means of air-break lever switches, and the time required for closing the field switches, the direct current circuit breakers, and the line switch.

Another method in use, is to have a small induction motor direct-coupled to the shaft of the rotary converter for the purpose of starting the latter with small line currents.

The starting motor has fewer poles than the rotary converter and a higher synchronous speed, the motor thus being able to bring the rotary converter up to the synchronous speed of the converter.

The main advantage of this method is the increased reliability, since each rotary has its own independent starting motor; the latter, however, is an extra expense. Another disadvantage is that, as the torque of the induction motor varies as the square of the applied voltage, a small drop in voltage will decrease the starting torque to such an extent that it may not be sufficient to start the set.

Where there are several rotary converters in a sub-station, a much better way is that described in a British patent specification, in which the station is provided with a small auxiliary set consisting of an induction motor direct-coupled to a continuous-current dynamo, the latter being only of sufficient capacity to run the rotary converters, one at a time, up to synchronous speed as continuous-current motors. When this speed is arrived at, and synchronism attained between the alternating current collector rings and the line, the switch between them is closed, and the rotary converter runs on from the alternating current supply.

In many cases, a continuous-current system derives its supply partly from continuous-current generators and partly from rotary converters. In such cases, the rotary converter is simply started up as a motor from the continuous-current line, and then synchronised.

This method is practicable if there is continuous current available at the sub-station switchboard. This will not be so if a sub-station is totally shut down, and in this case the previous method, employing an induction motor-generator auxiliary set is useful, the induction motor running on the alternating supply.

Synchronising Rotary Converters.

One has the choice of synchronising the rotary converter either by a switch between the collector rings and the low potential side of the step-down transformers, or of considering the step-down transformers and the rotary converter to constitute one system, transforming from low-voltage continuous current to high-voltage alternating current, and synchronising by a switch placed between the high tension terminals of the transformers and the high tension transmission line. This latter plan is, perhaps, generally the best, as for the former plan one requires a switch for rather heavy currents at a potential of often from 300 to 400 volts: and such a switch, to be safely opened, is of much more expensive construction than a high tension switch for the smaller current. Moreover, for six-phase rotaries, the low tension switch should preferably have six blades, as against three for the high tension switch.

THE SUB-STATIONS

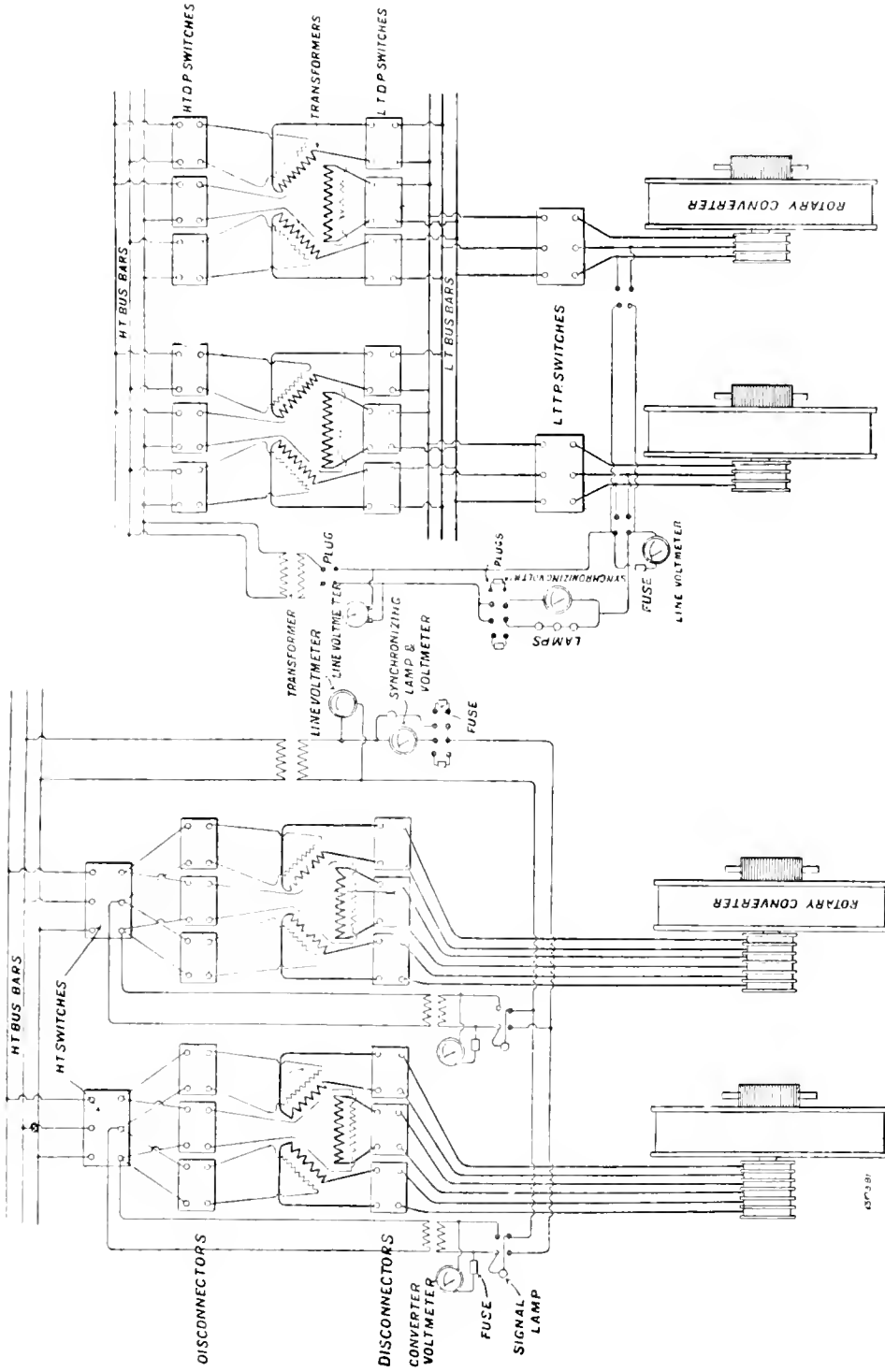

Fig. 178. Diagram of Connections Applicable to Three-Phase Rotaries.

Fig. 177. Diagram of Connections for Synchronizing and Switching Applicable to Six-Phase Rotary Converters.

ELECTRIC RAILWAY ENGINEERING

It is much simpler with six-phase rotary converters, to have an arrangement which obviates opening the connections between the low tension terminals of the transformers and the collector ring terminals, although in such cases some type of connectors should be provided which may be readily removed when the circuits are not alive, for purposes of testing.

The arrangement shown in Fig. 177 represents a plan for synchronising and switching on the high tension circuits, and adapted to six-phase rotaries.

Fig. 178 shows diagrammatically a plan for a three-phase system where the switching is done on the low tension circuits.

Starting of Asynchronous Motor Generator Sets.

Induction motor sets can be started, firstly, by switching the induction motor directly upon the high tension line and running up to speed by cutting out resistance in the motor circuit.

This is a simple arrangement, and there is only required a variable resistance, which can be mounted with its switch on a pillar near each set, thus avoiding long cables for the heavy rotor currents from the set to the switchboard. If the motors have permanently short-circuited squirrel cage rotors, they can be started by means of a compensator in the stator circuit, as already described in connection with the starting of rotary converters.

If any continuous-current is available at the sub-station, whether from a set already running, or from another sub-station, it is possible to start up a small auxiliary motor-generator set from the continuous-current side, running the generators as shunt motors.

If this method is adopted, the induction motors may all have squirrel cage rotors, and no compensators in the stator circuits. However, in order to provide for the event of failure in the continuous-current supply, it is advisable to instal at least one set with a slip-ring induction motor, or with a compensator, so that it can be started up from the high tension side.

DESCRIPTIONS OF TYPICAL SUB-STATIONS.

We shall now give technical data relating to the sub-stations on the following railways which are representative of modern practice:—

- (1) Central London Railway;
- (2) Metropolitan Railway;
- (3) Metropolitan District Railway;
- (4) North-Eastern Railway;
- (5) New York Central and Hudson River Railroad;
- (6) New York Subway of the Interborough Rapid Transit Co.

The data for all of these lines are presented collectively in tabular form in Tables LXX. to LXXII., from which many interesting conclusions may be drawn.

In addition to these data, there is given a short description of one sub-station on each line which is typical of sub-station practice on that line.

Table LXX. shows the total number of sub-stations on each line, the total number of converter sets, and their present and ultimate aggregate capacity.

Table LXXI. contains a complete list of the sub-stations on all these lines, with technical data for each station.

The table shows the distance between sub-stations and their distance from the generating stations, also the number and capacity of the transformers and converters, with the aggregate capacity of each station.

THE SUB-STATIONS

In Table LXXII. for a number of typical sub-stations on each line, there is given the capacity and floor area, from which is worked out the kilowatt capacity per square foot of floor area.

In the last column are entered remarks on the lay-out of the sub-station which would have a bearing on the values of the latter constant.

TABLE LXX.

Number of Sub-stations on various Electric Railways and their Capacity.

Railway.	Total Number of Sub-stations.	Number of Converters.		Total Capacity.	
		Installed.	Ultimate.	Installed.	Ultimate.
Central London Railway	4	8	8	7,200	7,200
Metropolitan Railway	8	22	28	18,800	24,000
District Railway	15	35	49	41,400	61,500
Great Northern, Piccadilly, and Brompton Railway ¹ .	9	19	28	17,600	26,000
Charing Cross, Euston, and Hampstead Railway					
Baker Street and Waterloo Railway					
North-Eastern Railway	5	14	20	11,200	16,000
New York Central and Hudson River Railroad	8	24	40	27,000	45,000
Interborough Rapid Transit (The Subway, New York)	8 (12 ult.)		98		147,000

¹ The sub-stations on these railways are supplied from the District Railway Generating Station at Lot's Road.

TABLE LXXI.

List of Sub-stations on various Electric Railways and Data regarding their Equipment.

Railway.	Substation.	Distance in Miles from Generating Station.		Number of Step-down Transformers.		Capacity of each Transformer.		Total Capacity of Transformers.		Number of Converters.		Capacity of each Converter.		Total Capacity of Converters.	
		Distance in Miles to next Further Substation along Route.	Instal- led.	Ulti- mate.	Instal- led.	Ulti- mate.	Instal- led.	Ulti- mate.	Instal- led.	Ulti- mate.	Instal- led.	Ulti- mate.			
Central London Railway.	Shepherd's Bush	—	1.61	4	4	300	1,200	1,200	1	1	900	900	900		
	Notting Hill Gate	1.61	1.82	7	7	300	2,100	2,100	2	2	900	1,800	1,800		
	Marble Arch	3.43	0.14	7	7	300	2,100	2,100	2	2	900	1,800	1,800		
	Davies Street	3.87	2.32	7	7	300	2,100	2,100	2	2	900	1,800	1,800		
	Post-office	6.20	—	7	7	300	2,100	2,100	2	2	900	1,800	1,800		
Metropolitan Railway.	Ruislip	7.75	4.25	6	9	300	1,800	2,700	2	3	800	1,600	2,400		
	Harrow	3.50	4.90	6	9	300	1,800	2,700	2	3	800	1,600	2,400		
	Neasden	—	3.50	6	9	300	1,800	2,700	3	3	800	2,400	2,400		
	Finchley Road	3.25	2.25	9	12	300	2,700	3,600	3	4	800	2,400	3,200		
	Gloucester Road	8.50	1.50	9	12	300	2,700	3,600	3	4	800	2,400	3,200		
	Bouyere Street	7.00	1.25	9	12	300	2,700	3,600	3	4	800	2,400	3,200		
	Baker Street	5.75	1.00	9	12	4.5	3,915	5,220	3	4	1,200	3,600	4,800		
	Euston Road	6.75	1.50	6	6	300	1,800	1,800	2	2	800	1,600	1,600		
Moorgate	8.25	—	6	6	300	1,800	1,800	2	2	800	1,600	1,600			

ELECTRIC RAILWAY ENGINEERING

TABLE LXXI.—*continued.*

Railway	Sub-station	Distance in Miles from Generating Station.	Distance in Miles to next Further Sub-station along Route.	Number of Stepdown Trans- formers.		Capacity of each Transformer.			Number of Converters.		Capacity of each Converter.			Total Capacity of Converters.	
				In- stalled.	Ulti- mate.	In- stalled.	Ulti- mate.	In- stalled.	Ulti- mate.	In- stalled.	Ulti- mate.	In- stalled.	Ulti- mate.		
														In- stalled.	Ulti- mate.
District Railway.	Sudbury	9.59	4.00	6	9	300	1,800	2,700	2	3	800	1,600	2,400		
	Hounslow	9.90	4.50	6	9	300	1,800	2,700	2	3	800	1,600	2,400		
	Kew Gardens	6.10	2.25	6	9	435	2,610	3,915	2	3	1,200	2,400	3,600		
	Mill Hill Park	5.45	2.25	9	12	435	3,915	5,220	3	4	1,200	3,600	4,800		
	Ravenscourt Park	3.27	1.75	6	9	550	3,300	4,950	2	3	1,500	3,000	4,500		
	Earl's Court	1.90	1.00	9	12	550	4,950	6,600	3	4	1,500	4,500	6,000		
	Wimbledon Park	5.83	2.50	6	9	435	2,610	3,915	2	3	1,200	2,400	3,600		
	Putney Bridge	3.29	1.75	6	9	300	1,800	2,700	2	3	800	1,600	2,400		
	South Kensington	2.31	1.50	6	9	550	3,300	4,950	2	3	1,500	3,000	4,500		
	Victoria	3.72	1.50	6	9	435	2,610	3,915	2	3	1,200	2,400	3,600		
	Charing Cross	5.07	1.25	12	12	550	6,600	6,600	4	4	1,500	6,000	6,000		
	Mansion House	0.37	1.87	6	9	550	3,300	4,950	2	3	1,500	3,000	4,500		
	Whitechapel	8.15	1.75	9	12	550	4,950	6,600	3	4	1,500	4,500	6,000		
	Canphell Road	10.35	3.50	6	9	435	2,610	3,915	2	3	1,200	2,400	3,600		
	East Ham	13.34	—	6	9	435	2,610	3,915	2	3	1,200	2,400	3,600		
Sub-stations fed from Let's Road Generating Station, supplying Great Northern, Piccadilly, Brompton, Charing Cross, Euston, and Hamp- stead Railways.	Golders Green	11.36	2.25	9	12	300	2,700	3,600	3	4	800	2,400	3,200		
	Belsize Park	9.15	2.25	6	9	435	2,610	3,915	2	3	1,200	2,400	3,600		
	Baker Street	7.57	1.90	6	9	300	1,800	2,700	2	3	800	1,600	2,400		
	Hyde Park Corner	3.34	2.00	6	9	300	1,800	2,700	2	3	800	1,600	2,400		
	Euston Station	6.62	1.90	6	9	300	1,800	2,700	2	3	800	1,600	2,400		
	Kentish Town	8.30	2.00	6	9	300	1,800	2,700	2	3	800	1,600	2,400		
	Russell Square	5.62	1.25	6	9	435	2,610	3,915	2	3	1,200	2,400	3,600		
	Holloway	7.83	2.50	6	9	435	2,610	3,915	2	3	1,200	2,400	3,600		
	London Road	6.42	—	6	9	300	1,800	2,700	2	3	800	1,600	2,400		
	North-Eastern.	Parsons Dene	4.00	4.00	12	12	280	3,360	3,360	4	4	800	3,200	3,200	
Cultercoats		5.75	5.75	9	12	280	2,520	3,360	3	4	800	2,400	3,200		
Wallsend		0.25	3.75	9	12	280	2,520	3,360	3	4	800	2,400	3,200		
Beaton		2.50	4.00	6	12	280	1,680	3,360	2	4	800	1,600	3,200		
Kenton		7.00	4.25	6	12	200	1,680	3,360	2	4	800	1,600	3,200		
New York Southern Section of New York Central and Hudson River Railroad.	1. Grand Central Terminal	0.36	—	9	15	550	4,950	8,250	3	5	1,500	4,500	7,500		
	2. Mott Haven	5.473 5.492	—	9	15	550	4,950	8,250	3	5	1,500	4,500	7,500		
	3. Kingsbridge	9.44	—	9	15	375	3,375	5,625	3	5	1,000	3,000	5,000		
	4. Yonkers	15.94	—	9	15	375	3,375	5,625	3	5	1,000	3,000	5,000		
	5. Irvington	22.41	—	9	15	375	3,375	5,625	3	5	1,000	3,000	5,000		
	6. Ossining	30.31	—	9	15	375	3,375	5,625	3	5	1,000	3,000	5,000		
	7. Bronx Park	9.30	—	9	15	375	3,375	5,625	3	5	1,000	3,000	5,000		
	8. Scarsdale	19.02	—	9	15	375	3,375	5,625	3	5	1,000	3,000	5,000		

1 Hudson Division.

2 Harlem Division.

THE SUB-STATIONS

TABLE LXXI.—*continued.*

Railway	Substation.	Distance in Miles from Generating Station.		Number of Stepdown Transformers.		Capacity of each Transformer.	Total Capacity of Transformers.		Number of Converters.		Capacity of each Converter.	Total Capacity of Converters.	
		Distance in Miles to West in their Substation along Route.	Distance in Miles to East in their Substation along Route.	Installed.	Ultimate.		Installed.	Ultimate.	Installed.	Ultimate.			
Interborough Rapid Transit (The Subway, New York)	No. 11, Worth Street	1.54	1.70	12	24	550	7,600	13,200	4	8	1,500	6,000	12,000
	No. 12, Union Square	2.78	2.18	—	24	550	—	13,200	—	8	1,500	—	12,000
	No. 13, 8th Avenue	0.66	2.08	—	30	550	—	16,500	—	10	1,500	—	15,000
	No. 14, 96th Street	2.18	2.27	18	24	550	9,900	13,200	6	8	1,500	9,000	12,000
	No. 15, 143rd Street	4.45	2.55	—	24	550	—	13,200	—	8	1,500	—	12,000
	No. 16, 132nd Street	4.35	2.08	—	24	550	—	13,200	—	8	1,500	—	12,000
	No. 17, H Island Avenue	7.05	2.55	—	24	550	—	13,200	—	8	1,500	—	12,000
	No. 18, Fox Street	7.46	3.02	—	24	550	—	13,200	—	8	1,500	—	12,000

TABLE LXXII.

Floor Space of various Electric Sub-stations.

Railway.	Substation	Ultimate Plant Capacity.	Floor Area in Square Feet.	Kilo-watts per Square Foot.	Remarks.
Central London Railway.	Notting Hill Gate	1,800	830	2.17	Sub-stations built in two circular shafts sunk in the ground.
	Marble Arch	1,800	830	2.17	
Metropolitan Railway.	Ruislip	2,400	2,790	0.86	Transformers on main floor.
	Harrow	2,400	2,790	0.86	„ „ „
	Finchley Road	3,200	3,660	0.875	„ „ „
District Railway.	Kew Gardens	3,600	2,110	1.68	Transformers on gallery.
	Mill Hill Park	4,800	2,760	1.74	„ „ „
	Wimbledon Park	3,600	2,110	1.68	„ „ „
	Putney Bridge	2,400	1,880	1.28	„ „ „
	Victoria	3,600	2,110	1.68	Transformers on main floor.
	Charing Cross	6,000	2,980	2.00	Transformers on gallery.
	Campbell Road	3,600	2,110	1.68	„ „ „
North-Eastern.	East Ham	3,600	2,110	1.68	„ „ „
	Pandon Dene	3,200	3,840	0.83	Transformers on main floor.

ELECTRIC RAILWAY ENGINEERING

TABLE LXXII.—*continued.*

Railway.	Sub-station.	Ultimate Plant Capacity.	Floor Area in Square Feet.	Kilo- watts per Square Foot.	Remarks.
New York Suburban Section of New York Central and Hudson River Railroad.	Grand Central Terminal	7,500	4,796	1.56	} Each sub-station has battery equipment.
	Mott Haven	7,500	3,845	1.95	
	Kingsbridge	5,000	3,845	1.30	
	Yonkers	5,000	3,639	1.37	
	Irvington	5,000	3,845	1.30	
	Ossining	5,000	3,845	1.30	
	Bronx Park	5,000	3,845	1.30	
	Searsdale	5,000	3,845	1.30	
Interborough Rapid Transit (The Subway, New York).	No. 14, 96th Street . .	12,000	5,000	2.4	} Transformers on main floor.
	No. 11, Worth Street . .	12,000	6,000	2.0	
	No. 16, 132nd Street . .	12,000	6,000	2.0	
	No. 12, Union Square . .	12,000	4,400	2.7	

1. *Sub-stations on the Central London Railway.*

The sub-stations, as originally laid down, were built underground in circular shafts. The Bond Street Sub-station, which was put down since the opening of the line as an emergency station and chiefly for supplying lifts and lighting, is the only one which is on the ground level. The other stations are situated in the base of the lift shafts, below the level of the platforms, and are therefore at a depth of 120 ft. and more below the street surface.

At Notting Hill Gate the whole of the equipment is contained in a single chamber 30 ft. diameter and 21 ft. high, but at Marble Arch and at Post-office, the plant is divided between two chambers each 23 ft. diameter and 15 ft. high.

Fig. 179 shows the general arrangement of the Marble Arch Sub-station, from which a good idea of the lay-out of the transformers, rotary converters, and switchboards, may be obtained.

The normal maximum output of each sub-station is 1,800 kilowatts, but this could be increased on occasion by 20 per cent. without any difficulty.¹

The plant in each case consists of seven transformers, two rotary converters, and the necessary switchboards, blowers, etc. A novel kind of radial overhead crane, consisting of girders pivoted to the centre of the roof, and supported by wheels running on a circular rail at the circumference, provides for the ready handling of the machinery at Notting Hill Gate; part of this is visible in the

¹ A large part of this description of the Central London Railway sub-stations is taken by permission from the *Electrical Review* for June 15th, 1900, pp. 1012-1018. It was prepared for the *Electrical Review* by Mr. A. H. Allen.



THE SUB-STATIONS

view of the main switchboard shown in Fig. 180. The two converters and the bank of transformers form three sides of a square, from the open side of which

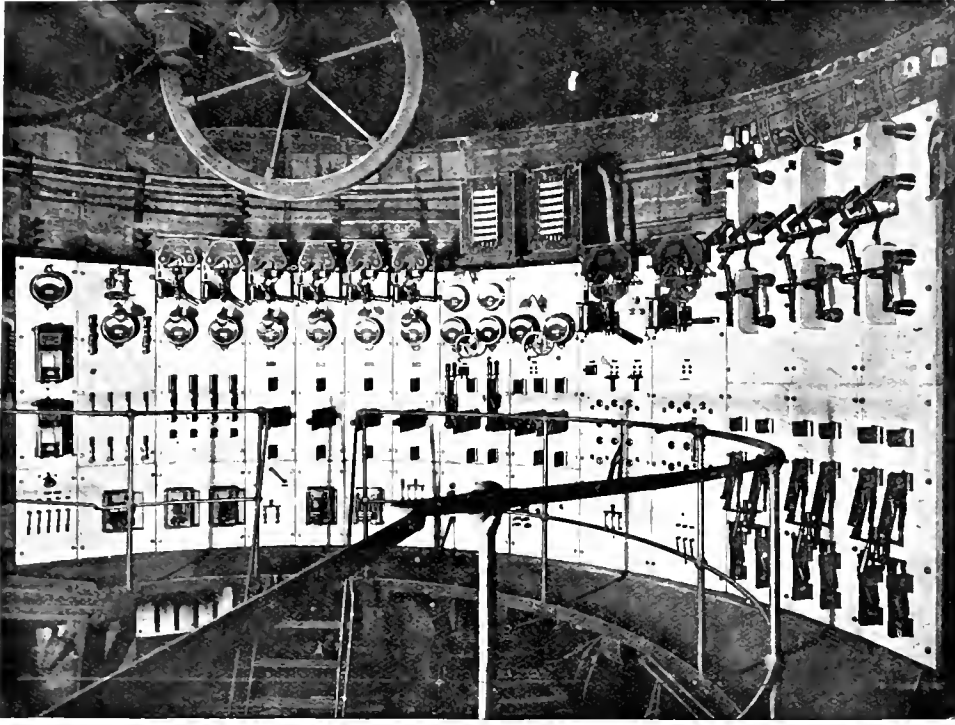

Fig. 180. CENTRAL LONDON RAILWAY: NOTTING HILL GATE SUB-STATION MAIN SWITCHBOARD.

a ladder leads to the switchboard gallery; this extends half-way round the room at a height of 6 ft. 5 ins. from the floor level.

In Fig. 181 is given a diagram showing the general arrangement of the connections of two of the sub-stations. From the connection boxes, one in each tunnel, two high tension feeder cables enter the room and pass through Parshall three-phase switches to the high tension bus bars which are mounted above the alternating current panels of the switchboard. An ammeter transformer is mounted on one of the bars to indicate the total current entering the sub-station; a view of this bus-bar transformer is given in

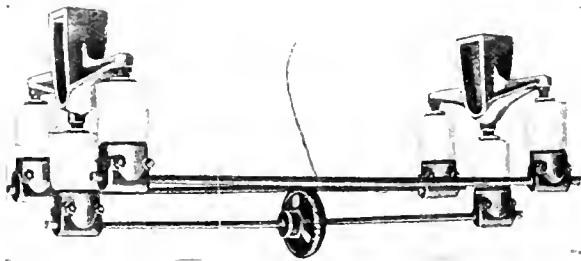
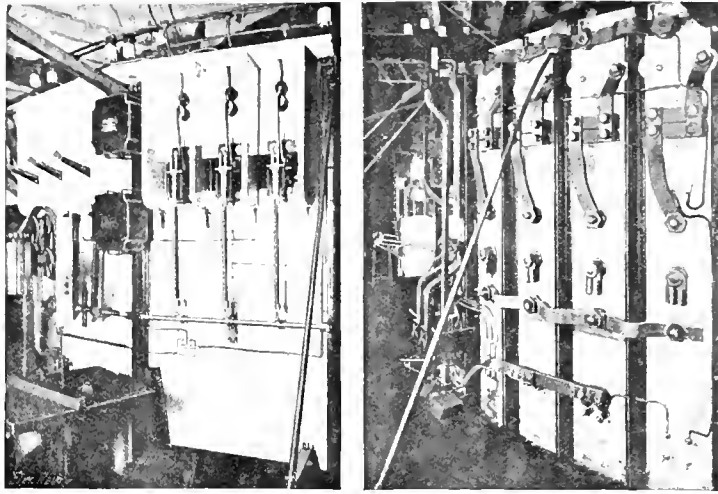

Fig. 182. CENTRAL LONDON RAILWAY: ARRANGEMENT OF HIGH TENSION BUS BARS AND AMMETER TRANSFORMER.

Fig. 182, which also shows the method of supporting the bars. Fig. 183 shows, at the left, the back of the high tension panels, with the Parshall switch-gear and volt meter transformers, as they appeared when erected at the maker's works.

ELECTRIC RAILWAY ENGINEERING

Passing over a space in front of the ventilating trunk, the high tension bus bars



High Tension Feeder Panel.

Low Tension Feeder Panel.

Fig. 183. CENTRAL LONDON RAILWAY: BACK VIEW OF SUB-STATION SWITCHBOARD.
HIGH TENSION AND LOW TENSION FEEDER PANELS.

bring the three-phase currents to three transformer panels shown at the left in Fig. 184. Each of these is fitted with double-pole switches for the primary and

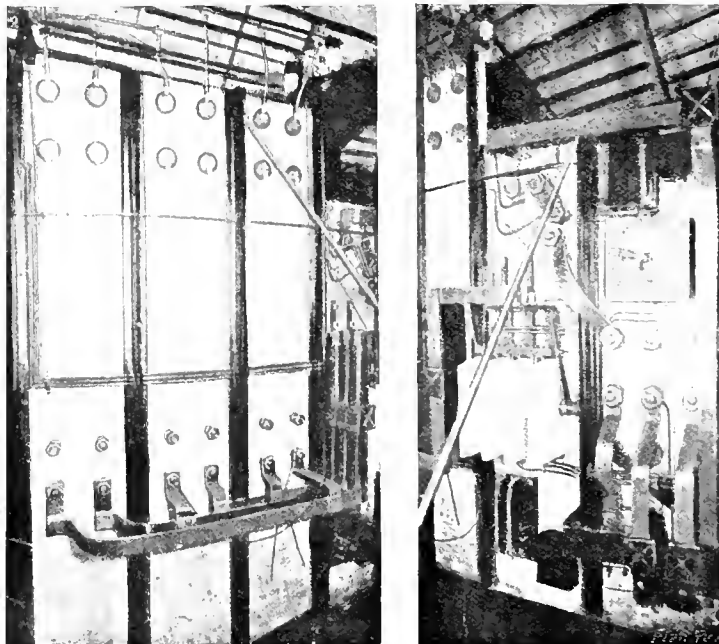

Transformer Panels.

Converter Panel.

Fig. 184. CENTRAL LONDON RAILWAY: BACK VIEW OF SUB-STATION SWITCHBOARD.
TRANSFORMER AND CONVERTER PANELS.

THE SUB-STATIONS

secondary circuits of two transformers. Each of the latter has a rated output of 300 kilowatts at a pressure of 330 volts on the secondary side when supplied at 5,000 volts, so that the normal secondary current is 910 amperes. The transformers are coupled up delta on both high and low tension sides. Fig. 185 shows

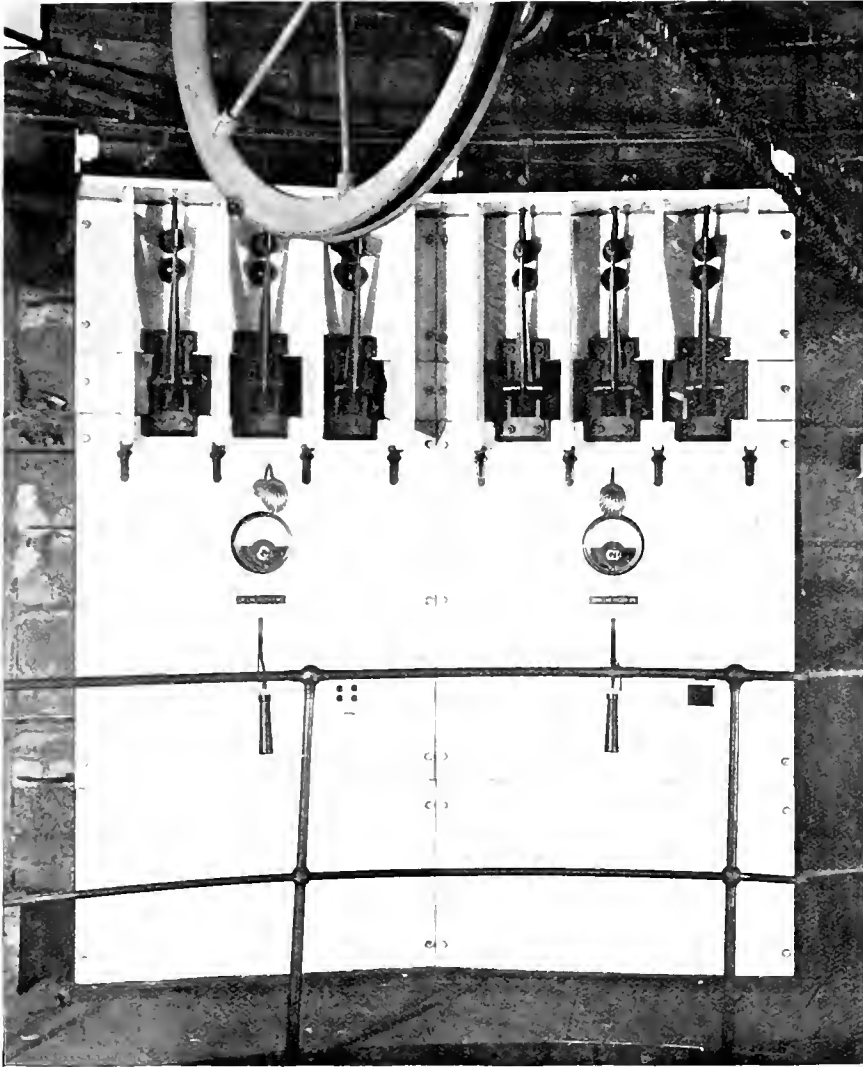

Fig. 184A. CENTRAL LONDON RAILWAY: FRONT VIEW OF HIGH TENSION PANELS, SHOWING THREE-PHASE SWITCH.

a view of the bank of transformers in place; and Fig. 186 gives part sectional drawings showing their internal construction. It will be seen that the coils are supported in a vertical position, with a horizontal core in the form of a double magnetic circuit.

The core is built up of steel laminae 0.014 in. thick, separately japanned, with

ELECTRIC RAILWAY ENGINEERING

ventilating ducts at frequent intervals. The steel is of special quality, having high permeability and low hysteresis losses, and alleged entire freedom, under the conditions of service, from deterioration due to ageing. The coils are wound on formers, in four primary and four secondary sections, arranged in series as shown in the plan. The transformers are cooled by an air blast, air being drawn through ducts between the coils and in the core; dampers are provided to regulate the draught by either path. There are two blowers driven by three-phase induction motors of 6 h.-p. each, with squirrel cage rotors; these exhaust the air from a trunk beneath the transformers, to which the case of each is connected. The blowers may be used either singly or together, but one is generally sufficient.

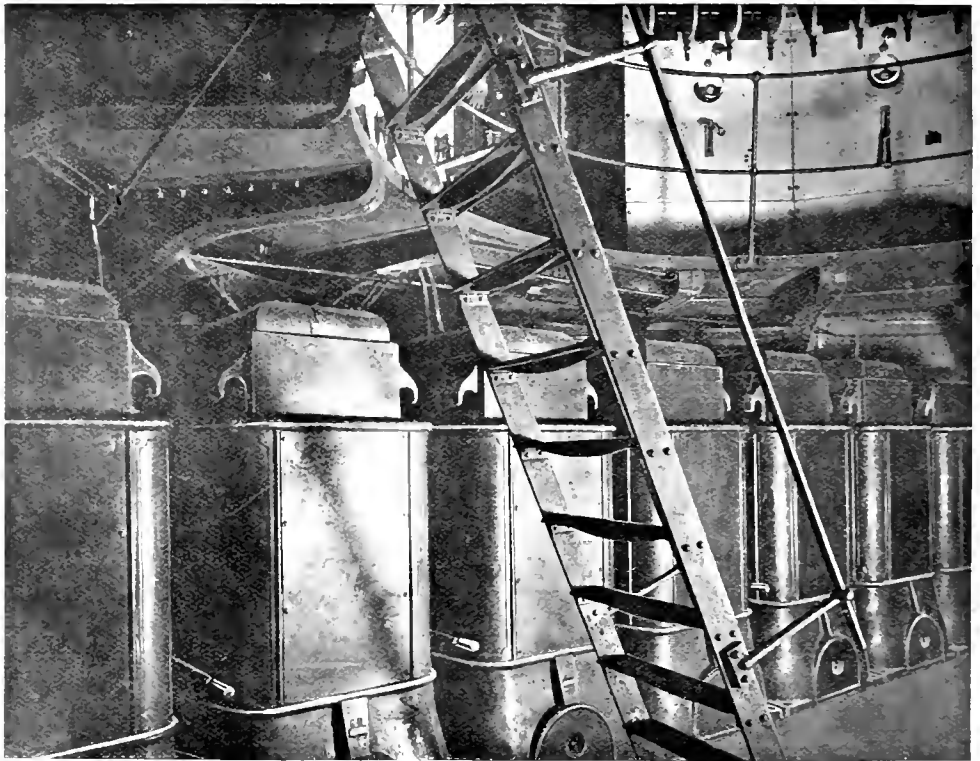

Fig. 185. CENTRAL LONDON RAILWAY: NOTTING HILL GATE SUB-STATION.
BANK OF 300-K.W. TRANSFORMERS.

The six transformers are so connected with the switchboard that any or all of them may be used, and a spare transformer is held in reserve to replace any that may require inspection or repair. As will be seen from the curves of Fig. 187, the efficiency is high and well sustained, being 95 per cent. at quarter-load and over 98 per cent. at full load. The analysis of the various losses is given with the efficiency curve.

From the secondary switches of the transformers, three heavy 'bus bars carry the current to the converter panels, a back view of one of which is given at the extreme right of Fig. 184. Each of these is fitted with two Samuelson three-phase quick-break switches, connected at the top with the 'bus bars, and at the bottom with

THE SUB-STATIONS

the leads to the alternating current side of the rotary converters. As these switches have to break 2,000 amperes at 330 volts on each blade, they are of very massive construction, and the phases are separated from one another by slabs of marble to prevent arcing. Fig. 188 shows one of these switches.

Following the course of the current, we now come to the rotary converters. These machines are rated at 900 kilowatts output, 1,800 amperes at 500 volts. Their overall dimensions are 11 ft. 8 ins. by 9 ft. 10 ins. by 9 ft. 9½ ins. high. They are twelve-polar, and being fed with three-phase currents at 25 periods per second, they run at 250 revolutions per minute. The normal potential difference between the collector rings is 330 volts.

In Fig. 189 we give a plan and sectional elevations showing their construction. The base is formed of a single iron casting supporting the bearings, magnet frame, and collector gear; the frame is of mild cast steel, to which the laminated steel magnet cores are bolted. The coils are wound on sheet iron spools with brass flanges; the shunt coil, of No. 11 B. and S., 912 turns per

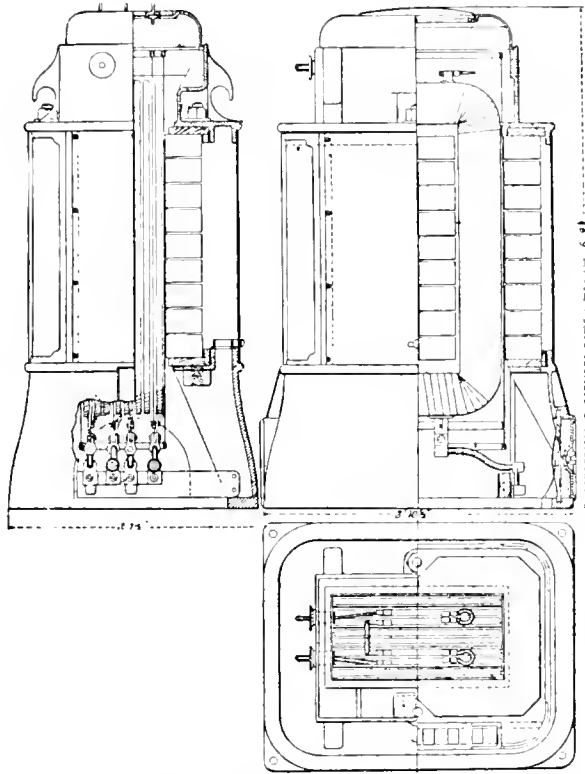

Fig. 186. CENTRAL LONDON RAILWAY: NOTTING HILL GATE SUB-STATION. 300-K.W. TRANSFORMER, ELEVATIONS AND PLAN.

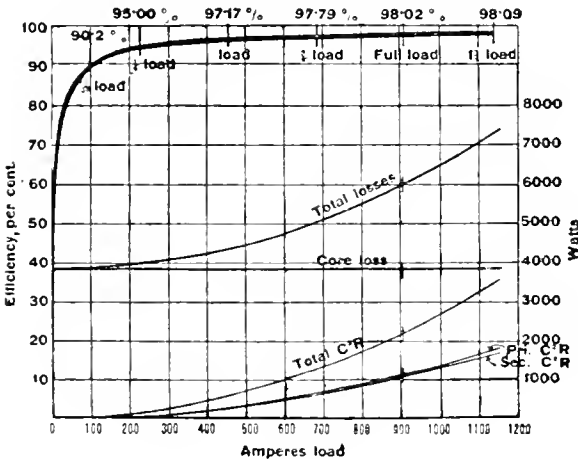

Fig. 187. 300-K.W. CENTRAL LONDON RAILWAY TRANSFORMER, EFFICIENCY AND LOSSES.

spool, is wound next to the yoke, and the series coil, of eight copper strips 2.5 in. by 0.075 in. in parallel, 2½ turns per spool, is close to the pole-pieces. The effect of compounding on a rotary converter is very interesting. Nominally the ratio of conversion from alternating to continuous current is invariable; but by causing the alternating current to lead or lag over the impressed E.M.F. it is possible to vary the effective pressure between the collector rings, so as to raise or lower the voltage on the commutator. For this purpose the armatures of the generators and rotaries, and the windings of the

ELECTRIC RAILWAY ENGINEERING

static transformers, possess sufficient reactance, and the series winding on the rotary has the effect of over-exciting the fields, causing the current to lead in phase, so that as the load increases the continuous current voltage rises correspondingly. By suitably shunting the series winding, the compounding of the rotaries may be adjusted to give quite constant pressure under the widest variations of load. This subject has been dealt with at considerable length on pp. 175 to 186 of this chapter.

The magnet cores are 12 ins. square overall, with a polar arc of $15\frac{1}{2}$ ins. on an internal diameter of 84.375 ins.; the induction density in the cores is 95,000 lines per square inch, while in the yoke, which is 22 ins. wide, the density is 48,000.

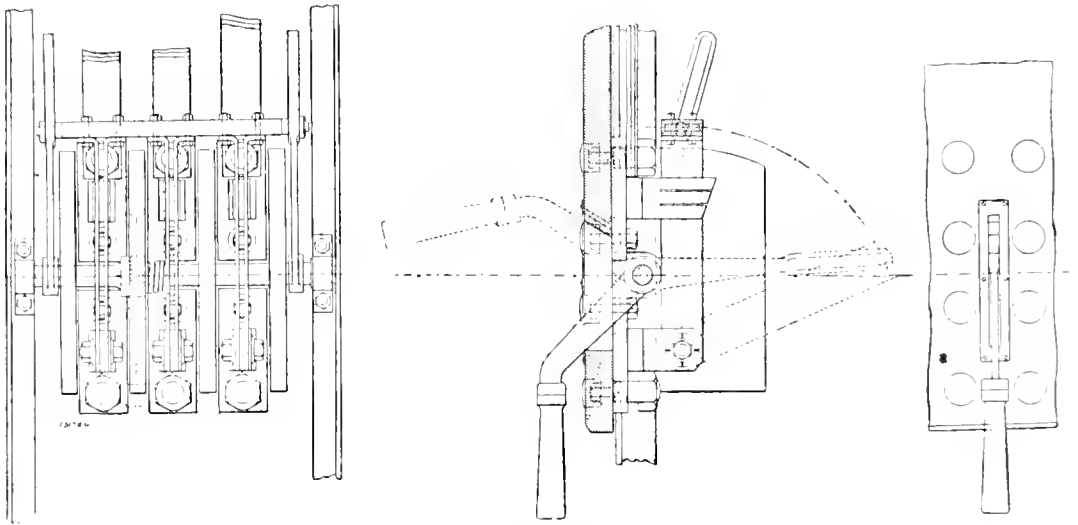

Fig. 188. CENTRAL LONDON RAILWAY: SAMUELSON'S TRIPLE POLE QUICK BREAK SWITCH FOR ROTARY CONVERTER.

The magnet frame can be bodily slid along the bed-plate so as to completely expose the armature and field-magnet windings.

The armature is built up of insulated sheet steel laminae 0.014 in. thick, secured by dovetailing to a heavy cast-iron spider.

The overall diameter of the armature is 7 ft., and the inside diameter of the core 5 ft. 2 ins.; the gross length of the core is 12.5 ins. There are 288 slots, each 1.25 ins. deep \times 0.44 in. wide; the induction density in the teeth is 128,000 lines per square inch, and in the core itself 51,000 lines.

The armature is of the drum type, multiple-wound with bar conductors: there are four of these in each slot, measuring 0.4×0.125 in. each.

The three collector rings are joined with the armature winding at eighteen equidistant points; the rings are 24 ins. diameter by $3\frac{1}{2}$ ins. wide, mounted on a separate spider, and there are eight copper brushes to each ring.

The commutator is 54 ins. diameter by $17\frac{1}{2}$ ins. long, and consists of 576 segments, carried on a cast-iron spider. There are twelve sets of carbon brushes, eight blocks, $1\frac{1}{4}$ ins. wide by $\frac{3}{4}$ in. thick, forming a set. These are carried by a cast-iron ring supported

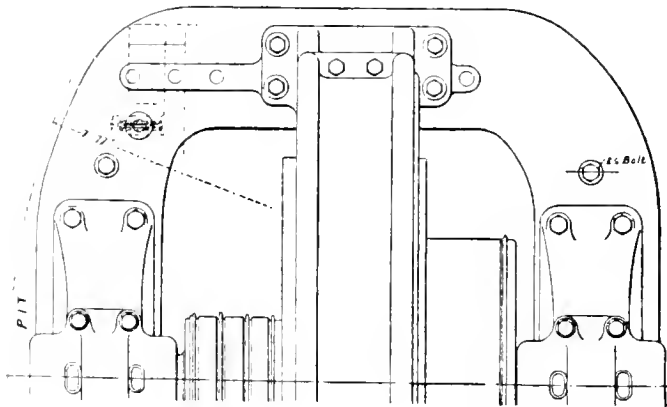
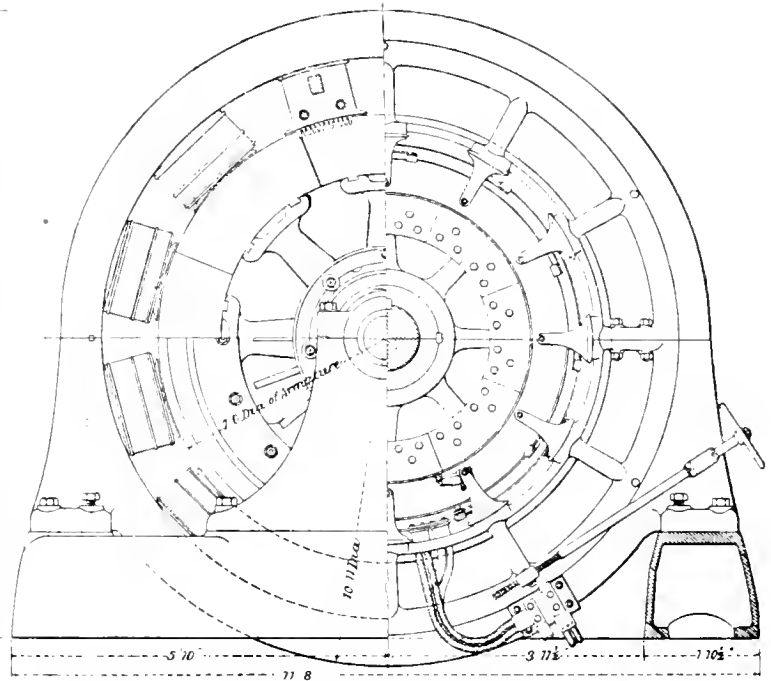
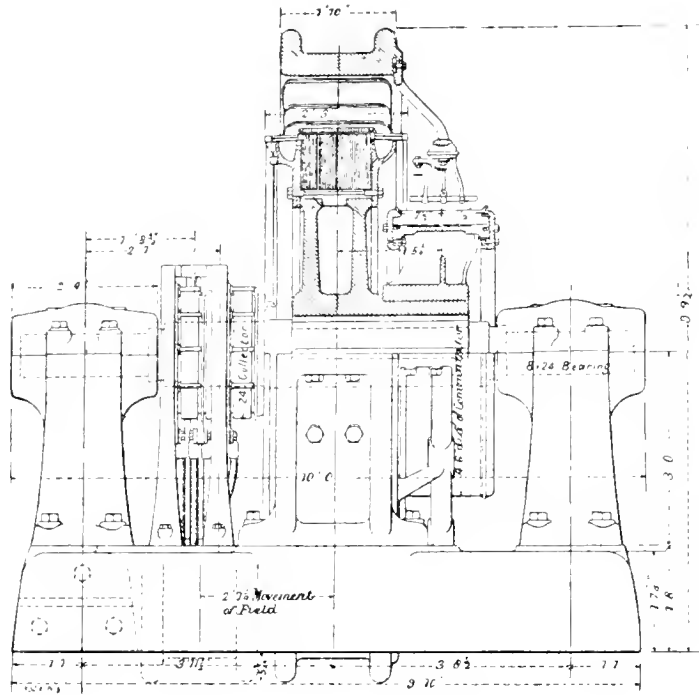

Fig. 189. CENTRAL LONDON RAILWAY. 900-K.W. ROTARY CONVERTER.

THE SUB-STATIONS

by brackets from the yoke, and can be adjusted simultaneously by a handwheel and

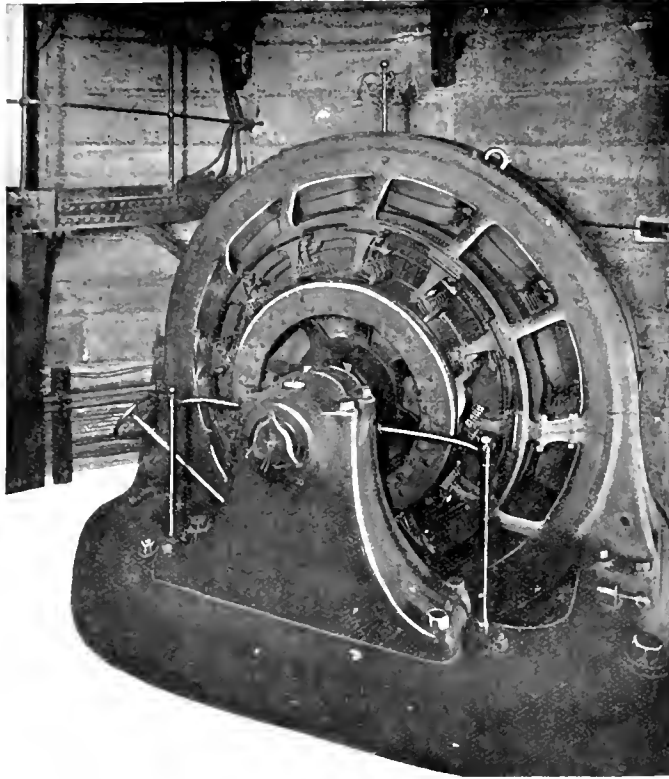

Fig. 190. CENTRAL LONDON RAILWAY: 900-K.W. ROTARY CONVERTER.

worm, though, in actual working, the brushes remain at the mechanically neutral point, whatever the load.

The armature core weighs 7,000 lbs., and the copper 721 lbs.; the total weight is 24,800 lbs. The magnet frame weighs complete 19,550 lbs., and the whole machine 48,350 lbs. Fig. 190 is a photograph of one of these 900 kilowatts rotary converters.

The curves of efficiency and losses of these machines are shown in Fig. 191. The overall efficiency, it will be seen, is 95 per cent. at full and overload, and 92½ per cent. at half-load: it is not probable that the average load will fall below the latter value.

The magnetisation curve (Fig. 192), which is given in terms of

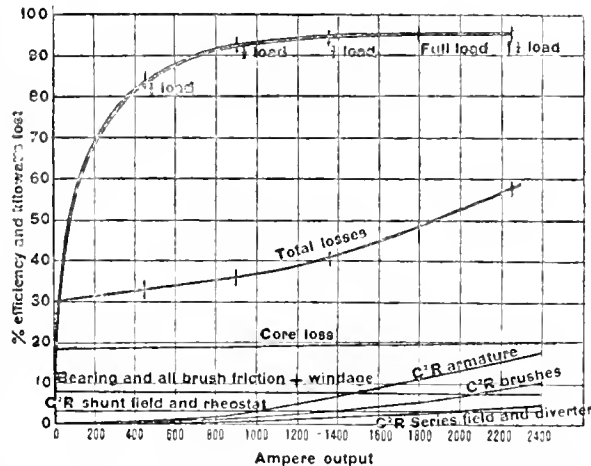

Fig. 191. CENTRAL LONDON RAILWAY: CURVES OF EFFICIENCY AND LOSSES OF 900-K.W. ROTARY CONVERTER.

ELECTRIC RAILWAY ENGINEERING

both alternating and continuous-current voltage, shows the relation between these to be about 0.6 to 1 at practically all values of the magnetisation. The "phase characteristic" (Fig. 193) shows the great importance of accurately ascertaining the most suitable value of the field excitation, so as to obtain the best possible power factor.

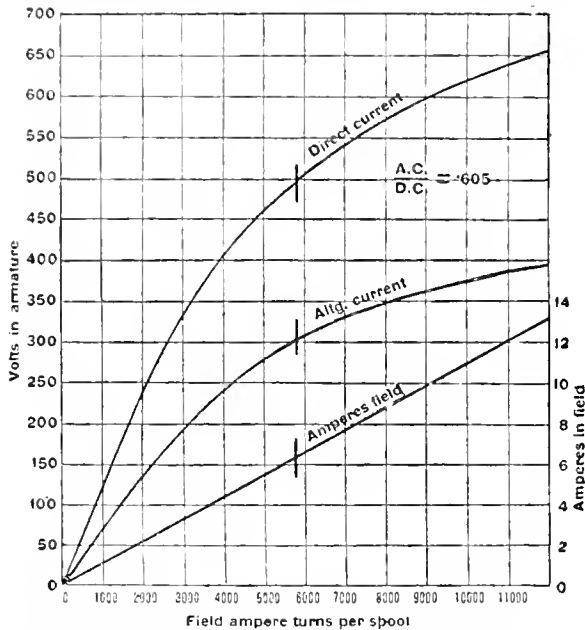

Fig. 192. CENTRAL LONDON RAILWAY: MAGNETISATION CURVE OF 900-K.W. ROTARY CONVERTER.

the purpose of avoiding the induction of an excessive E.M.F. in these coils. The high tension feeder switch and the three-phase rotary switch are then closed in succession, and the rotary starts up with about 2,000 amperes per collector ring. Full speed is reached in some 30 seconds. When synchronism is practically attained, the field circuit is closed, care being taken to do this when the continuous current E.M.F. is building up in the right direction, as shown by the volt meter. If, however, the polarity is wrong, a fresh start may be made, or the second rotary run up; if this also has the wrong polarity, one may be reversed from the other by means of the reversing field switch. Another method is to close all the necessary

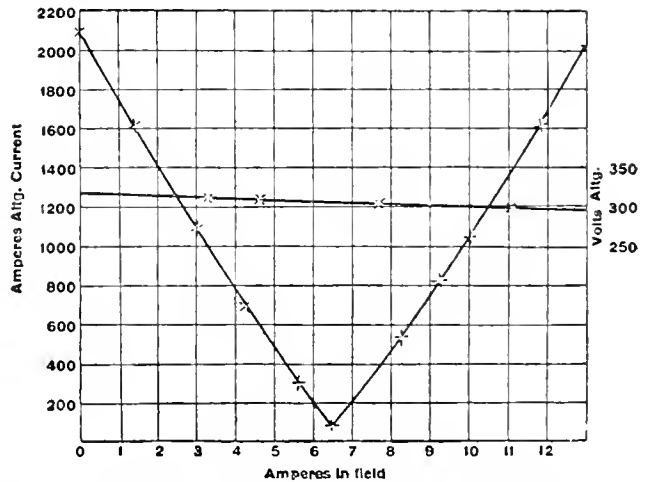

Fig. 193. CENTRAL LONDON RAILWAY: PHASE CHARACTERISTIC OF 900-K.W. ROTARY CONVERTER.

switches before the engine starts, and run up slowly. When one rotary is running, the others can be started as continuous-current motors from the line. For this purpose, the equaliser switch is thrown down, and the circuit breaker and field switch

THE SUB-STATIONS

closed; this excites the field of the incoming machine. The negative switch is then thrown downwards, and the starting rheostat closed step by step. The speed is then adjusted to synchronism, and the three-phase rotary switch closed, after which the continuous-current switches are opened, leaving the converter running as a synchronous motor. The continuous-current side is then paralleled with the line in the usual way.

Again following the current back to the switchboard, we arrive at the continuous current apparatus. There are two panels, one for each rotary, on which are mounted the positive, equaliser, and negative switches. By throwing up the equaliser switch, the positive brush ring is coupled direct to the positive 'bus bar, the converter then running as a shunt machine; when it is thrown down, the brush ring is connected with the equaliser bar for compound parallel running. When the negative switch is thrown upwards the machine is coupled with the negative 'bus bar through the circuit breaker, which is mounted above the corresponding three-phase switch; the downward position couples the negative terminal with the negative 'bus bar through the starting rheostat. A Weston ammeter is fixed on each panel, as well as a double-pole reversing field switch and reversible field ammeter, and rheostat hand-wheel.

A single, four-point, starting rheostat is mounted on one of the panels, coupled between the lower terminals of the negative main switches and the negative 'bus bar. An alternating current volt meter is provided which can be connected with the collector rings of either machine, as well as a synchronising volt meter and lamps.

The four feeder panels are fitted with circuit breakers and double-throw quick-break switches, as well as a Weston ammeter to each feeder. The third rail in each tunnel is cut by a section insulator near each sub-station, and the four ends are connected by feeders with the middle points of the feeder switches. These are arranged in pairs, two for the "up" tunnel and two for the "down." The lower contacts of each pair are coupled together by a short bar, so that when both switches are down, the third rail is electrically continuous and independent of the sub-station, and can be fed right through by the other sub-stations. In the upward position, the switches couple the positive 'bus with the third rail direct.

The negative 'bus bar is permanently connected with the track rails, and the total energy supplied to each tunnel is separately recorded by two Thomson watt-hour meters.

On the base of the feeder panels are mounted two three-phase switches controlling the blower motors, and a double-pole switch and starting rheostat for a series-wound Blackman fan motor, by means of which the sub-station is ventilated.

The next panel carries the apparatus for controlling the lift cables; there are two of these running the whole length of the line, one in each tunnel. These are arranged on the same plan as the third rails in that by throwing down the switches the cables are coupled through and are independent of the station; while by throwing them upwards they are connected with the positive 'bus bar. The current to the two "up" cables is passed through an ammeter and a watt-hour meter, and through one circuit-breaker; the same holds good for the "down" cables. The ammeter reads both sides of zero, so as to show the current restored to the line by the lift motors acting as regenerative brakes during the descent of the lifts.

The lighting feeders are entirely separate from the power circuits; a positive and a negative feeder for this purpose, run the whole length of each tunnel, and the distributing boards in each station are coupled with these on the three-wire system. The lighting feeders are connected with the + and - 'bus bars in each sub-station, and

ELECTRIC RAILWAY ENGINEERING

with several storage batteries at different points on the line. The lighting panel, next to the lift panels, is fitted with a minimum current cut-out to prevent the batteries from feeding back into the machine; when this comes out, the lighting load is thrown entirely on the batteries, which also carry the load when the line is shut down. There is a positive main switch on this panel by means of which the positive lighting 'bus bar is coupled to the positive main 'bus bar, while the negative main switch is double-throw, to connect the negative lighting 'bus bar direct with the

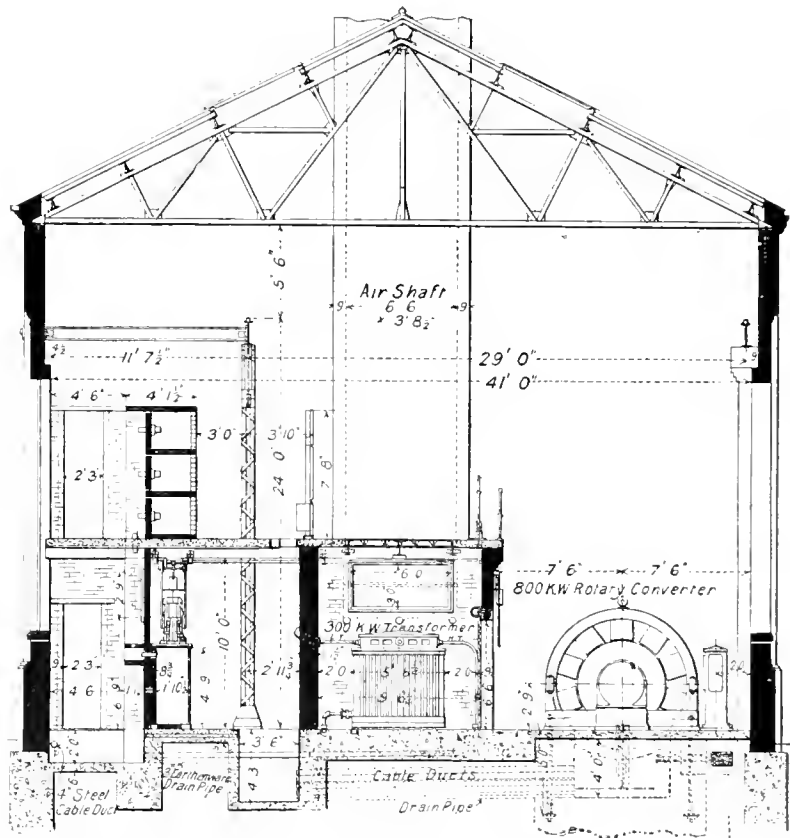

"THE ENGINEER"

Fig. 194. METROPOLITAN RAILWAY: RUISLIP AND HARROW SUB-STATIONS.

negative of either rotary, so that the lighting is unaffected by the circuit breaker. A main ammeter and a watt-hour meter are also provided for the lighting circuits.

The remaining panel of the switchboard is fitted with various instruments by Weston and Elliott Brothers for testing the leakage from the third rail, the drop in the track rails, and the total return by earth to the sub-station.

Fig. 180 shows the whole of the switchboard at Notting Hill Gate, except the high tension feeder panels. Figs. 183 and 184 show the backs of similar boards, and Fig. 184A shows the front of the high tension panels.

The number of safeguards against breakdown, provided by the arrangement described, is worthy of note; the sub-station can be supplied with power by either

THE SUB-STATIONS

or both feeders from the power station; the transformers and converters are in duplicate, and can be worked in various combinations; the connections with the line and the lift cables are also arranged so as to give the maximum number of alternatives, and the storage batteries ensure that, whatever might happen to the line, the lighting would be unaffected.

2. Sub-stations of the Metropolitan Railway.

Drawings of a typical sub-station are shown in Figs. 194 and 195, which relate to the Ruislip and Harrow stations. The arrangement of the sub-station will be readily

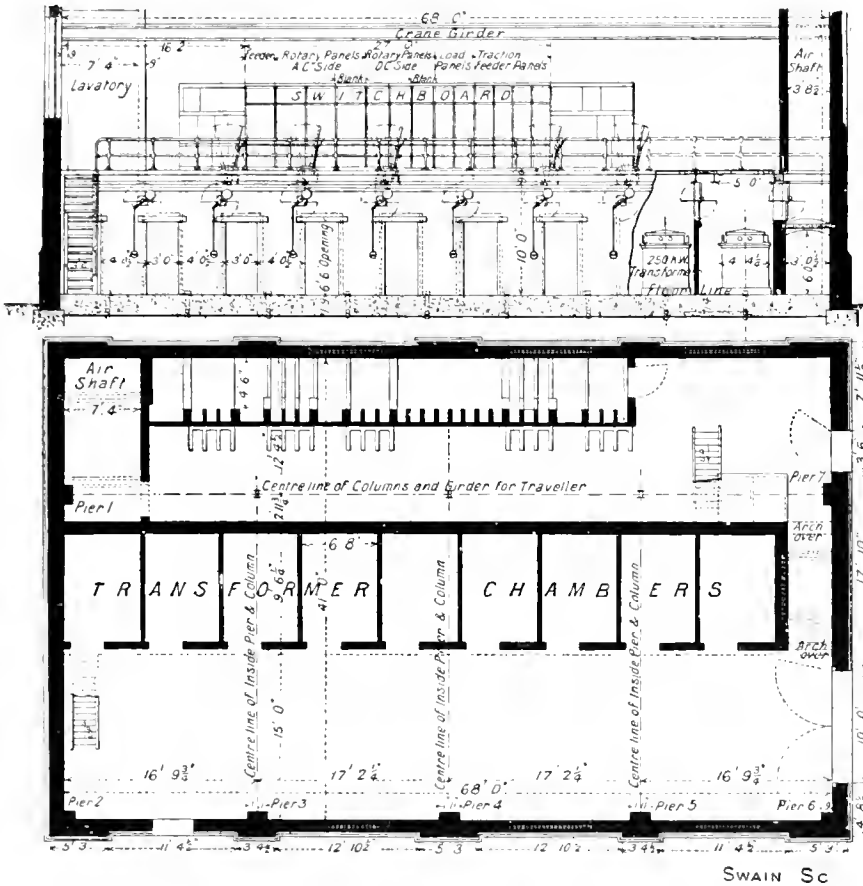

Fig. 195. METROPOLITAN RAILWAY: RUISLIP AND HARROW SUB-STATIONS.

understood. It will be seen that the transformers are in separate brick chambers, located underneath the switchboard gallery. An overhead traveller, carried on one side by steel pillars and on the other by stones projecting from the wall, serves to handle the transformers and rotary converters. Current is delivered from the mains at 11,000 volts, which is stepped down to 440 volts, at which it supplies the rotary converters, which deliver continuous current at 500 to 600 volts.

The transformer efficiency is 97 per cent. at half-load, and 97.4 per cent. at three-quarter load and full load. The temperature rise after 24 hours run on full load, is not

ELECTRIC RAILWAY ENGINEERING

more than 45 degrees Cent., and at 25 per cent. overload not more than 60 degrees Cent. With a 50 per cent. overload for 1 hour, the rise is not to exceed 60 degrees Cent. The transformers are oil-insulated, self-cooling. The regulation is within 1.75 per cent. between no load and full load. Each sub-station is equipped with a high tension switchboard provided with oil break switches, guaranteed to break the full voltage at any load which may possibly come on the plant, these being for controlling the various high tension feeder circuits and the static transformers supplying the rotary converters. The instruments are all of low voltage, and are connected to the various cables through transformers. The low tension switchboards have marble panels carried in iron frames. The high tension switches are controlled by means of signal levers, actuated from the switchboard platform, and the high tension switchboard

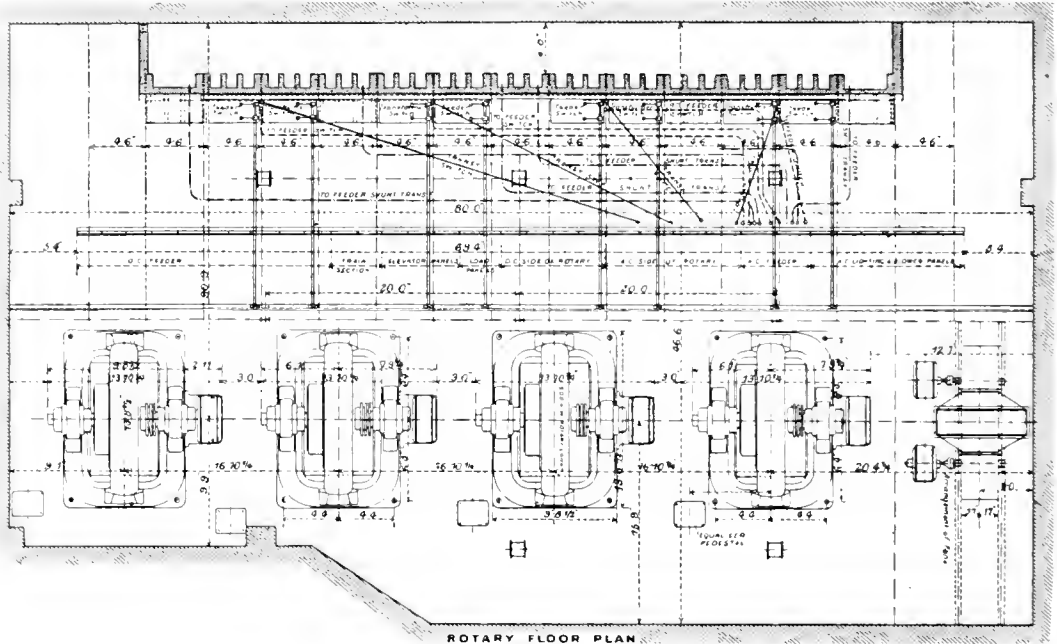

Fig. 196. DISTRICT RAILWAY: PLAN OF CHARING CROSS SUB-STATION.

settings are built of special bricks, $8\frac{3}{4}$ ins. by $4\frac{1}{4}$ ins. by $2\frac{3}{4}$ ins., laid with $\frac{1}{4}$ -in. cement joints, the cement mortar being made in the proportion of one of cement to two of sand.

The rotary converters which are situated on the main floor with the transformers, have ten poles of laminated steel. Their efficiencies are—

At half-load	$91\frac{1}{2}$ per cent.
At three-quarter load	94 ..
At full load	95 ..

The machines are specified to be over-compounded for 10 per cent. increase in voltage between no load and full load.

The temperature rise is specified not to exceed 40 degrees Cent. after 24 hours run on full load; with 25 per cent. overload, not greater than 50 degrees Cent., and with 50 per cent. overload for 1 hour, not greater than 60 degrees Cent.

THE SUB-STATIONS

The average voltage between segments is 11 volts, and carbon brushes are used. The guarantee as to sparking is that up to an overload of 50 per cent. no brush shift shall be required, and that with a temporary overload of 75 per cent. there shall be no serious sparking.

3. *Sub-stations of the District Railway.*

The sub-stations are arranged as shown in Figs. 196 and 197, which relate to the Charing Cross Station. The sub-stations are, with a few exceptions, built on land adjoining the railway, but at the Mansion House and at Victoria they are erected immediately above the railway tracks, and are supported on heavy girders. In these two stations, the general arrangement of Figs. 196 and 197 could not be adhered to, since, owing to "ancient light" claims of adjacent buildings, sufficient head-room could not be obtained. As may be seen from the figures, the main floor is occupied by the rotary converter sets and low tension switchboard. The transformers and high tension bus bars and switch-gear are erected on a gallery occupying the length of one

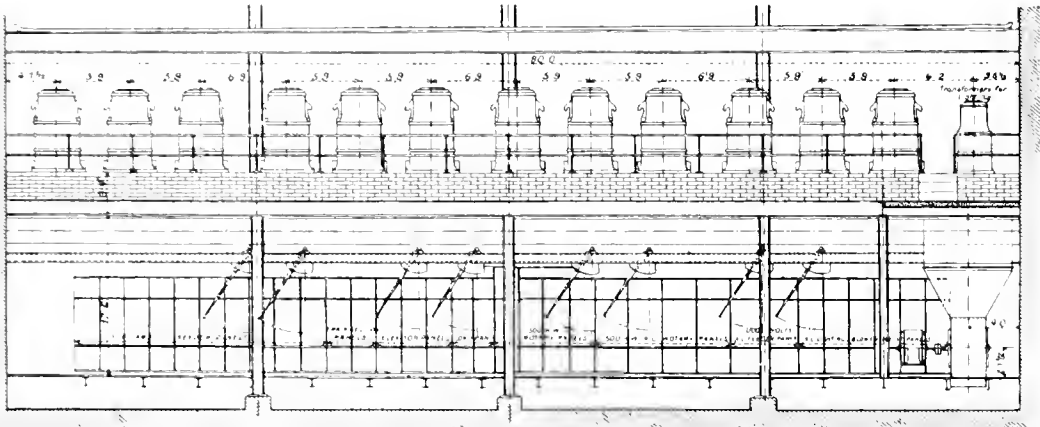

Fig. 197. DISTRICT RAILWAY: GALLERY ELEVATION CHARING CROSS SUB-STATION.

side of the station. This gallery had to be dispensed with at Mansion House and at Victoria, and at these two stations the transformers are located on the floor with the rotaries.

The Charing Cross Station is the largest and most important of the sub-stations. Besides its own section of the District Railway, this sub-station will feed portions of the Baker Street and Waterloo and of the Charing Cross and Hampstead lines.

The high tension feeders, four in number, enter at one side and are carried to a "high tension wall," on which are mounted the high tension isolating switches. The energy passes thence to the step-down transformers on a gallery immediately in front.

The switchboard is directly under the transformer gallery and on the main floor, with the rotary converters. The ends of the floor space are occupied by an air compressor, a motor generator, and blowers supplying the air blast for cooling the transformers. Below the ground floor is a basement for cables.

Fig. 198 shows a diagram of the connections at Charing Cross Sub-station, and Fig. 199 is a photo of a typical sub-station switchboard employed on this line.

The feeders on entering the sub-station are connected to isolating switches and

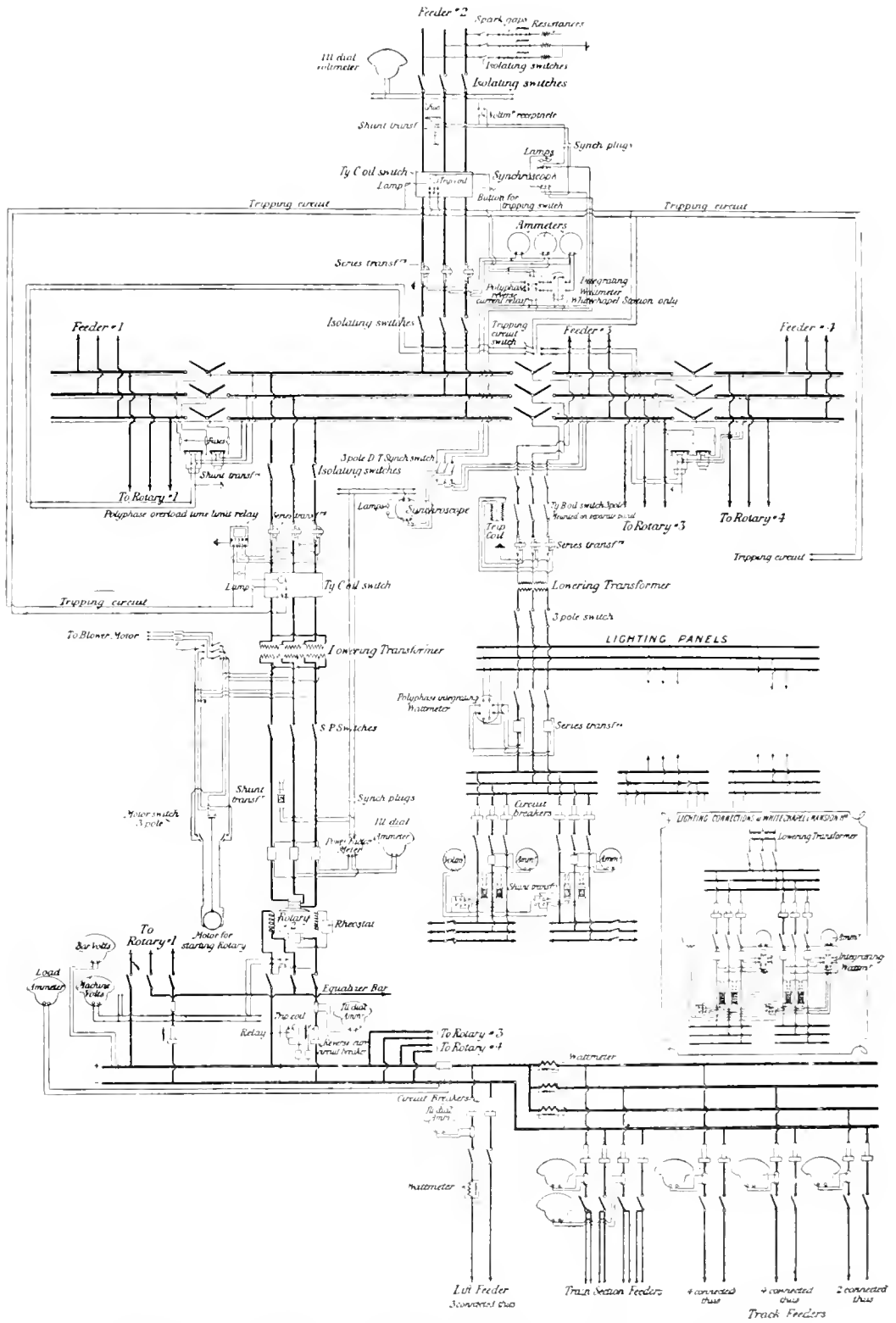

Fig. 198. DISTRICT RAILWAY: DIAGRAM OF CONNECTIONS AT CHARING CROSS SUB-STATION.

THE SUBSTATIONS

spark-gap lightning protectors. Reverse current relays are provided at the sub-station end of the high tension cables. Besides the usual instruments connected to the feeders, there is also a synchroscope, for indicating the phase before switching the feeder through. The main high tension bus bars are divided into four sections, with one feeder and one rotary converter connected to each. These bus-bar sections, by means of selector switches, may be operated independently or in multiple, as the case may require. Isolating switches are also fitted to each rotary converter circuit, thus providing a flexible arrangement of connection.

The secondary windings of the transformers are connected through three single pole knife switches to the collector rings on the rotary converter. The main high tension triple-pole oil switch for controlling each rotary, is hand-operated, but is also

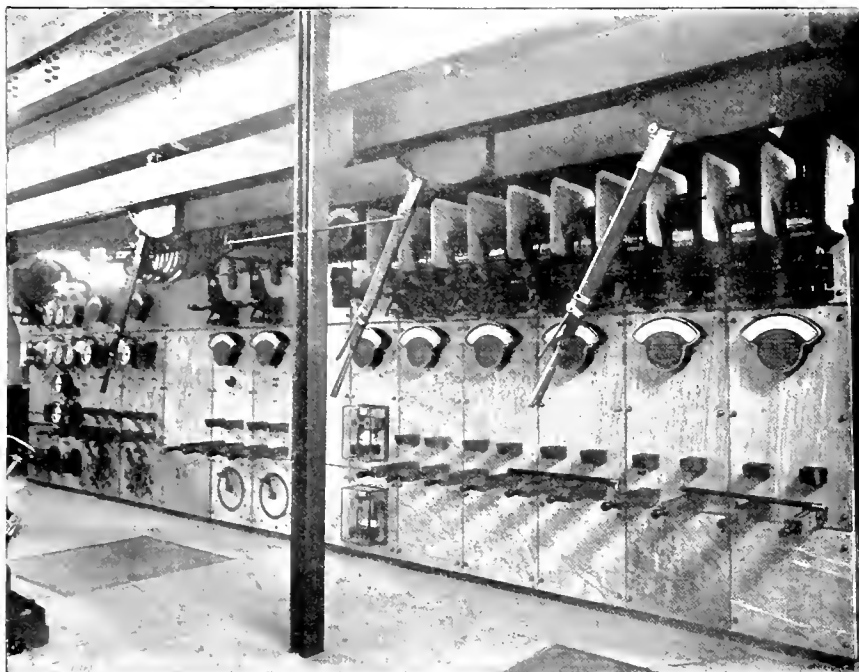

Fig. 199. DISTRICT RAILWAY: PUTNEY BRIDGE SUB-STATION SWITCHBOARD.

equipped with a polyphase overload time-limit relay. The continuous current side of the rotary is provided with two knife switches. A reverse-current circuit breaker is also inserted in the negative main. Each rotary converter is connected to an equaliser switch. The rotary converter is started by a small induction motor, and is operated from a corresponding panel on the alternating current switchboard.

The lighting circuits are on the three-phase system.

Switchboard.—The total length of the switchboard is 69 ft. 4 ins. At the right-hand end of this board are six panels controlling the lighting circuits. These are fitted with measuring instruments and double pole circuit breakers. In addition, the blowers for the air blast transformers are controlled from these panels.

Adjacent to the sixth lighting panel are two instrument panels, carrying instruments connected to the four high tension incoming feeders, and also two polyphase reverse current relays.

ELECTRIC RAILWAY ENGINEERING

Next to the two instrument panels are four alternating current low tension panels for the rotaries. These panels carry the instruments used in connection with the low tension alternating current side, also the controlling switches, and the small motor starting switches.

Following the alternating current panels, are four continuous-current panels for the rotaries. Each of these panels carries a circuit breaker with a reverse current

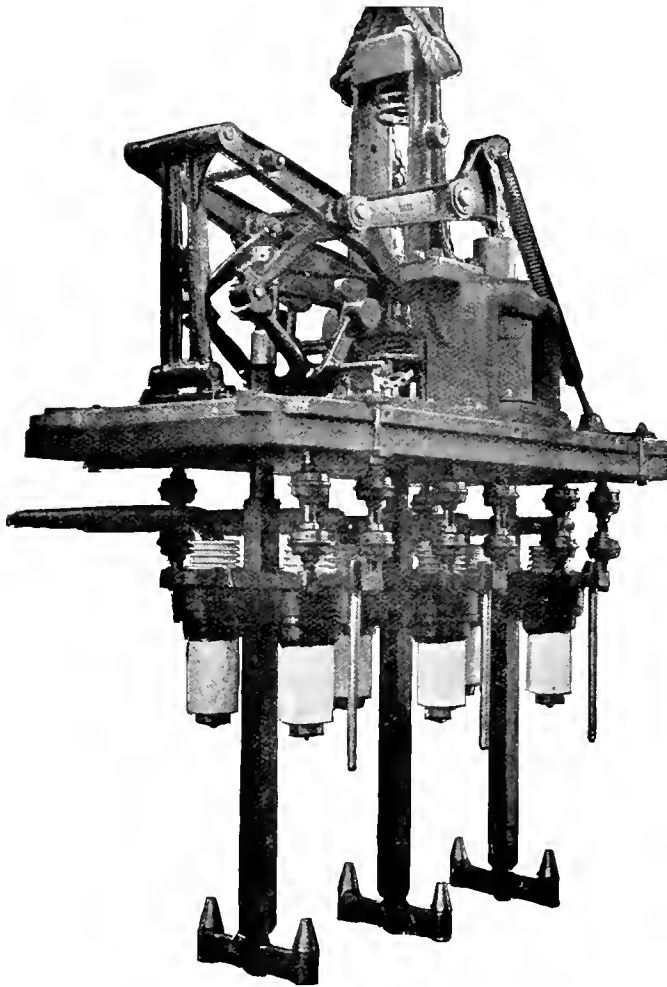

Fig. 200. DISTRICT RAILWAY: TYPE C. OIL SWITCH IN SUB-STATION.

relay attachment, and two single-pole knife switches. These panels also carry the rheostat dial switches for controlling the field windings of the rotary converters. After the continuous-current panels come the main load panels, carrying two large volt meters, one connected across the bus bars and the other to the machine volt meter. This panel also carries the main ammeter. Next to the load panel is the watt meter panel, carrying three large watt meters. Next come the lift panels, which control the supply of current to the lifts. Adjoining the lift panels are placed twelve train section and track feeder panels. Each panel carries two 3,000-ampere circuit breakers, one 4,000-ampere ammeter, and two 3,000-ampere single pole knife switches. The feeders are double pole, as the positive and negative rails are insulated throughout.

The bus bars are of flat copper strips. The low tension series transformers for operating the low tension

alternating current ammeters consist only of a secondary winding and a magnetic circuit. The secondary windings are slipped over the switch studs, which form the primary of these transformers.

The whole of the high tension cables, series transformers, etc., are mounted on a fireproof screen called the high tension wall. A series of small vertical brick cubicles or slots are formed in this wall, in which the cables are run. The high tension bus bars are arranged in similar cubicles. The spark gaps are arranged in a fireproof chamber.

THE SUB-STATIONS

The switches installed for the high tension feeders and rotaries, are operated by means of hand levers. These switches are automatically tripped by relays. The switch is maintained in an open position by gravity. Fig. 200 shows one of these switches. They are erected in a masonry structure, each of their three poles and the oil tank in which they are immersed, being in a separate fireproof compartment.

4. *Sub-stations of the North-Eastern Railway.*

The electrified section of the North-Eastern Railway is served by five sub-stations, having an aggregate capacity of 11,200 kilowatts. They are located respectively at Pandon Dene, Cullercoats, Wallsend, Benton, and Kenton.

Of these the first-mentioned is the largest; it contains four converter units of

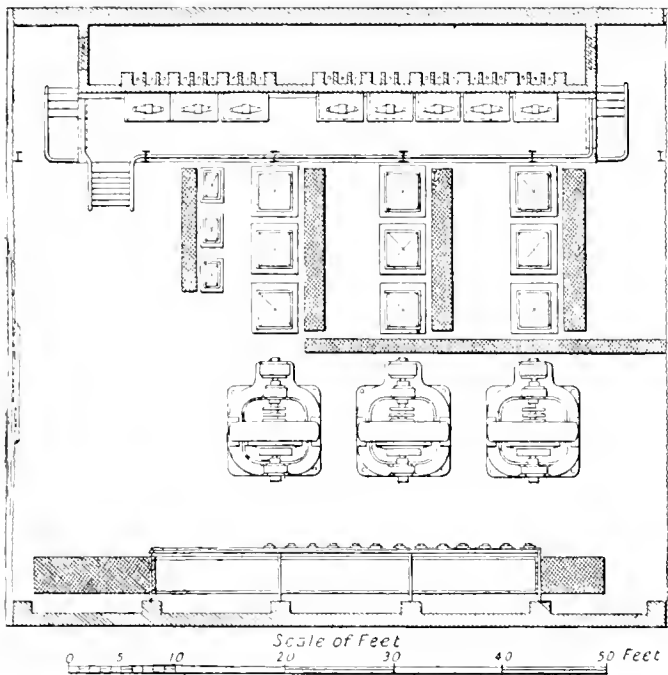

Fig. 201.—NORTH-EASTERN RAILWAY: GROUND PLAN OF TYPICAL SUB-STATION.

800 kilowatts each. Next come Cullercoats and Wallsend, with three similar units; while Benton and Kenton each have two units.

The general arrangement of the sub-stations is shown in Figs. 201, 202 and 203.

The generating station supplies the sub-stations with three-phase currents at a pressure of 5,500 volts, which is reduced by sets of three transformers in delta connection, and is converted by the rotary converters into continuous current at 600 volts, at which voltage the current is supplied to the third rail.

The high and low tension boards are located on opposite sides of the station, the progress of the energy from the high tension lines being thus from one side to the other.

The incoming 5,500-volt feeders (three-core, paper-insulated, lead-covered

ELECTRIC RAILWAY ENGINEERING

cables), are fitted with spark gaps capable of relieving the cables of any abnormal rise of pressure.

The main feeder switches between the feeders and the bus bars, are of the

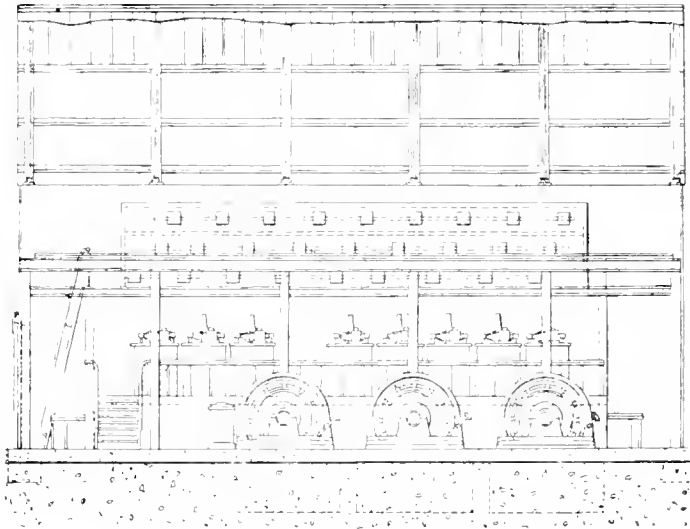

Fig. 202. NORTH-EASTERN RAILWAY: LONGITUDINAL SECTION OF SUB-STATION.

Westinghouse oil-break type, as shown in Fig. 204. These are electrically operated from a low tension board, and are capable of breaking the maximum current of any of

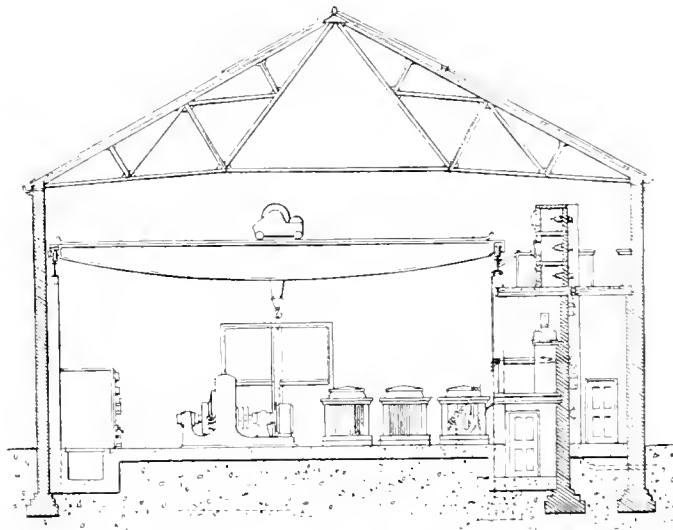

Fig. 203. NORTH-EASTERN RAILWAY: CROSS-SECTION OF SUB-STATION.

the sub-stations. The high tension gear is mounted on a fireproof wall, with partitions between each phase and circuit. In connection with the main feeder switches there are two reverse-current relays and solenoid switches which energise the tripping

THE SUB-STATIONS

coil and open the oil switch in case the current should reverse and the sub-station commence to supply power to the high tension feeders. A nine-panel low tension board is provided for the control of the high tension switch-gear.

Electrically operated oil switches are also interposed between the bus bars and the high tension windings of the static transformers. These are fitted with time-limit overload cut-outs, to open in case of overload or breakdown.

All high tension circuit breakers are provided with isolating switches, to ensure

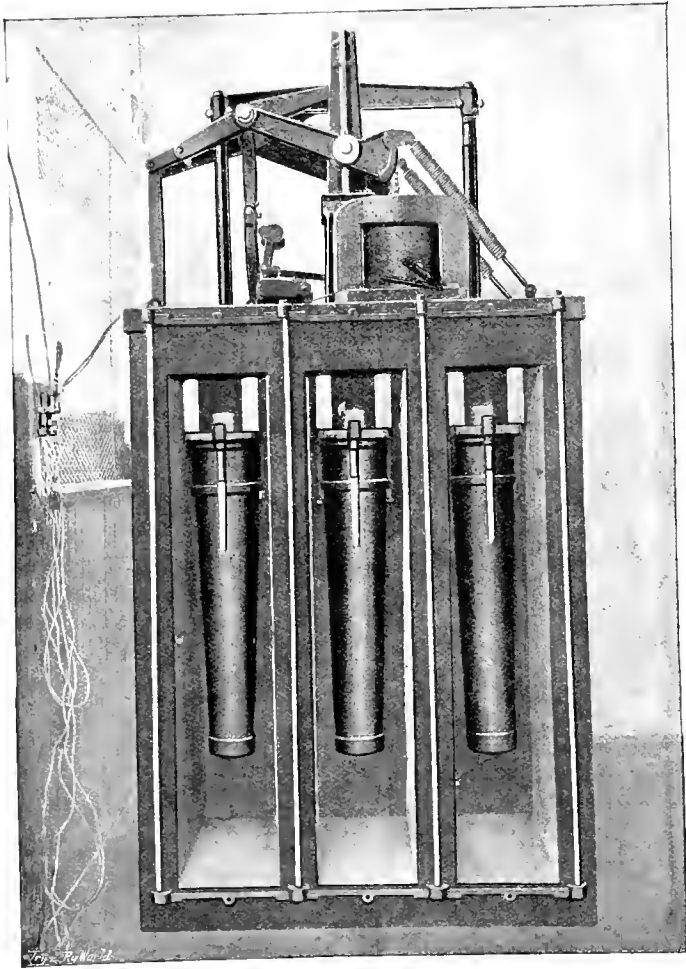

Fig. 204. NORTH-EASTERN RAILWAY: WESTINGHOUSE OIL-BREAK HIGH TENSION SWITCHES.

safety during inspection or cleaning. The current and potential transformers for instruments on the boards, are fixed between the high tension switches and the static transformers, or on the feeder side of the high tension feeder switches, as the case may be. One pole of each instrument transformer is earthed on the low tension side, to avoid any possibility of high tension at the operating board.

The high tension switch-gear for the converter sets is controlled from panels on the large continuous-current board on the side of the station opposite to the high tension gear.

ELECTRIC RAILWAY ENGINEERING

Two panels are required for each converter set, one, as mentioned above, for the high tension side of the transformers, and the other for the direct current side of the rotaries. The group of three transformers and one rotary is treated as a unit, and all synchronising is done on the high tension side. A panel is also set aside for the transformers which supply the induction motors used for starting the rotaries. The load panels on this board carry instruments which measure the total power supplied to the traction feeders. They also carry suitable recording instruments. There are also six panels for the control of as many 600-volt feeders, each being fitted with a moving-coil ammeter, a circuit-breaker, and a knife switch. The negative poles of the machine and feeders are permanently connected to the negative bus bar. A small battery supplies current for operating the switches and for lighting the pilot lamps. The main transformers are of standard Westinghouse oil-insulated and self-cooled pattern. They are each of 280 kilowatts rating at 5,500 to 360 volts and 40 cycles.

The rotary converters, of 800 kilowatts rated capacity each, convert the 360-volt alternating current to 600-volt continuous current. Each rotary converter is a self-contained unit, the two bearings, the lower half of the frame, and the starting motor, being mounted on a common base plate. The temperature rise of the rotary converters, running continuously at rated load, does not exceed 35 degrees Cent., and at 50 per cent. overload, after three hours, 60 degrees Cent. Each rotary is started by a small Westinghouse, Type "C.B." polyphase induction motor with rotor mounted on the armature shaft. This runs the armature up to speed before the main three-phase supply is cut in. Separate step-down transformers are provided for the supply of these motors. The lighting circuit is also supplied from these transformers.

As already mentioned, the group comprising three three-phase transformers and one rotary converter is regarded as a unit. The following table shows the combined efficiencies of transformers and rotary converters, these being the average results of a large number of measurements:—

	Efficiency.
Half-load	91.9 per cent.
Three-quarter load	93.4 ..
Full load	93.9 ..
One-and-half load	93.9 ..

A diagram of the electrical connections at Pandon Dene Sub-station is given in Fig. 205.

5. *Sub-stations on the New York Central Railway.*

The data given in Tables LXX., LXXI., and LXXII., for sub-stations on this line, relate to the New York City suburban section of the system.

The power stations, two in number, are situated at Morris and Yonkers. These generate energy at 11,000 volts and 25 cycles, which is transmitted through mains, partly overhead and partly underground, to the sub-stations already listed in Tables LXX., LXXI., and LXXII. Each sub-station may be fed from either power station, and the lines are so disposed that no ordinary accident can cut off a sub-station from its power supply.

At the sub-stations the high tension current is stepped down to continuous current at 666 volts for delivery to the third rail. The main equipment of each sub-station consists of three rotary converters and their accompanying transformers and

ELECTRIC RAILWAY ENGINEERING

The following general principles were adopted in the design of the sub-stations:—¹

(1) The path of energy to be as direct and as short as possible from the high tension transmission line to the continuous current feeders;

(2) The wiring to be as little exposed as possible and yet to be readily accessible;

(3) All the machinery to be on the same floor as the operating boards;

(4) The principal apparatus to be under the direct control of the operator while standing at the operating boards;

(5) All apparatus and machinery to be so arranged that the effects of an accident shall be confined to the place where it occurs;

(6) The risk of accident to the operator to be as slight as possible; and

(7) Stations to be fireproof.

In pursuance of the first idea, the apparatus is arranged in the following order, across the station:—

Entrance of high tension lines, high tension switching apparatus, transformers, rotary converters, direct current switching apparatus. Along the station there is a succession of complete units, such as that described above, the controlling apparatus being located at the centre. The second requirement necessitated the use of wall chases for the high tension lines, and determined the use of transformers having both high tension and low tension terminals underneath the main floor. The third requirement determined the omission of galleries except for lightning arresters. The fourth requirement introduced the use of electrically operated switches and circuit breakers for both the high tension alternating current and the low tension continuous-current. All of these switches and circuit breakers are operated from the control boards. The fifth requirement determined the ample spacing of the machinery and introduced a very complete system of barriers for the protection of line conductors, thus minimising danger to operators.

Entrance of High Tension Lines.

The underground lines enter the basement through ducts, and are terminated at end bells, where they divide into three separate conductors running to three series transformers which supply current to the measuring instruments. The scheme adopted for the entrance of overhead lines was settled after a careful examination of all systems in use, and is believed to afford the best possible protection against rain and snow, not only to the incoming line, but also to the apparatus in the building.

Lightning Arresters.

The design of the lightning arresters was made with the view of separating the phases as much as possible and to make all parts accessible. The groups of arresters are mounted in such a way that a complete set may be taken out and replaced with the greatest facility, a feature which is believed to be original with this installation.

All overhead lines are provided with knife switches to disconnect them from the sub-station apparatus.

¹ This account is extracted from the *Street Railway Journal* report on the New York Central Railroad, Vol. XXVI., p. 920, November 18th, 1905.

THE SUB-STATIONS

High Tension Wiring and Oil Switches.

The high tension bus compartment is of concrete, and is provided with concrete barriers to separate the lines connected to the buses. The series transformers for the measuring instruments pertaining to lines and machines, are suspended from the ceiling in a row near the bus compartment, and are separated by barriers. In order to obtain this uniform arrangement, and yet leave the front terminals of the oil switch dead when not in use, the high tension lines between the series transformers and the power transformers are looped under the bus compartment, an arrangement which affords a very neat and practical way of combining two advantages which hitherto have not been jointly obtained.

The wiring, where bare, is of copper tubing, which gives an excellent mechanical construction, a feature of special importance for the delta arrangement of the power transformers. The high tension bus bars are supported rigidly, but nevertheless in such a way as to take care of expansion and contraction. All openings in the bus compartment are protected by fireproof doors.

The oil switches are electrically operated, and are designed to carry a substantial overload. They are provided with pilot lamps to indicate at the control board whether they are open or closed, and the lamp circuits are so arranged that there is no indication unless the plungers complete their stroke without rebounding. The compartments are of brick, which matches the interior of the sub-stations, the barriers between phases being soapstone.

Transformers and Rotary Converters.

Two sub-stations are equipped with single-phase 550-kilowatt transformers to supply the 1,500-kilowatt converters, whereas the stations with 1,000-kilowatt converters have 375-kilowatt transformers. These have a normal ratio of 11,000 volts to 460 volts, and are provided with extra taps for varying the voltage according to the drop in the transmission lines, or according to the distribution of load among the sub-stations. They are of the air-cooled type, with terminals underneath. The air is supplied by two induction-motor-driven blowers, one of which suffices to supply the station.

The rotary converters are of the sextuple connection three-phase type, which combines the advantages of the ordinary three-phase and six-phase type. They convert the alternating current at 460 volts into continuous current at 666 volts.

Continuous-Current Switchboards.

These will have motor-operated switches and circuit breakers, controlled from the boards at the centre of the station. The design of these switches and breakers is stated to ensure a certainty, rapidity, and safety of action hitherto unknown with this type of apparatus. A spare panel and auxiliary bus are provided, to which any feeder or machine may be connected pending repairs on its proper panel. All connections are made with copper bars, thereby ensuring a neat and effective construction.

The positive feeders after leaving the switchboards, are provided with end bells, which terminate the lead sheathing of the cables which run out to the third rail in underground ducts.

The negative leads from the converters, run through the foundations and connect

ELECTRIC RAILWAY ENGINEERING

to an ammeter shunt which carries the entire station output. The negative feeders are bare 2,000,000-circ.-mil cables, which run out directly to the tracks in pipes.

There are two controlling boards situated at a part of the station which will be the centre when the station is extended to its final limits. There is a bench board which carries the principal instruments and control apparatus, whereas an upright board carries the auxiliary control apparatus for lighting, etc. All panels are of natural slate, with black finish, the instrument cases being black oxidised.

Cranes.

Each sub-station is provided with an electric travelling crane, which is also supplied with arrangements for hand operation.

Storage Battery Equipment.

The electric storage battery equipment is believed to be the largest railway battery installation in the world. It not only takes care of load fluctuations, but it is sufficiently large to operate the entire system under normal conditions for a period of 1 hour in case of failure of generating apparatus. Five of the batteries have an output each of 2,250 amperes for 1 hour, and the others give 3,000 amperes, 3,750 amperes, and 4,020 amperes respectively.

The batteries are located in buildings adjoining the sub-stations, and are operated in connection with boosters and switching apparatus in the sub-station.

The discharge is governed by a carbon regulator, working in connection with exciters and boosters, the effect of which is to make the batteries discharge when there is heavy demand for current and to charge when the demand is light.

The battery houses are of the most modern construction, and have acid-proof floors of vitrified brick. The heating and ventilating systems are of the most approved type, and are well protected against acid fumes.

Starting Converters.

Converters may be started either from the continuous-current or alternating current side. In the latter case a gradual application of voltage is ensured by taking current from several taps in the secondaries of the power transformers. Starting from the continuous-current bus, the machine is started as a continuous-current motor through a rheostat. When a speed above synchronism is reached, the continuous-current circuits, including the shunt field, are opened, and the machine runs by its momentum only. The alternating current is then put on by closing the oil switch, and the machine runs as a synchronous motor. It is then only necessary to close the shunt-field circuit to put the machine in synchronism. These operations are made to follow each other rapidly, and are effected by the use of a special combination switch.

Lighting.

Sub-station lighting is done with incandescent lamps operated by alternating current at 120 volts. The current is taken from the 460-volt power circuits and the voltage reduced by special transformers. The lights are distributed so as to illuminate all apparatus, and at the same time give a good general illumination. All wiring is in

THE SUB-STATIONS

conduit, and circuits are controlled from standard panel boxes set in the walls. The lighting of battery rooms has been developed with a view to protection from acid fumes, all wiring in these rooms being lead-covered and all sockets of porcelain. Emergency lighting current may be taken from the control battery or charging set.

Continuous-Current Feeder System.

The continuous-current feeder system is designed to give a duplicate path for the current from the sub-station to the third rail. It is also designed so as to confine any trouble which may occur, to one track only, thereby making any interruption of traffic as slight as possible. Switches are provided at the third rail to disconnect all feeders at that point in case of a ground between the rail and the station. A train length section of third rail is separately fed from the sub-station, and is designed to prevent trains bridging between sections. All continuous-current cables are installed in tile conduits close to the tracks, except the auxiliary feeders which join the sub-station buses and supplement the conductivity of the third rails. These are, in some localities, run overhead on the transmission poles.

The four third-rails and auxiliary feeder are joined together through circuit breakers situated in small houses at intervals along the line, thereby increasing the effective conductivity.

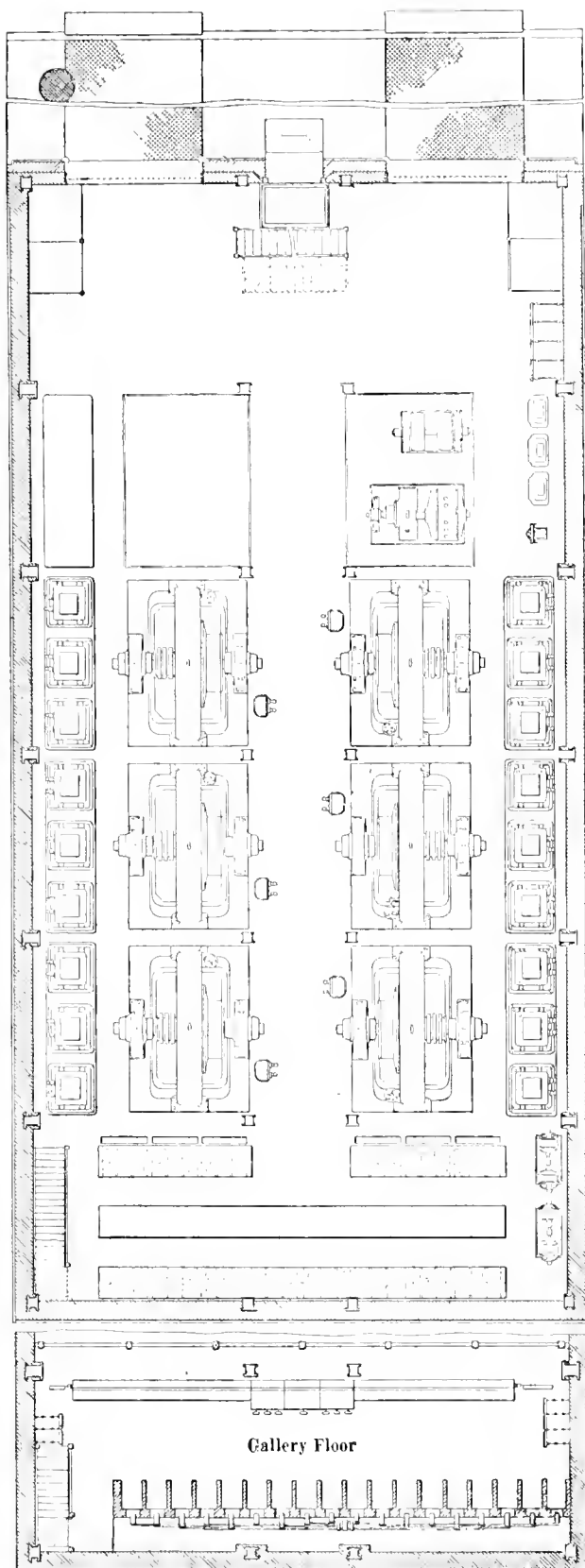

Fig. 206. NEW YORK SUBWAY: CONVERTER FLOOR-PLAN OF SUB-STATION No. 14.

ELECTRIC RAILWAY ENGINEERING

6. *Sub-stations of the Interborough Rapid Transit Co.; New York Subway.*

A list of sub-stations and corresponding data for each, is given in Tables LXX., LXXI., and LXXII.

The converter unit employed to receive the alternating current and deliver direct current to the track, etc., has an output of 1,500 kilowatts, with ability to carry 50 per cent. overload for 3 hours. The average area of a city lot is 25×100 ft., and a sub-station site comprising two adjacent lots of this approximate size, permits the installation of a maximum of eight 1,500-kilowatt converters with necessary transformers, switchboard, and other auxiliary apparatus.

In designing the sub-stations, a type of building with a central air well was

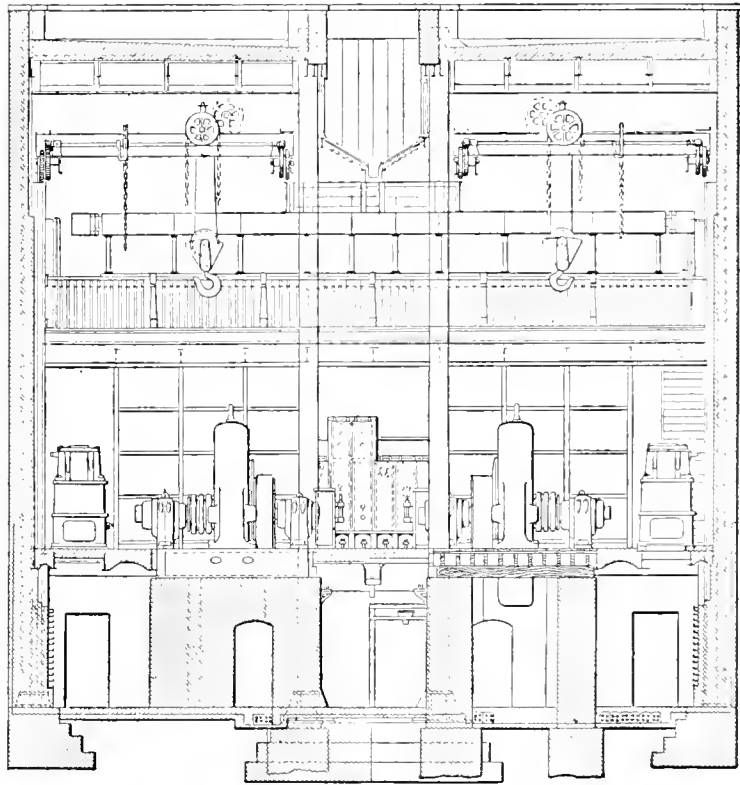

Fig. 207. NEW YORK SUBWAY: CROSS-SECTION OF SUB-STATION No. 14.

selected. The typical organisation of apparatus is illustrated in the ground plan and vertical sections in Figs. 206, 207, and 208, and provides, as shown, for two lines of converters, the three transformers which supply each converter being located between it and the adjacent side wall. The switchboard is located at the rear of the station. The central shaft affords excellent light and ventilation for the operating room. The steel work of the sub-stations is designed with a view to the addition of two storage battery floors should it be decided at some future time that the addition of such an auxiliary is advisable.

The energy is delivered to the line in the form of three-phase current at 11,000 volts.

THE SUB-STATIONS

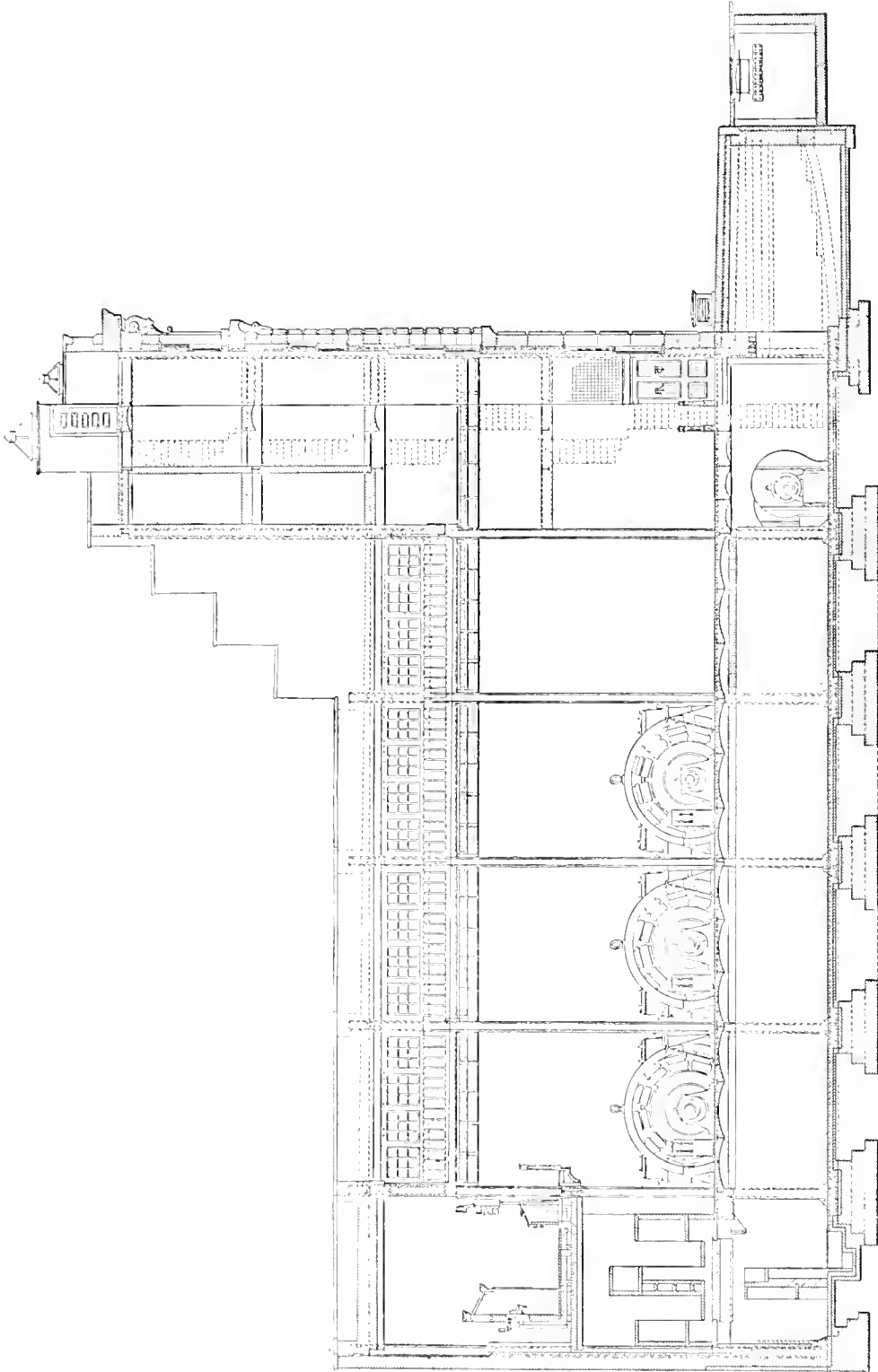

Fig. 208. NEW YORK SUBWAY: LONGITUDINAL SECTION OF SUB-STATION No. 14.

ELECTRIC RAILWAY ENGINEERING

The sub-station apparatus comprises transformers, converters, and certain minor auxiliaries. The transformers, which are arranged in groups of three, receive the three-phase alternating current at a potential approximating 10,500 volts, and deliver equivalent energy (less the loss of about 2 per cent. in the transformation), to the converters at a potential of about 390 volts. The converters receiving this energy from their respective groups of transformers, in turn deliver it (less a loss approximating 4 per cent. at full load) in the form of direct current at a pressure of 625 volts, to the bus bars of the continuous-current switchboards, from which it is conveyed by insulated cables, to the contact rails.

The illustration in Fig. 209 is from a photograph taken on one of the switchboard galleries. In the sub-stations, as in the power-house, the high pressure alternating current circuits are opened and closed by oil switches, which are electrically operated

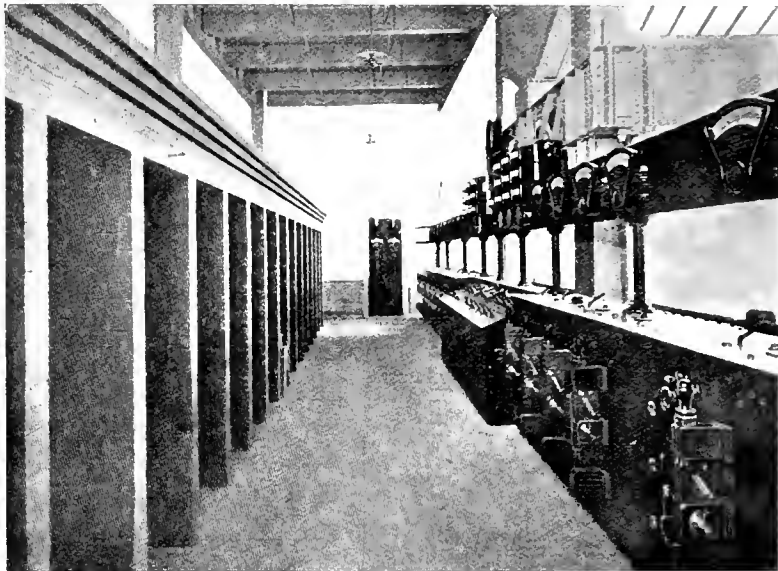

Fig. 209. NEW YORK SUBWAY: OPERATING GALLERY IN SUB-STATION.

by motors, these in turn being controlled by 110-volt continuous-current circuits. Diagrammatic bench boards are used, as at the power-house, but in the sub-stations they are, of course, relatively small and free from complication. The instrument board is supported by iron columns, and is carried at a sufficient height above the bench board to enable the operator, while facing the bench board and the instruments, to look out over the floor of the sub-station without turning his head. The switches of the continuous-current circuits are hand-operated, and are located upon boards at the right and left of the control board.

A novel and important feature introduced in these sub-stations is the location in separate brick compartments of the automatic circuit breakers in the continuous-current-feeder circuits. These circuit-breaker compartments are shown in the photograph in Fig. 209, and are in a line facing the boards which carry the continuous-current-feeder switches, each circuit breaker being located in a compartment directly opposite the panel which carries the switch belonging to the corresponding circuit. This plan

THE SUB-STATIONS

will effectually prevent damage to other parts of the switchboard equipment when circuit breakers open automatically under conditions of short circuit. It also tends to eliminate risk to the operator, and, therefore, to increase his confidence and accuracy in manipulating the hand-operated switches.

The three conductor cables which convey three-phase currents from the power-house are carried through tile ducts from the manholes located in the street directly in front of each sub-station to the back of the station where the end of the cable is connected directly beneath its oil switch. The three conductors, now well separated, extend vertically to the fixed terminals of the switch. In each sub-station but one set of high potential alternating current 'bus bars' is installed, and between each incoming cable and these 'bus bars' is connected an oil switch. In like manner, between each converter unit and the 'bus bars' an oil switch is connected into the high potential circuit. The 'bus bars' are so arranged that they may be divided into any number of sections not exceeding the number of converter units by means of movable links, which, in their normal condition, constitute a part of the 'bus bars'.

Each of the oil switches between incoming circuits and 'bus bars' is arranged for automatic operation, and is equipped with a reversed current relay, which in the case of a short circuit in its alternating current feeder cable opens the switch and so disconnects the cable from the sub-station without interference with the operation of the other cables or the converting machinery.

The Location of Sub-stations.

Carter has laid down in an interesting manner some important considerations which should control the location of sub-stations. To quote from his paper,¹

“In a system of any size there will usually be certain junctions from which several lines radiate, and which accordingly form natural distributing points, where one would locate sub-stations if otherwise practicable. One must also locate a sub-station near each of the ends of a line, since, with the usual arrangement of low-tension feeders, the distance that one can feed to a dead end with a given drop in potential is only about one-third of the distance between adjacent sub-stations on the line. Sub-stations should, wherever possible, be located at railway stations, for the convenience of attendants, inspectors, and visiting engineers, and to facilitate the delivery of supplies.

“The above considerations having been taken account of, and local conditions fully allowed for, the sub-stations should be located with reference to the potential drop between sub-stations and trains. In the case of a completely insulated line equipment, such as that employed on the Metropolitan and Metropolitan District Railways, the waste of energy limits the mean voltage drop, whilst the necessity of efficient train lighting at all times limits the maximum. With a rail return, however, there are the additional restrictions imposed by the Board of Trade on the voltage drop in uninsulated conductors.

“The position of the trains with reference to the sub-stations should be mapped out, and the voltage drop in the conductor rails at any particular time determined. This should be done for a time of heavy load, and the worst condition to be anticipated in regular service should be judged, due allowance being made for probable future increase of traffic.

¹ “Technical Considerations in Electric Railway Engineering,” paper read before the Institution of Electrical Engineers, January 25th, 1906.

ELECTRIC RAILWAY ENGINEERING

“The location of the sub-stations will in the end be a matter of considerable adjustment and compromise, the object being to efficiently feed the system, employing as few sub-stations as practicable. On a system with many ramifications it is often impossible to prevent the sub-stations crowding one another somewhat in certain places, but, with care, the layout can usually be made so that there is not very much waste from this cause.

“In a continuous-current system, the all-day efficiency of distribution from generating station bus bars to trains, is usually in the neighbourhood of 78 per cent. In a well-designed alternating-current system this efficiency would probably approximate to 87 per cent.”

Mr. Carter is of opinion, and the authors most emphatically share the opinion, that this last-named advantage of systems employing single-phase equipments is more than thrown away when the rolling stock is considered. Indeed, while involving considerations which belong to a later chapter, we wish here to refer to another paragraph of Mr. Carter's paper which reads as follows :—

“We can now see why, under suburban conditions, the single-phase system compares very unfavourably with the continuous-current system. What with the heavier train and the greater energy consumption per ton-mile, the energy consumption per train mile, for trains of given capacity, will generally be quite 45 per cent. greater under single-phase than under continuous-current operation. Allowing for the higher efficiency of distribution in the former of these systems, the power and energy generated must still be some 30 per cent. greater. This requires 30 per cent. greater capacity in the generating plant, the cost of which will almost wipe out the saving in the sub-stations, whilst the 30 per cent. greater annual generating costs will far exceed any possible saving in sub-station maintenance and supervision. In a compact system operating frequent trains—such as the usual urban system—the sub-station expenses are insignificant. The following proportions have been found to hold in reference to the Manhattan Elevated Railway :—

Generating and sub-station expenses :—

Maintenance, power-station	9.0 per cent.
Operation, power-station	85.0 ..
Maintenance, sub-stations	0.5 ..
Operation, sub-stations	5.5 ..
	100.0

“In estimating the capacity of the machinery in the several sub-stations, the number of trains fed by each sub-station at all times, must be estimated. A table should be drawn up showing the momentary maximum and average load on each sub-station, both at the time of heaviest traffic and at the time of light load. The output of the sub-station may be taken as 5 per cent. in excess of the input to the trains. The maximum momentary output may generally be taken as occurring when two trains are taking their maximum accelerating current, and all other trains that can possibly be supplied from the sub-station are taking their average current. This rule is, however, subject to modification according to the locality of the sub-station.

“When the above-mentioned table has been drawn up, the size and number of units in each sub-station can be determined. If possible, units of one size should be employed throughout the system, even if the capacity is sometimes greater than is

THE SUB-STATIONS

absolutely necessary. The maximum momentary output of the sub-station should be taken to correspond with the maximum momentary overload of the machines in use. The load at times of heaviest traffic will indicate the number of units required, and the output during the time of light traffic will be found useful in determining the size of the units. Having settled upon the number of machines required for service, an extra one or two will usually be included in each sub-station to serve as a standby.

“In the case of rotary converter sub-stations, the total capacity of the installed machinery will usually be some 40 or 60 per cent. greater than that installed in the generating station for supplying power to the trains. The excess is chiefly required on account of the exceedingly bad load factor of a sub-station, which necessitates an installation far greater than the mean load would indicate. In this respect, the transformer sub-stations of a purely alternating-current system show to great advantage. Transformers can be designed to stand five or six times the rated load for short periods without injury or excessive voltage drop, and two or three times for an hour or two without excessive heating. In such a system, therefore, the continuous capacity of sub-station plant will usually be less than that of the generating station plant, since the former may be laid out to suit the mean all-day load, whilst the latter must suit the mean load at the time of the heaviest traffic”.

Chapter VIII

THE DISTRIBUTING SYSTEM

BY distributing system we mean that part of the electrical system separate from the generating or transmission systems and designed for controlling and regulating the voltage more or less independently of the voltage in the generating or transmission systems. Copper feeders may or may not be a necessary part of the distribution system, which may consist of either an insulated transmission rail with track return or of an overhead conductor with track return, or of either with an insulated return rail. Whenever the return is insulated, track feeders and the attendant disadvantages may be dispensed with, and this rule applies practically independently of the distance between feeding points. It will be seen that in practice the rail becomes an important part of practically any distribution system. This comes about from the fact that at high speeds a degree of rigidity is required in the collector system that is favourable to economical use of iron and steel as conductors. While the voltage in the transmission system may be allowed to vary to correspond with an economical use of materials, there are other conditions imposed by proper operation in the distribution circuit; for this reason the conductance of the distribution system must be relatively very high and cannot be widely varied to suit the economical working of material. Approximately constant voltage must be maintained in the operating circuit to ensure proper performance of train equipment. For this reason, together with the mechanical requirements, rails of very considerable cross-section are used, and in the best practice the drop in these rails rarely exceeds 2 or 3 per cent. of the pressure on the distributing circuit. The collecting device in the low tension system generally consists of shoes, which may be either under-running or over-running. With this class of collector, the surface is so considerable that practically any amount of current may be transmitted to a train without arcing or flashing, except when the most ordinary mechanical precautions are neglected. The chief objection which has been urged against a third rail system relates particularly to first cost, since even with the protected form, not more than 1,000 volts difference of potential between the conductor and rail is considered practical, even when the conductor rails are protected in the most efficient manner. In the case of the overhead system it is urged by its advocates that there is practically no limit to the safe working voltage. It remains to be proved by practical experience whether or not with the same conditions as to regulation, the overhead system is not more costly than the third rail system, since in general the third rail system has been designed with a small drop in pressure, whereas the overhead systems are generally designed with a considerable drop in pressure. The cost of maintenance of rail conductor systems has proved in practice

THE DISTRIBUTING SYSTEM

negligible, whereas the maintenance of overhead systems is a considerable item in working cost.

Preference is expressed by some railway engineers for some form of overhead construction, thus leaving the track clear of obstacles to the repair and upkeep of the permanent way, and also avoiding complications at junctions and termini. There are, however, a number of difficulties attendant upon the use of overhead construction, more especially with reference to high speed and to the small clearance under bridges and tunnels, which appear to have been overlooked. In order to allow of high speed, the conductor must be as free as possible from lateral movement, and at the same time must be flexibly suspended; this is accomplished by suspending the conductor from a cable stretched longitudinally along and at a suitable height above the track. The bridges and tunnels offer considerable difficulties to overhead construction owing to the limited head-room, and in extreme cases the conductor is transferred from above to the track level. The overhead conductor in these cases is sectioned and disconnected from the source of supply and the current collected from a rail by a contact shoe. Provision for these requirements makes the high tension overhead system expensive, and may introduce great difficulties to safe or reliable working. One great advantage resulting from carrying the conductor overhead when placed at a uniform safe distance from the train, is that the conductor can with safety be charged to a higher voltage.

The overhead system for railways is, by many, associated with alternating current motor equipments; there is, however, no essential connection between the two. Hitherto the vast bulk of electric traction throughout the world has been done by continuous current motors, and a pressure of from 500 to 1,000 volts between collector rail and earth has been found to satisfy the economical conditions and to be satisfactory practice. 1,000 volts may be taken to be the safe limit of E.M.F. for rail systems as now constructed. Should the conditions demand it, there is no inherent difficulty in building motors for from 1,500 to 2,000 volts, which will stand the conditions to which railway motors are subject; two such motors placed in series would admit of a line pressure of from 3,000 to 4,000 volts, at which pressure the current required to work the train is within the limits which can be transmitted by copper conductors of ordinary sizes and collected with trolley or bow. The limitations of the overhead system as to high speeds and heavy working, apply equally to both the alternating and continuous current systems.

In distribution by alternating currents, regard must be had to their inductive action; we have to take account of the self-induction of the current on itself within the conductor, as a result of which the current tends to confine itself to the outer layers, and thereby increases the effective resistance of the conductor. This effect is negligible in copper conductors up to one half square inch cross section at a frequency of 25 cycles per second, which is the maximum frequency likely to be used in alternating current traction. Where, however, iron enters into a circuit, the effect is most pronounced, owing to the permeability of the material, and is of such magnitude that it cannot be neglected. There remains to be considered also the inductance of the circuit formed by the conductors, the effect of which, owing to the distance between the conductors, especially where one conductor is carried overhead, is considerable. There are other minor effects which are quite negligible, and need not be specified; the more important effects referred to above, will be dealt with quantitatively in subsequent sections of this chapter.

Since the track rail is extensively employed for conducting the current back from

ELECTRIC RAILWAY ENGINEERING

the motors to the point of supply, it is necessary to deal with the properties of a track as a conductor. We do not, however, deem it necessary to deal with the construction of the track generally, but only with such matters as are incidental to the use of the track as a conductor.

THE THIRD-RAIL SYSTEM.

The material of the third rail is chosen principally with reference to high conductivity, so far as cost permits, and with but little reference to wear, since it is only subject to the friction of a contact shoe pressed against it by gravity or occasionally by a comparatively light spring pressure. The strength of the section is of little importance, any section which is readily installed and insulated being suitable so far as relates to mechanical strength. The rail should be of sufficient cross-section to carry the current without undue voltage drop, and should present an ample contact surface for the collecting shoes. The chemical composition

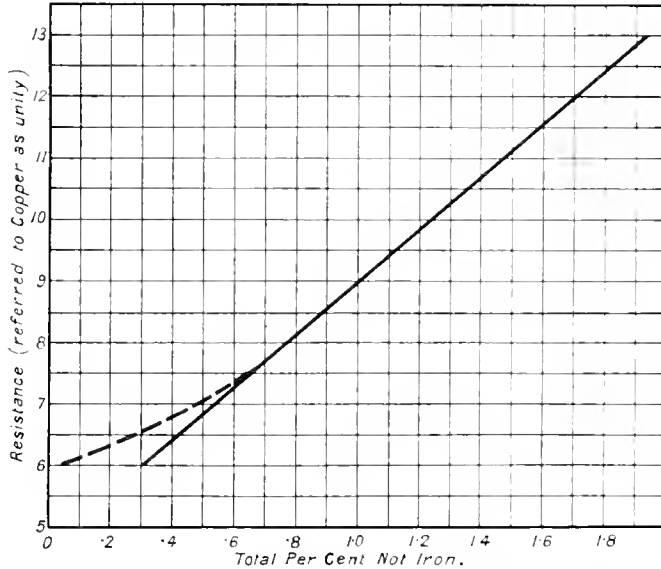

Fig. 210. CURVE FOR RESISTANCE AND COMPOSITION OF STEEL.

customarily employed, and the corresponding specific resistance, are set forth in Table LXXIII., on p. 248, the data in which relate to several third-rail systems. The composition employed in usual practice approximates to the following:—

Carbon	0.09 per cent.,
Manganese	0.44
Phosphorus	0.088
Sulphur	0.080

The resistance of a rail of this composition is about 7.3 times that of copper. It is instructive to compare the constituents of conductor rails with those of track rails, given later on in this chapter. In the case of conductor rails, as mentioned above, the material is chosen especially with reference to a high conductivity rather than to mechanical properties, and on this latter account, the quantity of material

THE DISTRIBUTING SYSTEM

other than iron, present in track rails often reaches 1.5 per cent. (see pp. 267 to 271), while in conductor rails the quantity of other material present, as may be seen from Table LXXIII., on p. 248, averages 0.5 per cent., and rarely exceeds 0.7 per cent. The resistance of such track rails is about eleven times that of copper, while that of conductor rails is only about seven times that of copper. Generally speaking, the resistivity of a rail varies more or less in proportion to the amount of foreign material present, but the cost of manufacturing a very high purity steel outbalances the gain in conductivity resulting therefrom, and hence a compromise is made between high conductivity and the cost of manufacture.

While the resistance of pure iron is only about five times that of copper, the average for conductor rails is about seven times that of copper, which is not a great

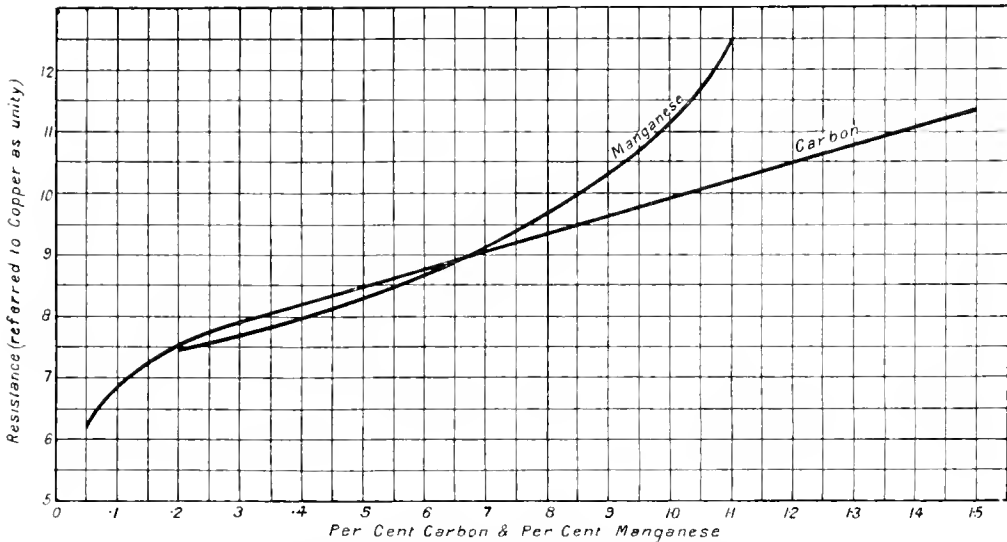

Fig. 211. CURVES SHOWING THE EFFECT OF CARBON AND MANGANESE ON THE CONDUCTIVITY OF STEEL.

amount higher than the resistance of pure iron. Fig. 210 gives a curve showing the effect of foreign matter on the resistance of steel. This curve is deduced from a large number of test results of the General Electrical Co. of America,¹ and of Barrett, Brown, and Hadfield. It may be taken as giving fair values for any given percentage of total impurities, although, of course, the prevalence of each particular foreign element has its own characteristic effect on the resistance. To investigate the effects of such single elements, the tests carried out by the General Electrical Co. of America were made on a large number of samples of widely varying composition. By examining the samples with different proportions of, say, carbon, but with nearly constant proportions of other elements, the effect on the resistance, of varying the percentage of carbon could be studied, and in a similar way the effect of varying the percentage of any other element present.

¹ See paper by J. A. Capp, entitled "The Electric Conductivity of Steel," read before the American Institution of Mining Engineers, 1904.

ELECTRIC RAILWAY ENGINEERING

Barrett, Brown, and Hadfield have ascertained that an increase in manganese from 0·5 per cent. upwards occasions a rapid increase in the resistance at first, and then more slowly until 7 per cent. of manganese is reached, after which the addition of more manganese has little or no effect.

The effect of carbon is to increase the resistance directly in proportion to the percentage of carbon present. The curves shown in Fig. 211 indicate generally the quantitative effects of these two elements.

The curve marked "Manganese" is for rails possessing a fairly low and constant quantity of carbon (from 0·2 per cent. to 0·33 per cent.), the manganese being the principal variable between the limits set forth on the abscissæ of the curve. The curve marked "Carbon" is for rails containing a fairly low and constant quantity of manganese (from 0·2 per cent. to 0·5 per cent.), the carbon being the principal variable element.

Other elements present, *i.e.*, sulphur, phosphorus, and silicon, are only permitted in such small quantities that the effect of their variation is fairly negligible.

Table LXXIII. gives the chemical composition and conductivity of the conductor rails on several representative railways.

TABLE LXXIII.

Composition and Conductivity of Conductor Rails.

Railway.	Percentage Composition of Rail.					Total per cent. not Iron.	Conductivity.		
	Carbon	Manganese.	Sulphur.	Phosphorus.	Silicon.		Ratio of Specific Resistance of Rail to Specific Resistance of Pure Copper at 20° C.	Microhms per Inch Cube.	Resistance of 1 Mile 1 Square Inch in Section at 20° C.
Central London . .	·03	·33	·045	·052	Traces	·457	7·50	4·94	·313
Baker Street and Waterloo	·05	·19	·05	·05	·03	·370	6·40	4·25	·269
Manhattan . . .	·073	·340	·073	·069	Nil	·555	7·750	5·150	·326
New York Subway .	·10	·60	·05	·10	·05	·90	8·00	5·30	·336
Boston Elevated .	·037	·341	·073	·069	Nil	·520	—	—	—
Metropolitan and District	·035	·315	·059	·056	Nil	·465	—	—	—
Great Northern and City	—	—	—	—	—	—	7·15	4·42	·280
New York Central .	—	—	—	—	—	—	7·50	4·94	·313

Mounting of Conductor Rails.

The method of mounting and insulating the conductor rail and the design of the insulator depend largely upon the shape of the rail section.

The insulating supports on which the rail rests are usually spaced from 4 to 12 ft. apart.

Some examples are given in Table LXXIII.A. for four London lines.

THE DISTRIBUTING SYSTEM

TABLE LXXIII.

SHOWING SPACING OF INSULATING SUPPORTS.

Railway.	Distance in Feet between Insulators.	Number of Insulators per Mile of Conductor Rail.
Metropolitan and District	10.5	503
Central London	7.5	705
City and South London	6.5	812
Waterloo and City	7.5	705

The weights per yard of the various conductor rails together with a number of other particulars of the track may be found by reference to Tables LXXIV., LXXVII., and LXXVIII.¹

TABLE LXXIV.

Particulars of Conductor Rails for various Railways.

Designating Number.	Railway.	Particulars of Conductor Rail.			
		Length in Feet.	Weight in Pounds per Yard.	Cross-section. See Fig. 222, on p. 258.	Area, Cross-section in Square Inches.
1	Paris Metropolitan	—	93	—	9.15
2	New York Subway	40 and 60	75	A	7.38
3	Boston Elevated	60	85	A	8.37
4	Central London	30 and 42	85	D	8.37
5	Great Northern and City Railway	42	80	D	7.87
6	Lancashire and Yorkshire Railway	60	70	A	6.9
7	Berlin Electric Overhead and Underground	39 ft. 4½ ins.	56.5	A	5.6
8	Berlin-Zossen	—	—	—	—
9	Valtellina	—	—	—	—
10	City and South London	30	40	D	4.0
11	Baker Street and Waterloo Railway	—	85	E	8.37
12	Petaluma and Santa Rosa Railway, California	—	—	—	—
13	Milan-Varese-Porto Ceresio Railway, Italy	39 ft. 4 ins.	90.7	A	9.2
14	St. Georges de Commaires la Mure, France	—	—	—	—
15	Liverpool Overhead	32	—	—	4.0
16	Mersey Railway, Liverpool	60	100	T section	9.8
17	Manx Electric Railway, Douglas-Ramsey	—	—	—	—
18	Seattle-Tacoma	30	100	A	9.8
19	Jackson and Battle Creek Railway	30	70	A	6.9
20	Manhattan Elevated	60	100	A	9.8
21	Metropolitan District Railway	—	100	A	9.8
22	London, Brighton, and South Coast Railway	—	—	—	—
23	New York Central	—	70	B	6.9
24	Paris-Versailles	59	94	B	9.26
25	North-Eastern	—	80	B	7.8

The material of the insulators themselves, should combine mechanical strength and durability with good electrical insulating properties. As these two properties do not usually exist together, it is somewhat difficult to obtain a satisfactory material.

The material in most common use is of the earthenware variety. Thus the

¹ For Table LXXVII. and LXXVIII., see p. 272.

ELECTRIC RAILWAY ENGINEERING

Baker Street and Waterloo Railway employs vitrified earthenware; the Central London Railway and the Metropolitan and District Railways of London are

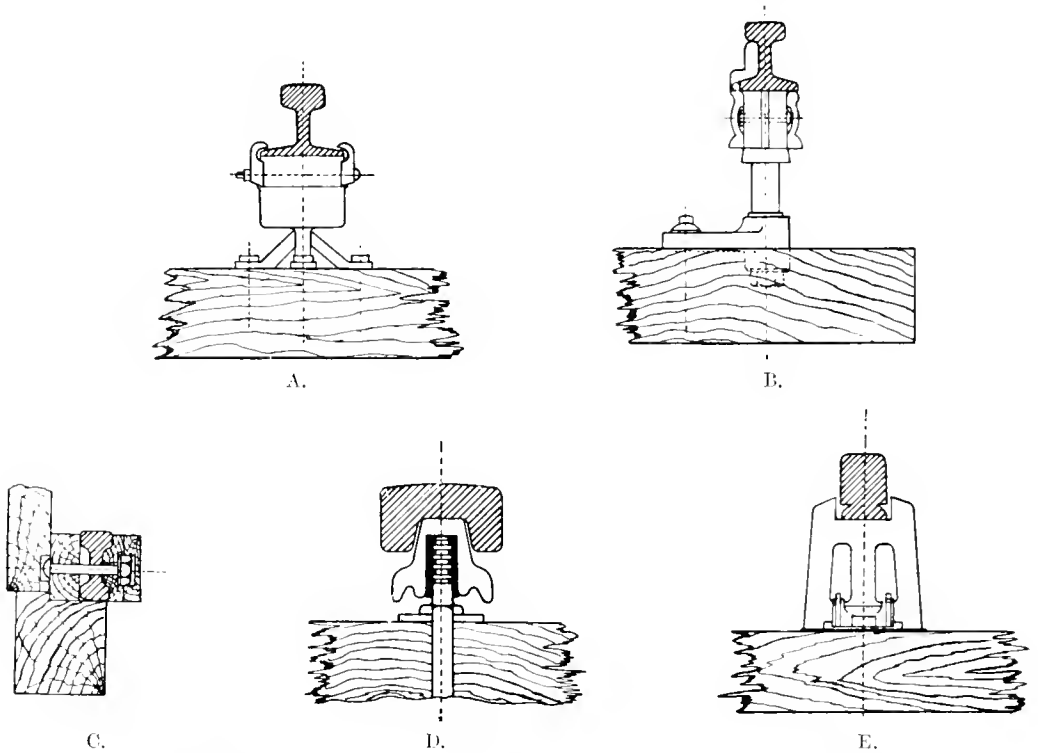

Fig. 212. METHODS OF MOUNTING AND INSULATING CONDUCTOR RAILS.

employing highly vitrified porcelain. These insulators were manufactured by Messrs. Doulton.

The New York Central Railway, which has adopted the under-contact type of conductor rail, described hereafter, is still experimenting with the following substances with a view to finding the most suitable: vitrified clay, rubber and indurated fibre and reconstructed granite. Reconstructed granite is employed on the Manhattan Elevated Railway.

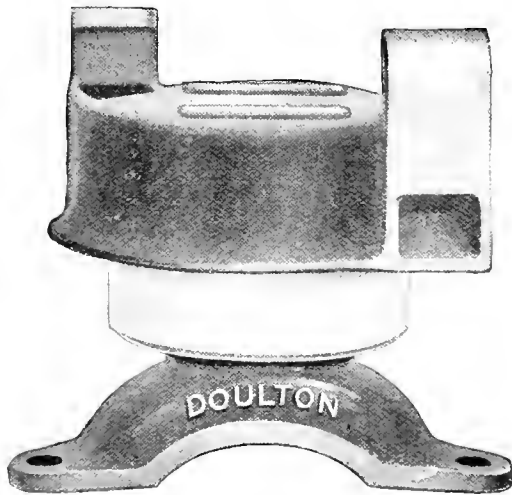

Fig. 213. CONDUCTOR RAIL INSULATOR. LONDON UNDERGROUND ELECTRIC RAILWAYS Co.

which show sections through various tracks, will be instructive in this connection.

THE DISTRIBUTING SYSTEM

The methods set forth in Fig. 212 are lettered A, B, C, etc., and a reference to column 3 of Table LXXV. will show the method in use on many of the roads enumerated in that table. The commonest method (Fig. 212A) of mounting a flat-bottomed rail, is on a cylindrical drum insulator, with some kind of overhanging tip clamping the bottom flange of the rail. A view of the London Underground Electric Railways Co.'s insulator is shown in Fig. 213. This consists of a black or cream enamelled vitrified stoneware of Messrs. Doulton's manufacture, with base and cap of malleable cast iron.

The method shown in Fig. 212c is employed on the Paris-Orleans Railway, where a bull-headed rail is mounted and insulated on timber.

Fig. 212b shows mounting for a rail of channel section, as on the Central London Railway and on the City and South London Railway. The channel rail covers in the insulators, thus protecting them, and giving a highly satisfactory arrangement. It is surprising that the channel rail has not been used to a greater extent, as it has proved more satisfactory than any others, in cases where it is employed.

For mounting a solid type rail Fig. 212E shows a simple solution, where the rail is laid on earthenware insulators bolted on to the sleepers with wrought iron clips. This type of rail and mounting is used on the Baker Street and Waterloo Railway, the solid square section being employed to save space, an important matter in a tube railway, and at the same time to get a large cross-section of rail.

Wood is inferior to other insulating materials on the grounds of destructibility by weather and low durability.

In designing the insulators, they should be relieved of undue stress, and should permit of sufficient freedom to the rail with regard to expansion, irregularities of track construction, and so forth.

Fig. 214 shows another Doulton pedestal type insulator, somewhat similar to those employed on the District Railway.

In Fig. 215 are shown two types of insulator by the Reconstructed Granite Co. The lower illustration in this figure relates to a solid insulator for flat-bottomed rails.

Fig. 216 shows Chambers' insulator for a rail of tapered channel section, which latter has been adopted by the Great Western Railway for their metropolitan lines.

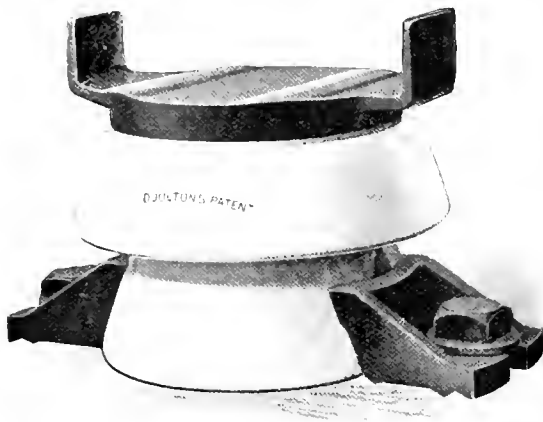

Fig. 214. PEDESTAL TYPE OF RAIL INSULATOR.

Protection of Live Rails.

A bare exposed 500-volt conducting rail is sometimes required to have some mode of protection against anything falling on it and causing short circuits on the return rails, and also from the point of personal safety to the railway company's servants and of trespassers. Although a potential of 500 volts is rarely

ELECTRIC RAILWAY ENGINEERING

fatal to human life, the fact remains that a few fatal accidents have occurred, of which a 500-volt live rail has been the primary cause. Hence there have been many



Fig. 215 RECONSTRUCTED GRANITE CO.'S INSULATORS.

THE DISTRIBUTING SYSTEM

attempts to effectively guard the conductor rail against wilful tampering and accidental contact.

Fig. 217 illustrates a number of typical methods which have been employed for guarding the live rail. The types are indicated by the letters A, B, C, and D, and corresponding letters appear in column 4 of Table LXXV., thus indicating the methods of guarding, employed on several of the roads in that table.

Fig. 217A is the least elaborate, consisting of a single board bolted to the rail and raised a few inches above it. This method is employed on the Mersey Railway, where the live conductors are laid adjacent to one another between the two tracks. The wooden guard running the entire length of the line on each rail has been considered sufficient protection to those of the company's servants, who alone have access to the line.

In Fig. 217B two boards are used, one on each side of the rail. These afford better protection against anything falling across the line, and against the liability of any person coming in contact with the rail.

In Fig. 217C the two boards are tapered to more effectively cover in the rail.

In Fig. 217D an approach is made to covering in the rail with a horizontal board, leaving for the collecting shoe a small space between the upper face of the rail and the guard board. This necessitates an especially thin projecting shoe.

In the sketch shown, the cover board is supported by a timber beam on edge,

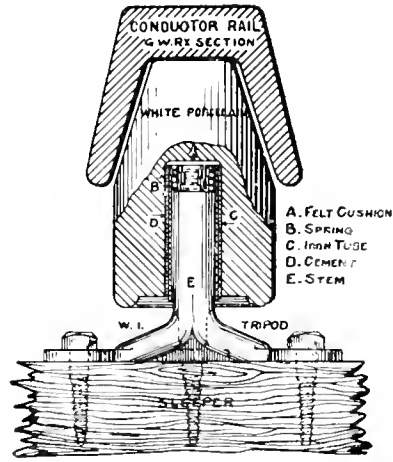

Fig. 216. 'CHAMBERS' PATENT
3RD RAIL INSULATOR.

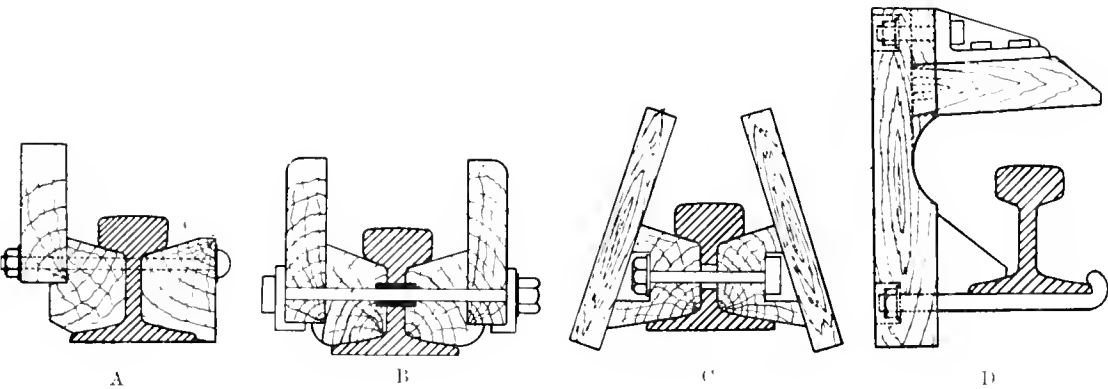

Fig. 217. METHODS OF PROTECTING CONDUCTOR RAILS.

running beside the rail and bolted thereto. This method is in use on the Paris-Orleans line, the New York Subway, and the Wilkesbarre and Hazelton Railroad in Pennsylvania. The General Electric Co. of America have used a similar guard board, supported on light iron brackets bolted on to the track sleepers.

The latest development in the direction of completely shielding the conductor rail

ELECTRIC RAILWAY ENGINEERING

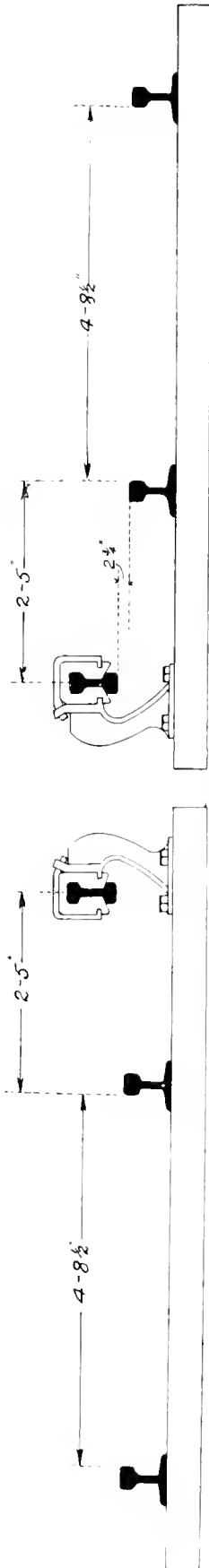

Fig. 218. N.Y.C. SHOWING ARRANGEMENT OF "UNDER-CONTACT" THIRD RAIL.

is the "under-contact" method of mounting introduced on the lines of the New York Central Railroad Co. Fig. 218 illustrates the "under-contact" type of rail mounting which is being tried on the New York Central Railway. The third rail is supported every 11 ft. by iron brackets, which hold the insulation blocks by a special clamp. The blocks, which are in two pieces, are 6 ins. long, and are designed so as to be interchangeable. Experiments are still being made with insulators of reconstructed granite, vitrified clay, rubber, and indurated fibre, to determine the relative advantages of these materials for the existing conditions. Between the supporting brackets the upper part of the rail is guarded by covering it with wooden sheathing, which is built up of three parts nailed together. A suitable shoe capable of making contact at its upper or lower face can be arranged to pass automatically from this rail to the ordinary top-contact rail in portions of the track where the latter occurs.

The advantages claimed for this type are (1) the thorough protection of the live rail: (2) less strain on the insulators, as the pressure from the shoe acts against instead of with gravity: (3) the board protection has a continuous support, and is therefore less liable to crack or warp; (4) the rail is more protected from the weather and hence less liable to corrode; (5) the contact surface is better protected from sleet or snow; (6) it is self-cleaning; and as there is much more space between the under-side of the rail and the earth, there will be less danger of accumulation of snow and ice and rubbish, and therefore less leakage.

The New York Central Railway third rail is not mounted rigidly in the insulators but is given a little play for expansion and contraction, except at certain central points where it is anchored. It weighs 70 lbs. per yard, is of special section and composition, and has a resistance between seven and eight times that of copper.

Another type of "under-contact" arrangement, exploited by the Farnham Co. of Chicago, is illustrated in Fig. 219.

Position of the Conductor Rails.

There appears to be but little uniformity in determining the position of the conductor rail with reference to the track rails, not only as to the distance between conductor rail and track rail, but also as to whether the conductor rail shall be between the track rails, in the 6-foot way, or outside the track on the off-side of the line.

THE DISTRIBUTING SYSTEM

and also as to whether the track sleepers shall carry the conductor rails. The late Mr. W. E. Langdon, in a paper read before the Engineering Conference in 1903,¹ considered that the conductor rails should be confined to the 6-foot way and dissociated entirely from the sleepers which carry the track rails. This view was based on the following considerations:—(1) The permanent way must be constantly patrolled; (2) packing and drainage of sleepers and renewals of broken chairs, sleepers, and rails, are constantly necessary, and must be provided for; (3) the off-side of the line is almost invariably used for laying out stores for works on the line, and by workmen when walking along the line. These considerations would apply more to main line railways than to interurban lines or tubes, and it is notable that the Metropolitan and District Railways of London have laid the positive rail on the off-side of the line outside the track, and the negative midway between the track rails. Both positive and negative rails are mounted on the track sleepers. The distance to be employed between the conductor rail and the track rails and the elevation of the former above the latter depend on the collecting arrangements on the trains, and on

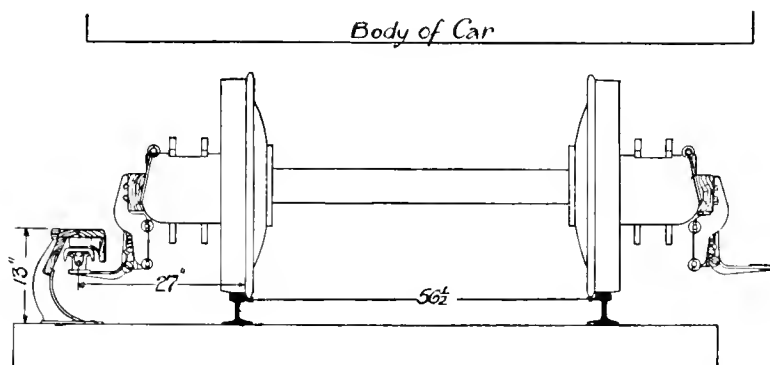

Fig. 219. THE FARNHAM "UNDER-CONTACT" PROTECTED THIRD RAIL SYSTEM.

the overall width of the rolling stock. In the case of roads carrying also steam traffic, the dimensions of the locomotives must be considered in this connection.

In Table LXXV., we have set forth these dimensions for a number of lines at present in operation. While the dimensions are usually of much the same general order, there is no evidence of adherence to any standard dimensions.

At the Engineering Conference in 1903, it was stated that the Clearing House Conference had decided in favour of a distance of 3 ft. 11½ ins. from centre of conductor rail to centre of track (*i.e.*, 29¼ ins. from centre of conductor rail to gauge line on nearest track rail), and that the top of the conductor rail should be 3 ins. higher than the top of the track rails. In America a move in the direction of standard dimensions has been made in the case of the electrification of the Long Island Railway,² where the same dimensions have been adopted as on the Pennsylvania Railway and the Interborough Rapid Transit Co.'s lines, namely 27 ins. from conductor rail centre to gauge line of track and 3½ ins. difference in height between top of conductor rail and top of track rails.

¹ See *Electrician*, Vol. LI., p. 447 (July 3rd, 1903).

² See *Street Railway Journal*, Vol. XXVI., p. 828 (Nov. 4th, 1905).

ELECTRIC RAILWAY ENGINEERING

TABLE LXXV.

Particulars of Conductor Rails for Various Railways.

Designating Number.	Railway.	Methods of mounting Conductor Rails (see Fig. 212).	Methods of protecting Conductor Rails (see Fig. 217).	Distance of Centre of Conductor Rail from Gauge Line of Nearest Track Rail, Inches.	Position of Conductor Rail: (a) outside Track Rail; (b) between Track Rail.	Height of Top of Conductor Rail above Top of Track Rail, Inches.
Main line railways:—						
1	Albany and Hudson Railway, New York	—	—	27	—	6
2	Baltimore and Ohio, new location	—	—	30	—	$3\frac{1}{2}$
3	“ “ “ old location	—	—	24	—	$1\frac{1}{2}$
4	Mersey Railway	—	—	22	—	$4\frac{1}{2}$
5	Milan Varese	A	D	26	a	$7\frac{1}{2}$
6	Neuchatel (Fribourg-Morat)	A	C	—	a	—
7	North-Eastern	A	B	$19\frac{1}{4}$	a	$3\frac{1}{4}$
8	New York, New Haven, and Hartford	—	—	$28\frac{1}{4}$	b	$1\frac{1}{2}$
9	Paris-Orleans	C	D	$25\frac{1}{2}$	a	$7\frac{1}{2}$
Interurban railways:						
10	Aurora, Elgin, and Chicago	—	—	$20\frac{1}{2}$	—	$6\frac{5}{8}$
11	Columbus, Buckeye Lake, and Newark	—	—	27	—	6
12	Columbus, London, and Springfield	—	—	27	—	6
13	General Electric Railway, Schenectady	—	—	28	—	3
14	Grand Haven, Grand Rapids, and Muskegon	—	—	$20\frac{3}{4}$	—	6
15	Lackawanna and Wyoming Valley	—	—	$20\frac{3}{4}$	—	6
16	New York Central	—	—	29	a	$2\frac{3}{4}$
17	Wilkesbarre and Hazleton Railway	A	D	28	a	5
Underground and elevated:—						
18	Baker Street and Waterloo	E	—	$16 (+ ve)$	a	3
19	Berlin Overhead and Underground	B	—	$28\frac{1}{4} (- ve)$	b	$1\frac{1}{2}$
20	Boston Elevated	—	—	$14\frac{3}{8}$	a	$7\frac{1}{8}$
21	Brooklyn Elevated	—	—	20 $\frac{1}{2}$	a	6
22	Central London	D	—	22	—	6
23	Great Northern and City	D	—	$28\frac{1}{4}$	b	$1\frac{1}{2}$
24	King's County Elevated Railway, New York	A	—	(+ ve)	a	—
25	Lake Street Elevated, Chicago	—	—	(- ve)	a	—
26	Liverpool Overhead Railway	—	—	$19\frac{1}{2}$	—	$5\frac{1}{4}$
27	Manhattan Elevated	—	—	$20\frac{1}{2}$	—	$6\frac{1}{2}$
28	Metropolitan District	A	B	$28\frac{1}{4}$	a	$1\frac{1}{2}$
29	Metropolitan West Side Elevated, Chicago	A	A and B	$16 (+ ve)$	a	3
30	North-Western Elevated Railway, Chicago	A	—	$28\frac{1}{4} (- ve)$	b	$1\frac{1}{2}$
31	Paris Metropolitan	C	—	$20\frac{1}{2}$	a	$6\frac{1}{4}$
32	Rapid Transit Subway, New York	C	—	$20\frac{1}{2}$	a	$6\frac{1}{4}$
33	South Side Elevated, Chicago	A	—	$13\frac{1}{2}$	a	$11\frac{1}{2}$
34	Waterloo and City	—	—	22	a	$4\frac{1}{2}$
35	Waterloo and City	—	—	$20\frac{1}{2}$	a	$6\frac{1}{2}$
36	Waterloo and City	—	—	$28\frac{1}{4}$	a	same level

From Table LXXV. we see that several American roads have used $20\frac{1}{2}$ ins. and $6\frac{1}{2}$ ins. for these dimensions. While there have, in various quarters, appeared sporadic attempts to standardise the position of the conductor rail, there appears to be no general and concerted effort for standardisation. We have given data for as many lines as possible, and would not at present lay down any one set of recommendations to be followed. It might be convenient to adopt the distance of $28\frac{1}{4}$ ins. between centre of third rail and gauge line which has been employed by the Underground

1 North Eastern Railway



2 Midland Railway

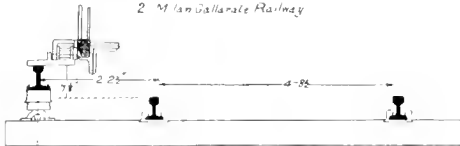

3 Wilkesbarre & Hazleton Railway

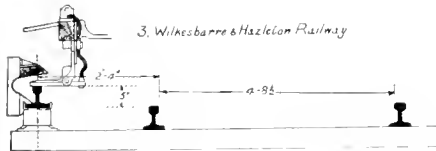

4 Metropolitan & District Railway



5 Manhattan Elevated Railway

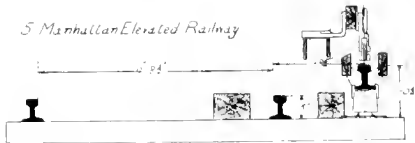

6 Paris-Orleans Railway



7 Central London Railway

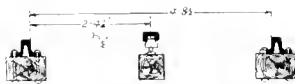

8 New York New Haven & Hudson River Railway

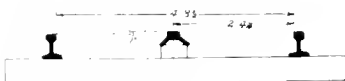

9 Baker St & Waterloo Railway



Fig. 220 SECTIONS OF SINGLE TRACK ON VARIOUS RAILWAYS.

THE DISTRIBUTING SYSTEM

10.A Berlin Elevated & Underground Railway - Section of Elevated Track

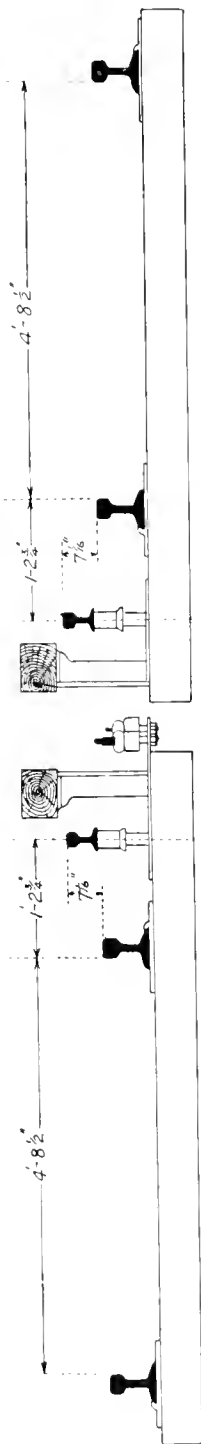
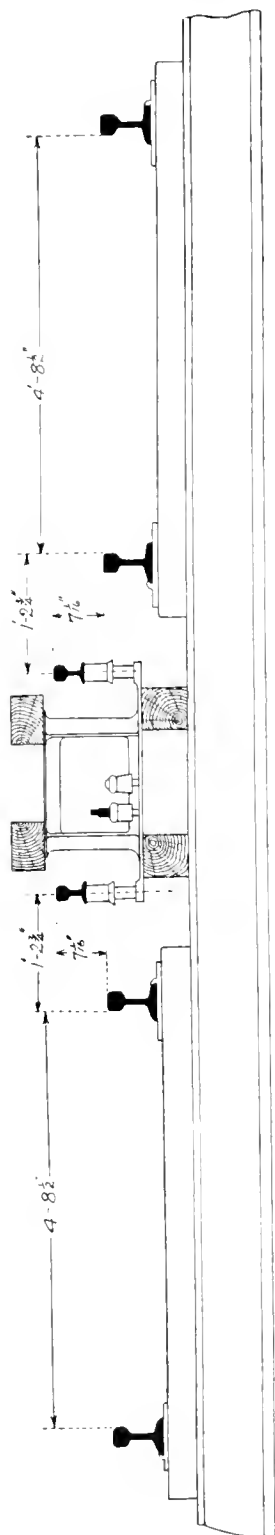

12. Baltimore-Ohio Railway. (New Location)

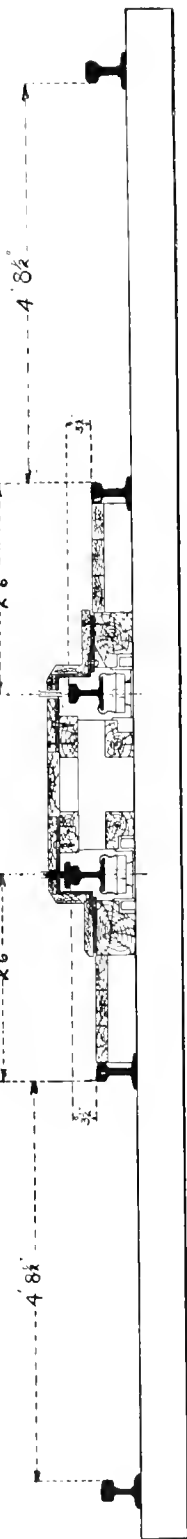

Fig. 221. SECTIONS OF DOUBLE TRACK ON VARIOUS RAILWAYS.

ELECTRIC RAILWAY ENGINEERING

Railways Co. of London, as this dimension bears some relation to the track gauge, being, in fact, exactly one half of the standard gauge of 4 ft. 8½ ins.

In Fig. 220 are shown sections through the conductor rails and track rails for single tracks, and in Fig. 221 for double tracks, of a number of typical railways, including most of the types of rail and of constructions which are as yet met with.

From these figures one may study the various methods of mounting track and conductor rails of various sections, and the relative position of the rails on these lines, and also in some cases the current collecting arrangements for rails protected in the various ways already enumerated.

In Table LXXIV. we have given for a number of railways, the leading particulars of the conductor rails. These comprise length per rail, weight per yard, area of

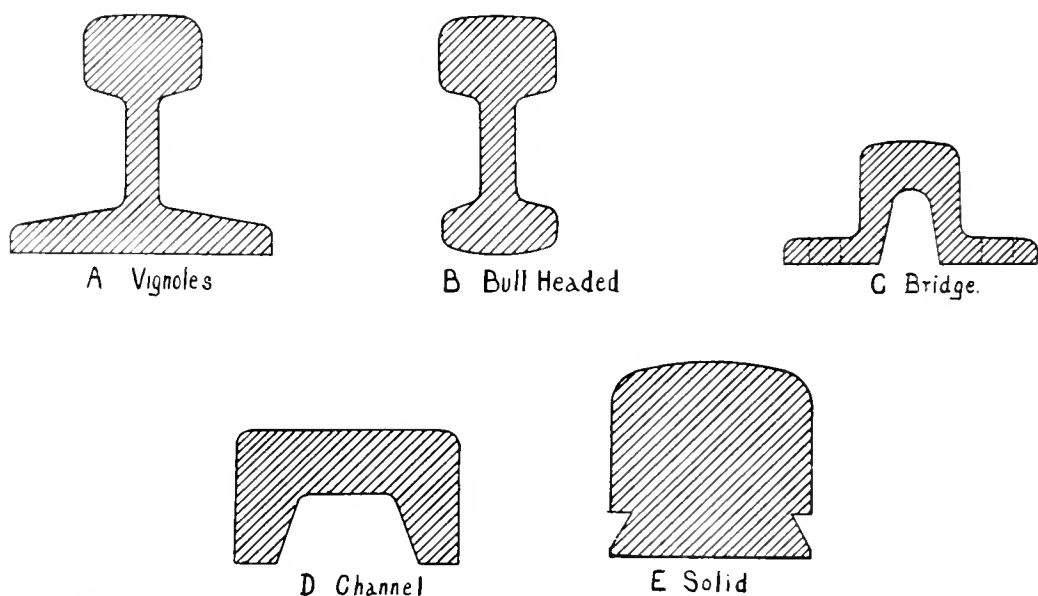

Fig. 222. SECTIONS OF VARIOUS TYPES OF CONDUCTOR AND TRACK RAILS IN COMMON USE.
(See reference letters in col. A, Tables 75, 103).

cross-section, and shape of rail section. For the latter item we show in Fig. 222 the sections of the various rails in common use, each section being designated with a letter, A, B, C, etc., corresponding with the letters in column 5 of Table LXXIV.

OVERHEAD SYSTEM.

In the overhead system the conductor is suspended above the track by attachment to one or two steel or bronze cables according to the distance between the supports and the nature of the train service. The method of suspending the conductor for railways, differs from that adopted for tramways. In the latter case the wire or conductor is attached to ears fixed to brackets or span wires 100 to 120 ft. apart; this method is quite unsuitable for railways owing to the higher speed and voltage commonly employed. Height and alignment should be maintained as uniformly as possible, so as to prevent shocks to the collector and suspensions, and to avoid

THE DISTRIBUTING SYSTEM

swaying. Further, it is necessary to secure the conductor so as to obviate the risk of breakdown, and to secure immunity from contact between conductors and vehicles should a conductor break. All these objects are secured by supporting the conductor at frequent intervals from steel or bronze cables suspended over the track, thus relieving the conductor of mechanical stresses.

The suspension cables may be supported from bracket arms attached to side poles in the case of a single line, or may be supported from a gantry spanning the tracks where two or more tracks are used.

Where side poles are used, the distance between poles on straight lengths of track should not exceed 120 ft., and in the case of gantries the distance may be from 120 to 300 ft., according to the height and strength of the gantry structure. On curves of less than 15 chains radius, intermediate poles are necessary for pull-off purposes.

The supports for carrying the brackets or gantries must be erected so that there shall be a minimum clearance of 2 ft. 4 ins. between the structure and the railway carriage, in accordance with the Board of Trade rules.

The suspension cables should be stranded, and may be of galvanised steel or silicon bronze.

For spans up to 180 ft. a single suspension cable may be used; a steel cable made up of 19 strands of No. 12 S.W.G., and having an ultimate tensile strength of 96,500 lbs. per square inch, will be found suitable. In order to minimize the swaying of the suspension cable due to wind pressure, the conductor should be stayed at the main supports.

For spans exceeding 180 ft. in length, a double cable suspension is recommended by some, in order to provide against lateral movement or swaying. This object is attained by spreading the cables apart from the middle of the span to the supports, so that the cables are curved in plan as well as in elevation; in other words, the cables instead of hanging in a vertical plane, are set in an inclined plane passing through the points of support and the conductor hangers; this form of suspension is very unyielding as regards lateral movement, but yields slightly to an upward pressure and relieves the collector of any shocks. A suitable size and quality of cable for double suspension, consists of 7 galvanised steel wires, each No. 10 S.W.G., the material having an ultimate tensile strength of 96,500 lbs. per sq. in.

For single cable suspension, the conductor may be suspended by hangers consisting of a single wire of galvanised steel of No. 8 S.W.G., one end being fixed to a clamp on the cable and the other to a mechanical ear which grips the conductor.

Where double cable suspension is used, the conductor is attached to the two cables by rods which may be made adjustable to suit any position in the span, or they may be made in fixed lengths, the number of different lengths depending upon the number of suspensions in the span. The simplest form of suspension consists of a stranded steel wire, the two ends of which are twisted around the suspension cables, the wire being passed through an eye in the ear or conductor grip. A suitable size of suspension consists of seven strands of No. 14 S.W.G. galvanised steel wire. Where attached to the cable, the core is cut away and the two sets of three strands are twisted around the cable in opposite directions. The two suspension cables may or may not be tied together, and either a rod or a stranded wire may be used for the purpose.

In erecting the overhead structure, the cables should be set so that the conductor suspended from them is approximately level for mean temperature conditions which may be taken at 50 degrees F. in this country. Table LXXVI. gives the dips at different temperatures and for spans varying between 120 ft. and 180 ft. for a

ELECTRIC RAILWAY ENGINEERING

single 19/12 steel cable carrying No. 4/0 hard drawn copper conductor, and also the dips for a span of 300 ft. for two steel cables, each cable being made up of seven No. 10 S.W.G. wires and supporting a No. 4/0 hard drawn copper wire. In each case the ultimate strength is taken at 96,500 lbs., and the factor of safety at 4 with wind pressure of 30 lbs. per sq. ft. The suspension cables being metallically connected to the conductor, are in consequence charged to the same potential, and must therefore be insulated from the supports: various forms of insulators are used by different companies, some of which will be illustrated later. The suspension cables should be clamped down to the insulators.

TABLE LXXVI.

Table of Span and Dip of Suspension Cables.

Breaking stress = 96,500 lbs. per sq. in. = 43 tons per sq. in.

Modulus of E. = 30,000,000.

Coeff. of expansion = 0.00000683 per degree F.

Factor of safety at 10 degrees F. wind pressure 30 lbs. per sq. ft. = 4.

Conductor = 4/0 S.W.G. copper.

Sag in feet for various spans and temperatures.

Single suspension of 19/12 S.W.G. steel wire cable.

Weight of span, including suspension cable, hangers and conductor = 1.2 lbs. per foot.

Span in feet.	10	20	30	40	50	60	70	80	90	100	F.
120	0.86	0.94	1.03	1.12	1.22	1.31	1.40	1.49	1.58	1.67	
130	1.01	1.10	1.20	1.29	1.38	1.48	1.58	1.67	1.77	1.87	
140	1.17	1.27	1.37	1.47	1.57	1.67	1.78	1.88	1.98	2.08	
150	1.35	1.46	1.56	1.67	1.77	1.87	1.98	2.09	2.20	2.30	
160	1.53	1.65	1.76	1.87	1.98	2.09	2.20	2.31	2.42	2.53	
170	1.73	1.85	1.97	2.08	2.20	2.31	2.43	2.55	2.67	2.78	
180	1.94	2.07	2.19	2.31	2.43	2.55	2.69	2.81	2.93	3.06	

Double suspension of 7/10 s.w.g. steel wire cable.

Weight of suspension cables, hangers and conductor = 1.5 lbs. per foot.

300	5.7	5.83	5.95	6.08	6.21	6.33	6.44	6.56	6.68	6.8
-----	-----	------	------	------	------	------	------	------	------	-----

The conductor is, as a rule, made of copper and grooved, and the usual size is No. 3/0 or No. 4/0 B. & S.; it should be suspended at a height of from 19 ft. to 21 ft. above the rails wherever permissible. The conductor is attached to the suspension cables by the hangers, at intervals of 10 ft.; where bow collectors are used the conductor should be set with a total stagger of 17 ins., that is, 8½ ins. on each side of the centre.

On curves of more than 30 chains radius, and with an allowable deviation from the central position of 1 ft., no special appliances are necessary: on curves between 15 and 30 chains the conductor may be pulled off from the gantries or side

THE DISTRIBUTING SYSTEM

poles, whilst on curves of less than 15 chains radius, pull-offs must be made to special poles provided for that purpose.

With regard to turnouts and crossways the angles are usually so small that special frogs are not necessary; the frog ear is arranged so that one trolley wire passes immediately over the other at the crossing, and the two are brought to the same level within a few feet of the crossing, the length of bow being sufficient to bridge the two wires before the difference in level affects the contact. In addition to the section insulators provided for separating the portions of the conductor fed by different feeders, section insulators should be fixed at crossover roads for keeping the overhead system of the two tracks entirely separate from one another.

The overhead work at bridges and tunnels will vary with the type and clearance.

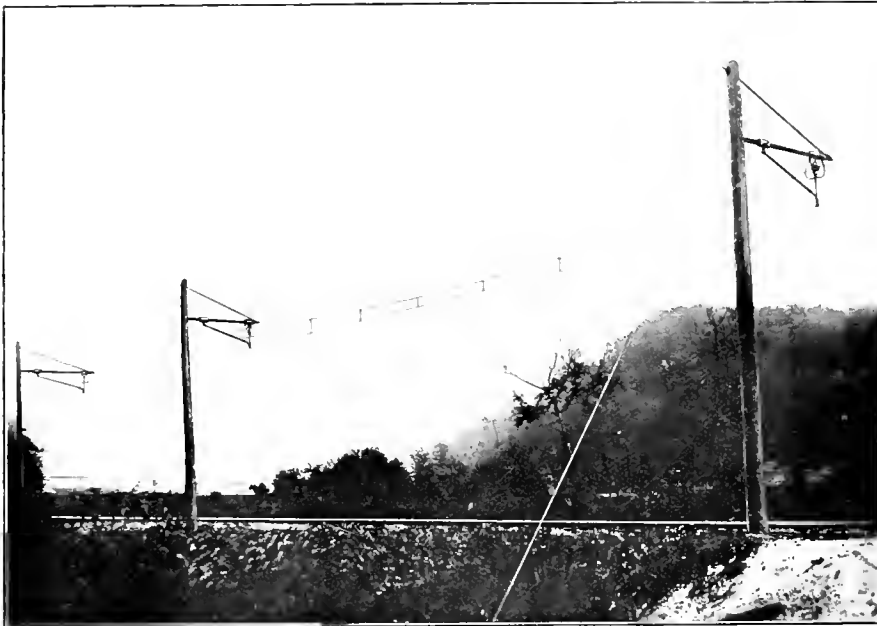

Fig. 223. PHOTOGRAPH SHOWING SINGLE CABLE SUSPENSION WITH SIDE POLES AS ERECTED BY THE WESTINGHOUSE COMPANY.

At high bridges it may be possible to carry the overhead wires through without special work. Where the clearance is small, it will be necessary to support the conductor from insulators attached directly to the structure.

Where, however, the clearance is so small as not to admit of this arrangement with any degree of safety, the conductors should be spread out of reach of the bow, and additional dead wires fixed to provide a running surface for the bow, section insulators being provided at the necessary distance apart on each side of the bridge so that the portion under the bridge cannot, under any circumstances, be made alive. This arrangement is not suitable for tunnels where a continuous live conductor must be provided; in this case the conductor must be fixed near the ground at the side of or between the rails, and the current collected by shoes attached to the cars; for the safety of the men working on the line, this arrangement will necessitate a reduction

ELECTRIC RAILWAY ENGINEERING

of the voltage of supply from that given by the overhead conductors to that needed directly at the motor terminals, the car transformer being cut out of circuit whilst running over this section.

We now submit illustrations of finished structures and also details of parts of the overhead structure.

A photograph of a side pole construction with single cable suspension is shown in

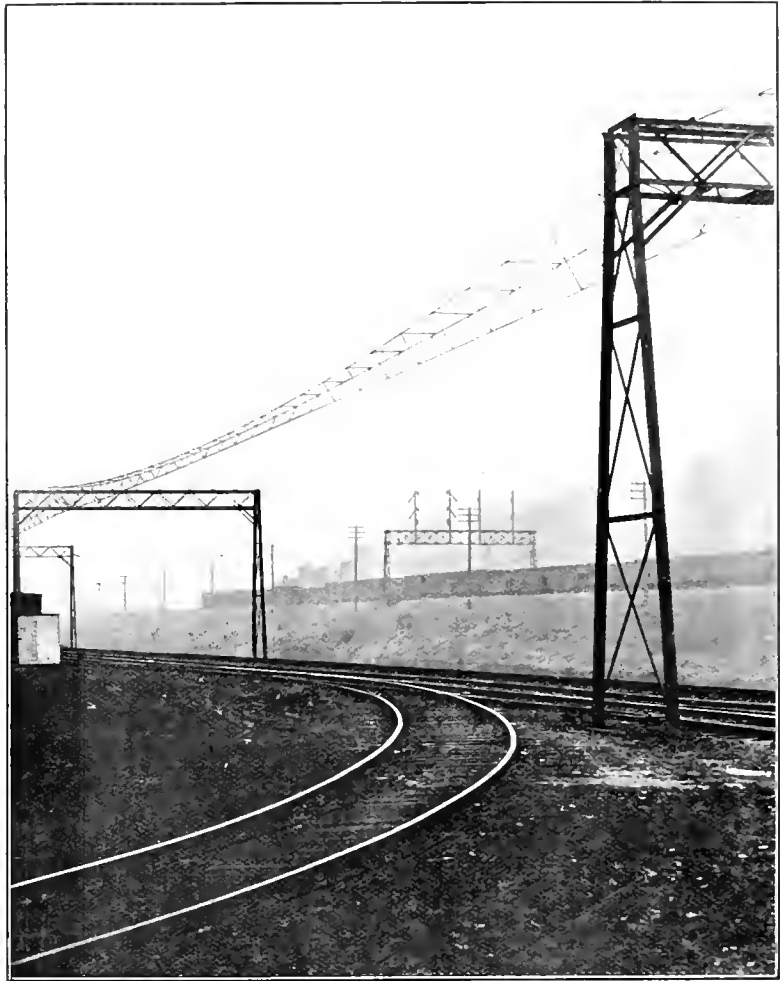

Fig. 224. PHOTOGRAPH SHOWING DOUBLE CABLE SUSPENSION SUPPORTED FROM GANTRIES CONSTRUCTED BY THE WESTINGHOUSE COMPANY.

Fig. 223, and a photograph of a double suspension with gantry supports is shown in Fig. 224.

As regards the details of construction of overhead conductor and supports, Fig. 225 shows a side pole and bracket for single cable suspension and single insulation, consisting of a latticed post with angle iron bracket arm carrying a porcelain insulator to which the suspension cable is clipped: the conductor is stayed from the post by means of a specially prepared rod of hickory.

THE DISTRIBUTING SYSTEM

Fig. 226 shows a side pole and bracket for single cable suspension, but with double insulation with special form of anchorage designed to yield slightly in a vertical direction, so as to prevent shock as the collector passes, and at the same time

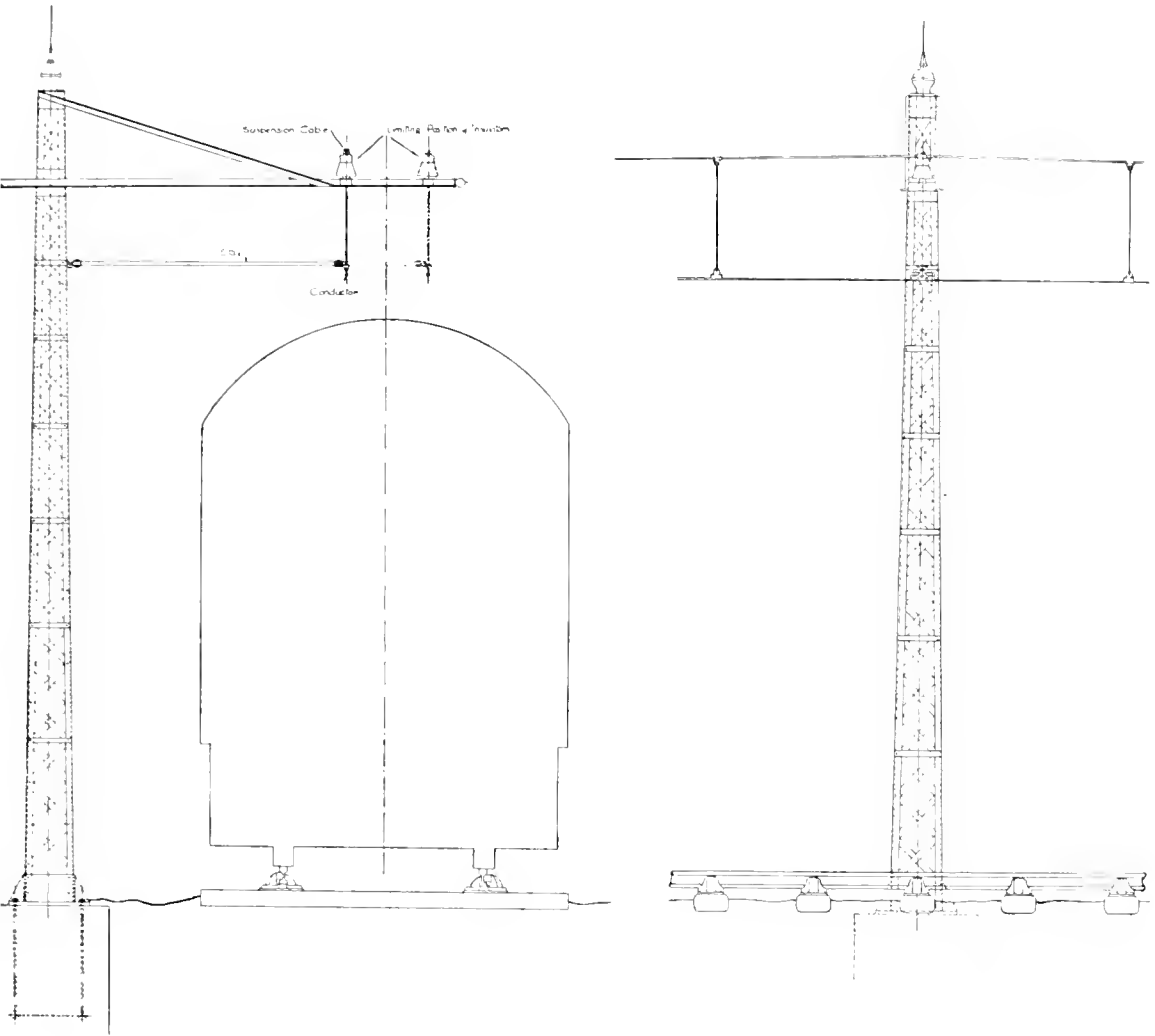

Fig. 225. SIDE POLE SINGLE INSULATION, SINGLE CABLE SUSPENSION. (BRITISH THOMSON-HOUSTON Co.)

to effectively prevent swaying in a lateral direction ; these methods are used by the British Thomson Houston Co.

Fig. 227 shows the method adopted by the Westinghouse Co. for suspending and staying the conductor for single suspension, single insulation with side poles. The insulator, Fig. 228, consists of a corrugated porcelain cylinder about 6 ins. long, 6 ins. diameter, with a 3 in. hole and a groove about half-inch deep about its centre. This porcelain is cemented on a malleable iron sleeve fitted with clamps,

ELECTRIC RAILWAY ENGINEERING

by means of which it is secured to the bracket arm. The clamps of the mounting sleeve are provided with lugs into which loops are inserted for the purpose of

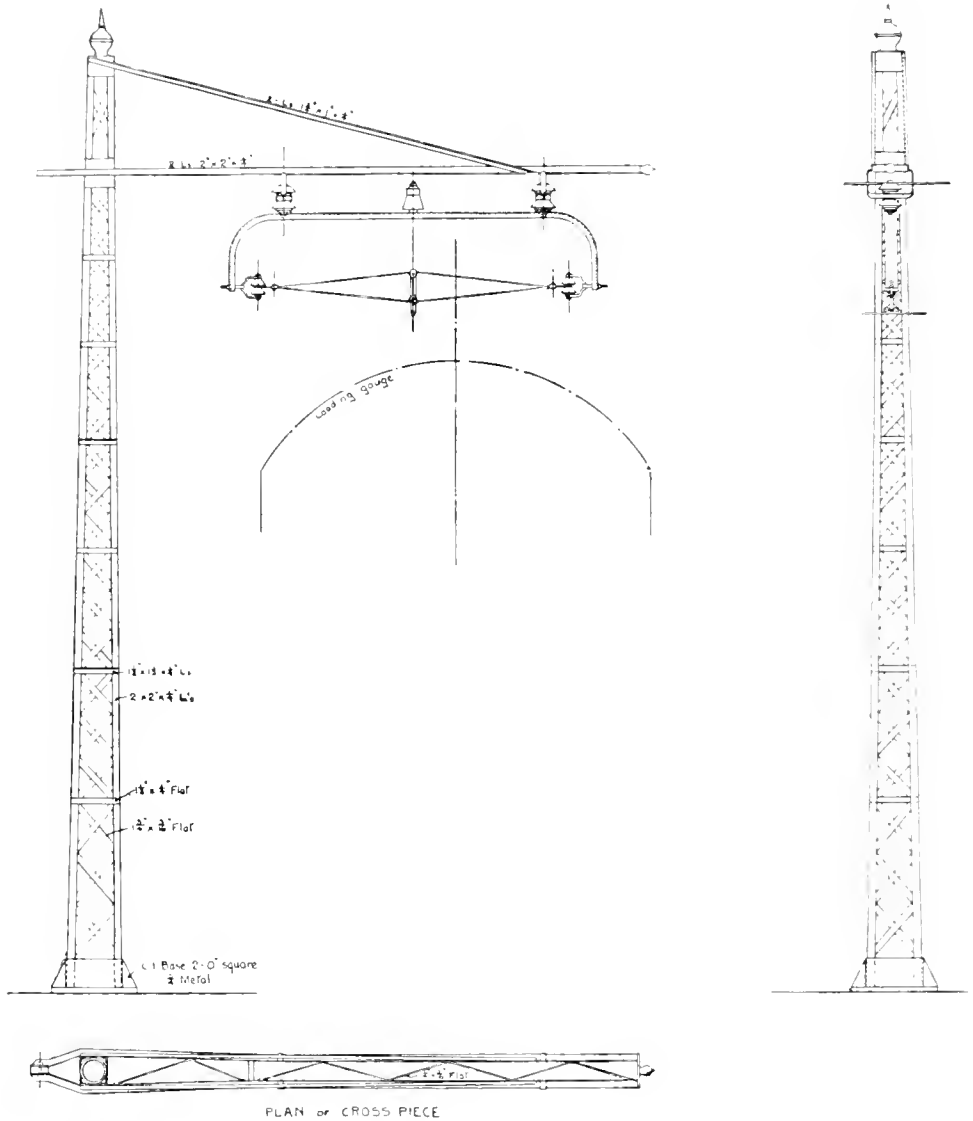

Fig. 226. SIDE POLE DOUBLE INSULATION SINGLE CABLE SUSPENSION WITH VERTICALLY YIELDING ANCHORAGE. (BRITISH THOMSON-HOUSTON Co.)

protecting the porcelain against accidental breakage by reason of a trolley flying off the wire and striking the porcelain.

Fig. 229 shows the stay used to prevent the conductor from swaying.

Fig. 230 shows a section insulator; as the suspension cable and the conductor are electrically connected it is necessary to break the circuit on both. The ends of the suspension cable are fastened to separate line insulators which are suspended from

THE DISTRIBUTING SYSTEM

the bracket arms, and the continuity of the conductor is broken and the space filled by a piece of specially treated hickory.

Fig. 231 shows another method of sectionalising the conductor: the ends of the

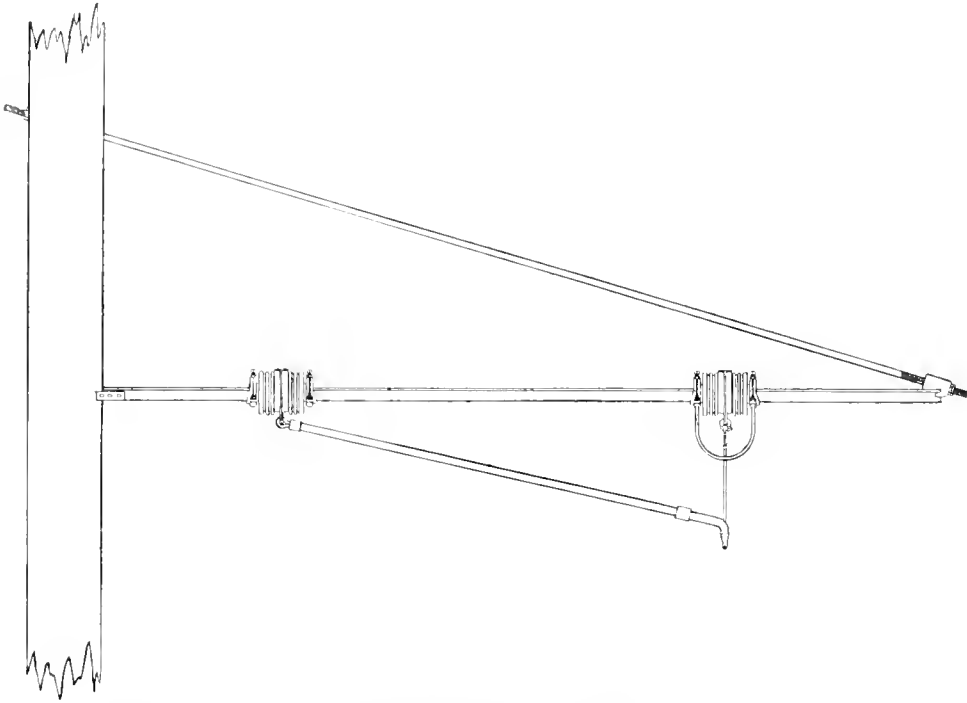

Fig. 227. SIDE POLE AND BRACKET ARM, WITH INSULATORS AND STAY.
(BRITISH WESTINGHOUSE Co.)

two sections, instead of being continued in a straight line, run parallel for a short distance, the bow being long enough to bridge the space between them; oil break switches are also shown for connecting up the sections, and an air break switch for connecting the conductors over the separate lines of track.

Fig. 232 illustrates the hanger for suspending the conductor from the cable; the upper end of the hanger is clamped to the cable and the lower end carries a vice which grips the conductor, the latter being grooved to afford a hold for the clips.

Fig. 233 shows a curve pull off; on sharp curves these must

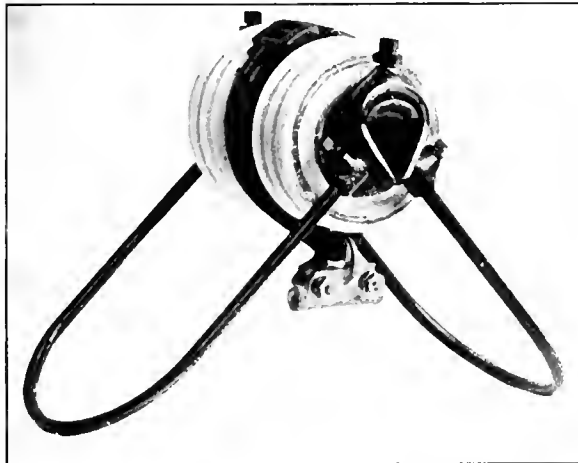

Fig. 228.—BRACKET ARM INSULATOR. (BRITISH WESTINGHOUSE Co.)

ELECTRIC RAILWAY ENGINEERING

be provided in order to maintain the position of the conductor relative to the track, within the prescribed limits.

For two or more tracks, it is necessary to employ a gantry spanning the tracks for supporting the overhead lines; these may be of light design where they are spaced from 150 to 180 ft. apart, in which case a single cable suspension is used. Fig. 234

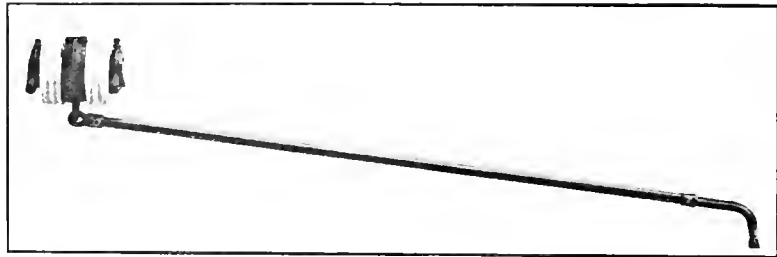

Fig. 229. INSULATED STAY FOR TROLLEY WIRE FOR ATTACHING TO BRACKET ARM. (BRITISH WESTINGHOUSE Co.)

shows a gantry for two tracks, supporting two conductors on the single cable principle with double insulation. In many cases it is found cheaper to increase the length of span and diminish the number of supports; in this case the gantry supports are stiffer and higher, and it becomes necessary to employ a double cable suspension to prevent lateral movement of the conductor.

A general view of this kind of structure is shown in Fig. 235. The span

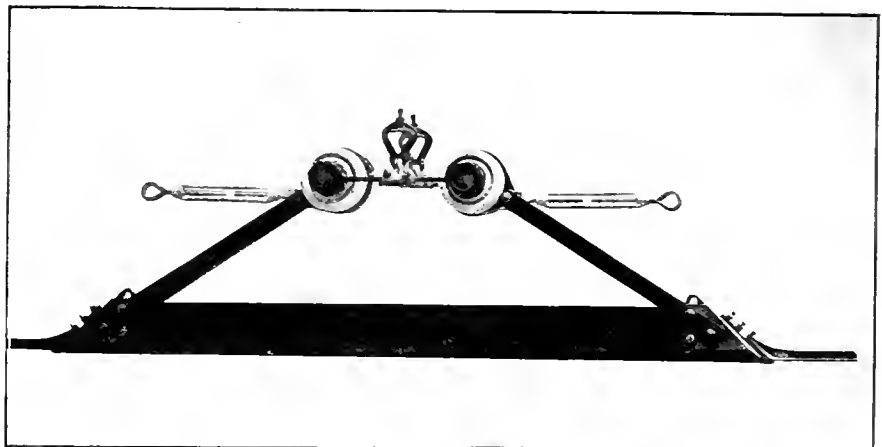

Fig. 230. SECTION INSULATOR. (BRITISH WESTINGHOUSE Co.)

is 300 ft. Fig. 235 shows gantry constructions for two, four and six tracks with double cable suspension. The two supporting cables and the conductor are tied together, the ties forming three sides of a triangle; the cables are set in a plane passing through the points of suspension and the attachment to the conductor. this forming a very rigid arrangement: the triangles formed by the tie rods remain

THE DISTRIBUTING SYSTEM

similar, but vary in size according to their position in the span. The ties can be made in sets and non-adjustable, or in single adjustable pattern.

TRACK RAILS.

The track rails are frequently used as a return conductor, and it is important, therefore, to know the properties of track rails as conductors of electricity and the methods adopted for securing electrical continuity.

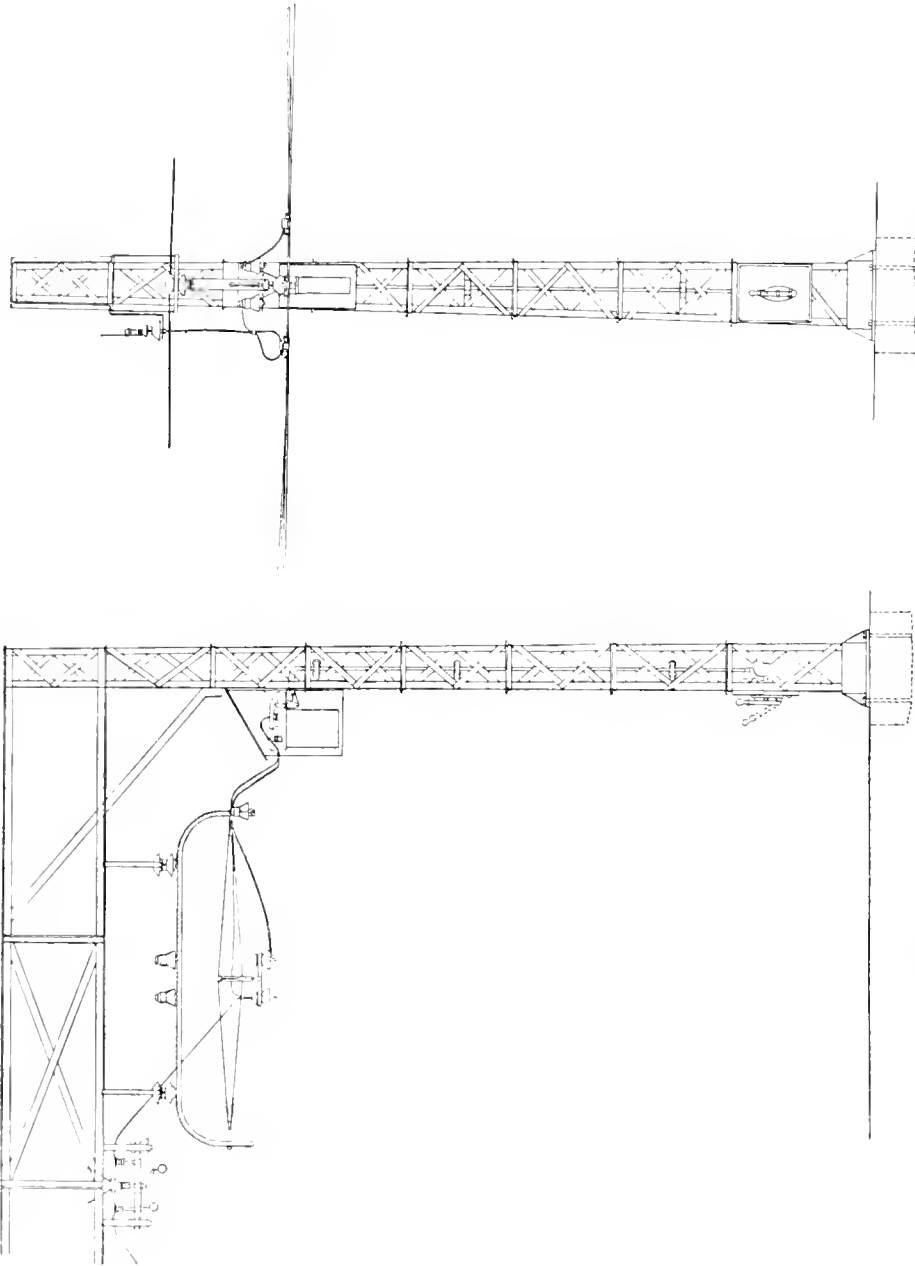

Fig. 231. METHOD OF SECTIONALISING CONDUCTOR. (BRITISH THOMSON-HOUSTON CO.)

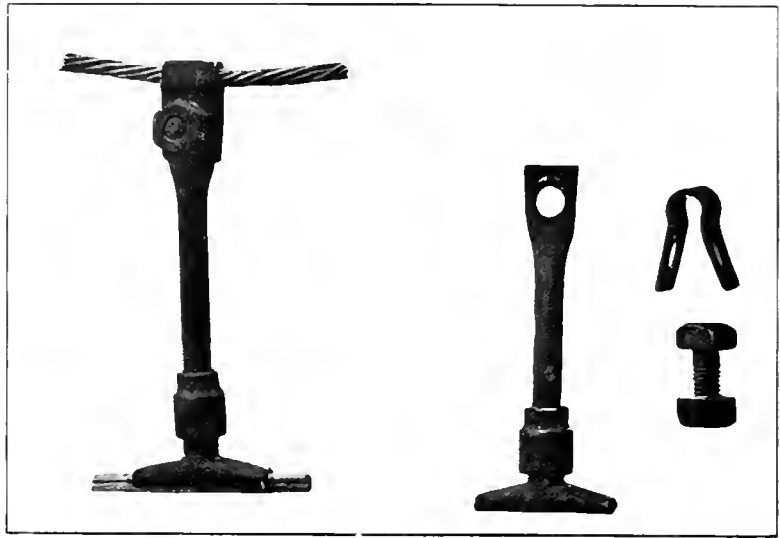

Fig. 232. HANGER OF SUSPENDER. (BRITISH WESTINGHOUSE Co.)

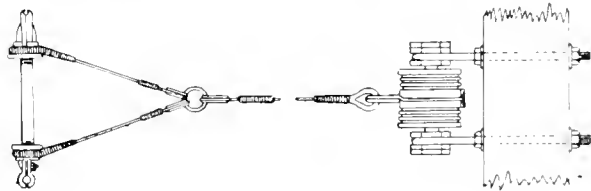

Fig. 233. CURVE PULL-OFF. (BRITISH WESTINGHOUSE Co.)

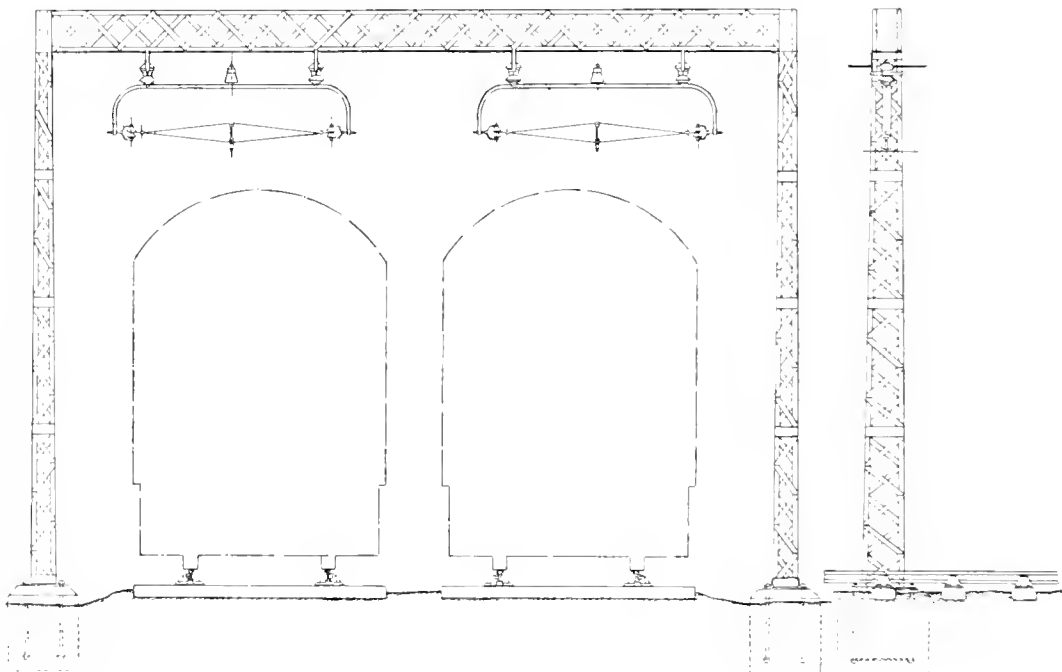
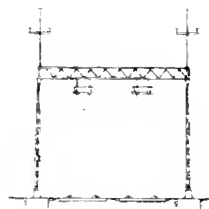
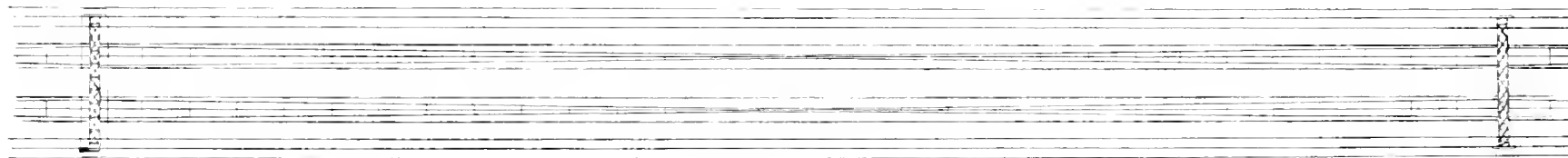
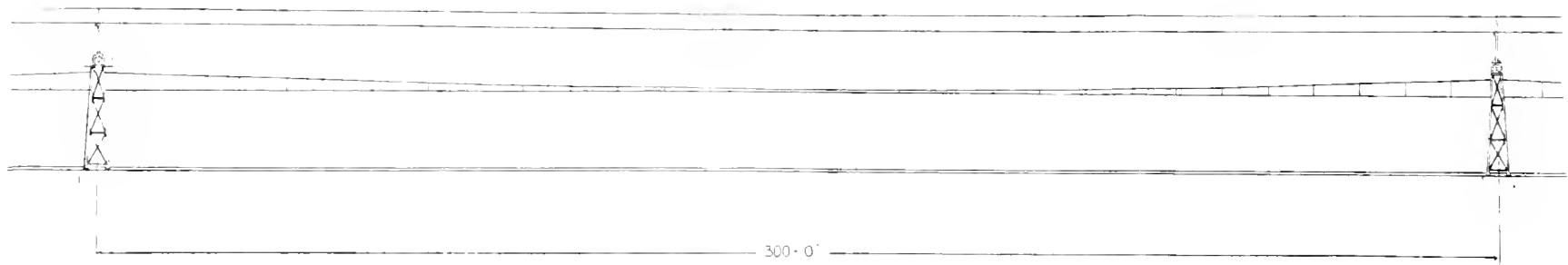
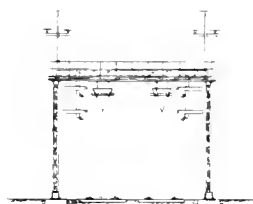

Fig. 234. GANTRY FOR TWO TRACKS, SUPPORTING TWO CONDUCTORS ON THE SINGLE CABLE PRINCIPLE WITH DOUBLE INSULATION. (BRITISH THOMSON-HOUSTON Co.)



TWO TRACK BRIDGE
WITHOUT SIGNALS



TWO TRACK BRIDGE
WITH SIGNALS

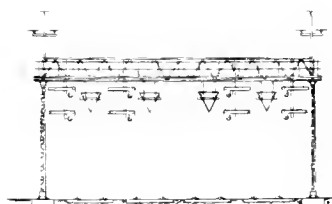

FOUR TRACK BRIDGE WITH SIGNALS

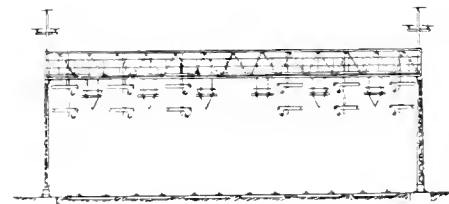

SIX TRACK BRIDGE WITH SIGNALS

Fig. 235. GANTRY CONSTRUCTIONS FOR TWO, FOUR, AND SIX TRACKS, WITH DOUBLE CABLE SUSPENSION.



THE DISTRIBUTING SYSTEM

Were the electrical standpoint alone considered, the material of the track rails should be chosen with reference to its specific conductivity. This is, of course, impracticable, as a minimum of wear is a matter of prime importance.

The most extensively employed material for track rails is hard steel, but practice as regards the composition of rails has varied considerably in the past, and even now one finds wide variations in the practice of different railroads and of different countries. It may be said that English rails some years back commonly conformed to the following analysis:—

Carbon	0.25 to 0.35
Manganese	0.8 to 1.0
Silicon	0.05
Phosphorus	0.06
Sulphur	0.06

Of late years the percentage of carbon has increased. One large railway company specifies—

Carbon	0.4 to 0.5
Manganese	0.85 to 0.95
Silicon	0.06 to 0.10
Phosphorus	0.08 to 0.1
Sulphur	0.08

In American practice, the carbon runs still higher, and may be fairly represented by the following analysis:—

Carbon	0.45 to 0.55
Manganese	0.8 to 1.0
Silicon	0.1 to 0.15
Phosphorus	0.06
Sulphur	0.06

A report recently issued by the American Society of Civil Engineers, drawn up after the investigation of manufacture and chemical composition of rails, recommends the following specifications:—

Bessemer Steel Rails.

Composition.	70 to 79 lbs. Per cent.	80 to 89 lbs. Per cent.	90 to 100 lbs. Per cent.
Carbon	0.50 to 0.60	0.53 to 0.63	0.55 to 0.65
Phosphorus, not exceeding	0.085	0.085	0.085
Silicon	0.20	0.20	0.20
Sulphur	0.075	0.075	0.075
Manganese	0.75 to 1.00	0.80 to 1.05	0.80 to 1.05

Basic Open-hearth.

Composition.	70 to 79 lbs. Per cent.	80 to 89 lbs. Per cent.	90 to 100 lbs. Per cent.
Carbon	0.53 to 0.63	0.58 to 0.68	0.65 to 0.75
Phosphorus, not exceeding	0.05	0.05	0.05
Silicon	0.20	0.20	0.20
Sulphur	0.06	0.06	0.06
Manganese	0.75 to 1.00	0.80 to 1.05	0.80 to 1.05

ELECTRIC RAILWAY ENGINEERING

The manufacturers' standard specification for the acid Bessemer process has been as follows:—

Composition.	70 lbs. up to 80 lbs. Per cent.	80 lbs. up to 90 lbs. Per cent.	90 lbs. up to 100 lbs. Per cent.
Carbon	0·45 to 0·55	0·48 to 0·58	0·50 to 0·60
Phosphorus, not exceeding	0·10	0·10	0·10
Silicon	0·20	0·20	0·20
Manganese	0·75 to 1·00	0·80 to 1·10	0·80 to 1·10

In France, yet higher percentages of carbon have been employed, running up to nearly 1 per cent.

The bull-head rail has now been standardised in Great Britain by the Engineering

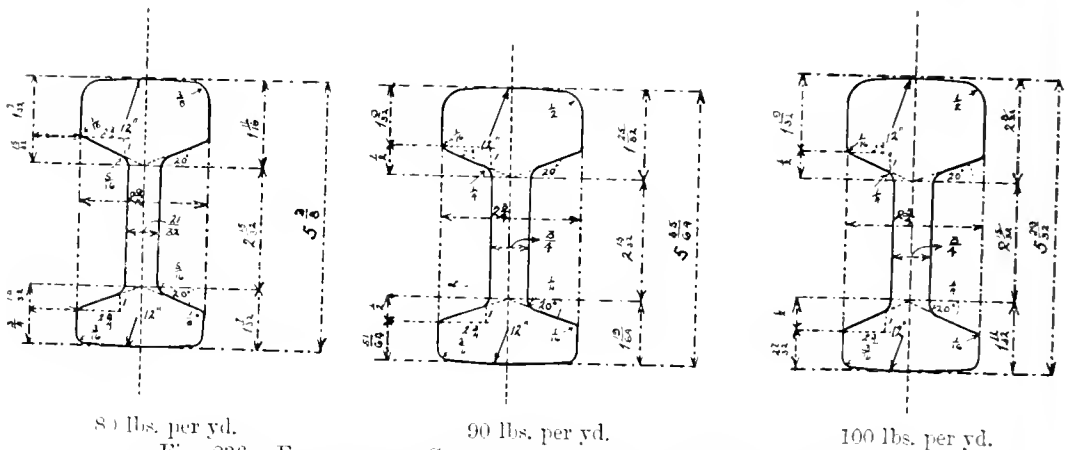

Fig. 236.—ENGINEERING STANDARDS. COMMITTEE STANDARD SECTIONS.

Standards Committee. Three standard sections, weighing respectively, 80, 90, and 100 lbs. per yard, are shown in Fig. 236.

Whether of Bessemer or Siemens-Martin steel, the chemical composition is specified as follows:—

Carbon	0·35 to 0·5 per cent.
Manganese	0·7 to 1·0 ..
Silicon not to exceed	0·1 ..
Phosphorus	0·075 ..
Sulphur	0·08 ..

The results, as far as regards the electrical resistance, are shown in the following table¹ of trials of sample sections of steel rail of varying composition, which were furnished for testing purposes:—

Carbon.	Manganese.	Silicon.	Phosphorus.	Sulphur.	Resistance in Ohms compared with Copper at 20° C.	Resistance in Ohms of 1 Mile, 1 Square Inch Section at 20° C.
0·378	0·550	0·181	0·040	0·041	10·8	0·468
0·446	0·568	0·188	0·046	0·044	11·1	0·482
0·536	0·592	0·201	0·051	0·059	11·3	0·490
0·568	0·608	0·204	0·053	0·061	11·4	0·495
0·588	0·632	0·214	0·056	0·065	11·5	0·499
0·610	0·650	0·220	0·062	0·071	12·9	0·560

¹ These results, as also certain others contained in this section, are taken from a paper entitled "Earth Returns for Electric Tramways," by H. F. Parshall,—"Journal of the Institution of Electrical Engineers," Vol. XXVII., p. 440.

THE DISTRIBUTING SYSTEM

Eight 76-lb. track rails, tested in place after two and a half years' use, gave the following results:—

Test Number.	Resistance compared with Copper at 20° C.	Resistance in Ohms, of 1 Mile of 1 Square Inch Sectional Area at 20° C.
1	11·3	0·490
2	10·3	0·447
3	10·1	0·438
4	10·7	0·464
5	9·65	0·419
6	10·07	0·437
7	10·25	0·445
8	10·50	0·455
Average .	10·4	·45

Two old 65-lb. rails, much worn, tested in places, gave the following results:—

Test Number.	Resistance compared with Copper at 20° C.	Resistance in Ohms of 1 Mile of 1 Square Inch Sectional Area at 20° C.
1	11·7	0·508
2	12·3	0·534
Average .	12·0	0·52

Higher values would be expected owing to the wearing of the rail, which is not allowed for in the calculations.

Two new 90-lb. rails, tested in place, gave the results following:—

Test Number.	Resistance compared with Copper at 20° C.	Resistance in Ohms of 1 Mile of 1 Square Inch Sectional Area at 20° C.
1	10·6	0·460
2	10·4	0·451
Average .	10·5	0·455

A 66½-lb. rail, not laid, gave results as follows:—

1	10·0	0·434
---	------	-------

Thus for practical purposes, we may estimate the resistance of track rails on the basis of a specific resistance equal to eleven times that of copper

In Table LXXVII, are given for the three standard rails of Fig. 236, the resistances in ohms per mile for single track and two-track roads, the resistance of the bonds being

ELECTRIC RAILWAY ENGINEERING

assumed as negligible. For types of bonding where this assumption should not hold, suitable correction factors are employed based on experience. A poorly bonded track may have a far higher resistance. The table also includes the tons per mile, and also the cost of the steel rails per mile of single and double track.

The figures given in Table LXXVII. are based on the assumption that the rail has 10.5 times the resistance of pure copper.

TABLE LXXVII.
Particulars of Standard Track Rails.

Weight of Rail in Pounds per Yard.	Single Track—Two Rails.			Double Track—Four Rails.	
	Weight of Rails in Tons per Mile of Track.	Resistance of Track in Ohms per Mile.	Cost of Track Rails in Pounds per Mile.	Weight of Rails in Tons per Mile of Track.	Resistance of Track in Ohms per Mile.
80	126	0.028	660	252	0.014
90	141	0.025	742	282	0.0125
100	157	0.0225	825	314	0.0112

Specific resistance of steel = 10.5 times that of pure copper.

In Table LXXVIII. are brought together a considerable number of particulars of the track rails of various electric railways.

TABLE LXXVIII.
Particulars of Track Rails of Various Railways.

	Railway.	Particulars of Track Rails.			
		Length in Feet.	Weight in Pounds per Yard.	Section. (See Fig. 222.)	Area in Square Inches.
1	Paris Metropolitan	50	100	A	9.8
2	New York Subway	33	100	A	9.8
3	Boston Elevated	60	85	—	8.36
4	Central London	60 (B) 60 (C)	100 (B) 100 (C)	B used for points C used in tunnels	9.8 9.8
5	Great Northern and City Railway	—	85	Flanged cross-section	8.36
6	Lancashire and Yorkshire Railway	—	70	B	6.9
7	Berlin Electric Overhead and Underground	39 ft. 4 ins.	52 86	A 52-lb. rails west side A 86-lb. rails east side	5.12 8.46
8	Berlin-Zossen	39 ft. 5 ins.	82	A	8.06
9	Valtellina	—	55 71	— —	5.41 7.0
10	City and South London	—	60 80	— —	5.9 7.87
11	Baker Street and Waterloo Railway	34 ft. 11 ins. 36 ft. 5 ins.	90 90	B B	8.85 8.85
12	Petaluma and Santa Rosa Rail- way, California	30	70	A American Society Civil Engineers' standard	6.9
13	Milan-Varese-Porto Ceresio Railway, Italy	—	72.6	A	7.15
14	St. Georges de Commaires la Mure, France	36	60	—	5.9

THE DISTRIBUTING SYSTEM

TABLE LXXVIII.—*continued.*

		Particulars of Track Rails.			
Railway	Length in Feet.	Weight in Pounds per Yard.	Section.	Area in Square Inches.	
15	Liverpool Overhead	—	56	A	5.51
16	Mersey Railway, Liverpool	36	86	B	8.46
17	Manx Electric Railway, Douglas, & Ramsey	—	56	A	5.51
18	Seattle-Tacoma	30	62.5	A	6.16
19	Jackson and Battle Creek Railway	30	70	A	6.9
20	Manhattan Elevated	—	—	—	—
21	Metropolitan District Railway	—	—	—	—
22	London, Brighton, and South Coast Railway	—	—	—	—
23	New York Central	—	—	—	—
24	Paris-Versailles	—	—	—	—
25	North-Eastern	—	—	—	—

Bonds.

By far the greater percentage of the bonds at present in use are of the so-called "pressure-contact" type, and consist in a heavy copper wire or cable, with drop-forged terminals. In some types of bond, cast copper terminals have been employed, but these have been most unsatisfactory. The resistance of cast copper is very much greater than that of drawn copper, so that it is not so much suited for bonds. Further, and most important, the union between cast copper and drawn copper wires is imperfect, so that the electrical resistance is much higher than that between two pieces of bare copper fused together.

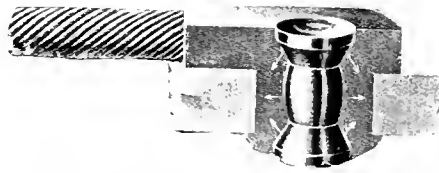

Fig. 237. GENERAL ELECTRIC Co. (U.S.A.)
RAIL BOND: SECTION THROUGH BOND,
SHOWING EFFECT OF COMPRESSION.

In the pressure-contact type of bond, the current density at the contact surface should preferably not exceed twenty-five amperes per square inch. The fact that higher current densities are used in the bulk of the work done, does not affect the desirability of adhering to the above rule.

In the pressure-contact type of bond, in spite of the greatest care in installing, there will always be some slight movement between the surface, due either to temperature changes or to vibration occurring during the passage of cars or trains, or to the combined effect of temperature changes and vibration. This leads ultimately to a loosening of the joint; a film of oxide forms, and the value of the contact is gradually destroyed.

The pressure-contact types of bond have been of two kinds. In the one the bond terminal was forced through an external cylindrical copper sleeve, but this type requires two contact surfaces between the rail and the bond. In an alternative type, a steel channel pin is driven through a hole in the head of the bond, forcing the copper bond into close contact with the metal rail.

ELECTRIC RAILWAY ENGINEERING

One such type of bond, made by the General Electric Co., U.S.A., is shown in Fig. 237, and the steel channel pin is shown at its centre, as already explained. In this type of bond, the conical ends of the steel channel pin are hardened, and the shank, which is soft at the centre, expands under the pressure which is applied at the two ends of the bond.

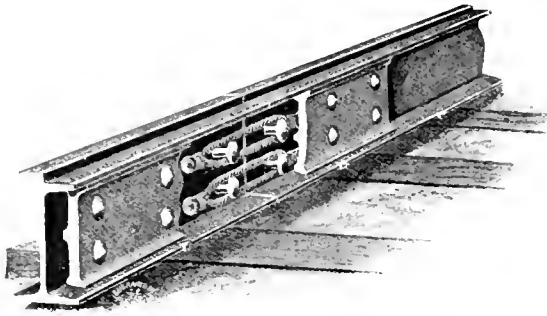

Fig. 238. GENERAL ELECTRIC Co. TYPE OF BOND, PROTECTED BY FISHPLATE.

Fig. 238 shows a bond of this type, arranged to be protected by the fish-plate. For this purpose it has a double cable for straddling the fish-plate bolts.

In Fig. 239 the bonds are located under the bottom flange of the rail. In

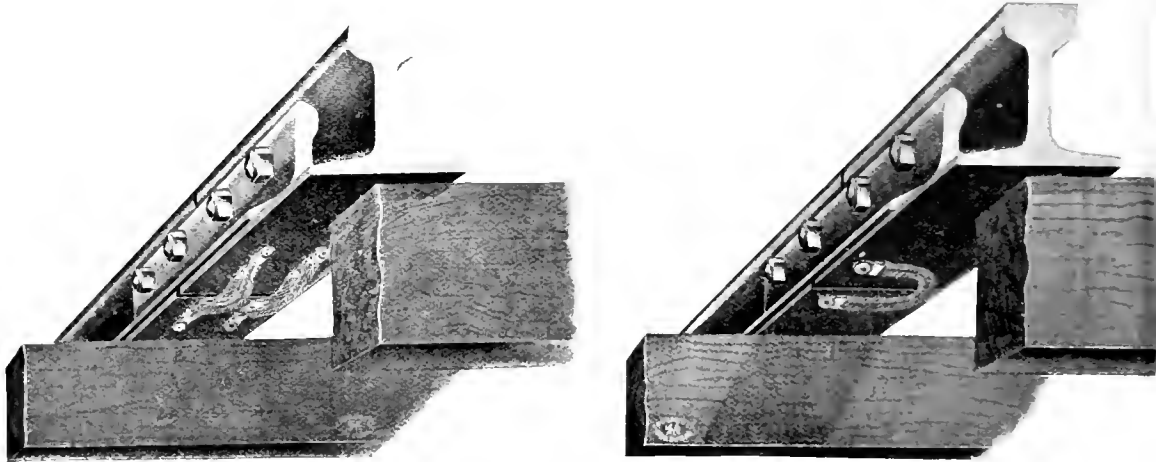

Fig. 239. GENERAL ELECTRIC Co. TYPE OF BOND UNDER SOLE OF RAIL.

Fig. 240 there is not room enough for the bonds under the fish-plate, and it becomes necessary to locate them outside of the fish-plate.

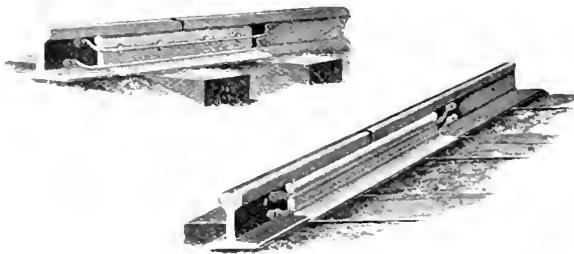

Fig. 240. GENERAL ELECTRIC Co. BOND OUTSIDE FISHPLATE.

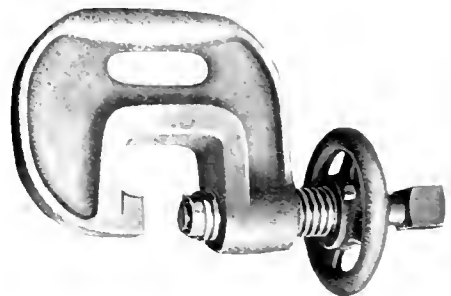

Fig. 241. RAIL BONDING PRESS.

ELECTRIC RAILWAY ENGINEERING

consists of copper strips or stranded copper, fused or welded on to solid cylindrical terminals, which are expanded into holes in the rail by a bond compressor.

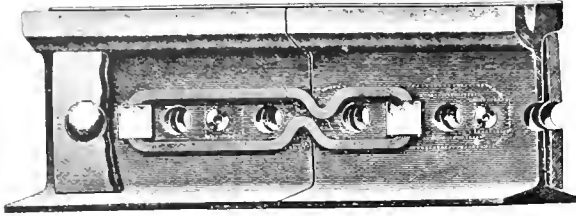
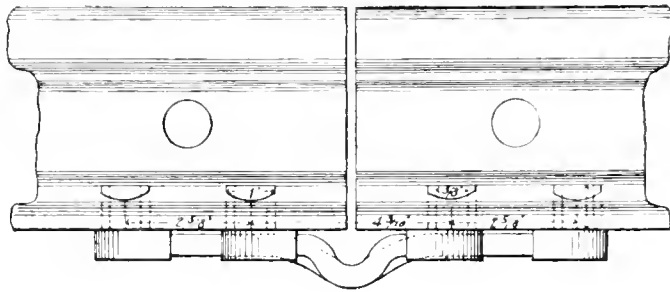

Fig. 243. PROTECTED TYPE RAIL BOND UNDER FISHPLATE.

Fig. 243 gives a view of this bond with fish-plate removed. The Forest City bonds are used on the Metropolitan District Railway Co.'s track. Figs. 244 and 245 show one of these quadruple bonds located beneath the sole of the rail.

Fig. 246 shows the Chicago Rail Bond, in which contact is made by pressure of a



Short Bond is 5 in.; Long Bond 10 3/4 inches between Terminal Centers

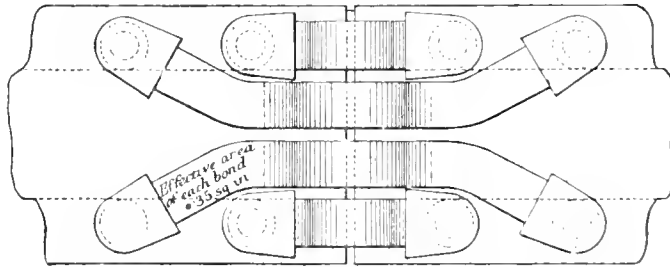

Fig. 244. PROTECTED TYPE OF BONDS ON LONDON UNDERGROUND ELECTRIC RAILWAYS.

copper cylinder against the sides of a hole in the rail by means of a steel pin driven

into the hole in the copper cylinder. This makes a solid contact between the iron and the copper, excluding moisture and air and minimising corrosion. With the original Chicago bond, as illustrated in Fig. 246, it was necessary for both sides of the rail to be exposed, as the pin was driven in from the reverse side of the rail to that on which the bond was placed. This led to the development of the Chicago Crown Bond, illustrated in Fig. 247, in which the copper terminal is made so that the securing pin is driven in from the same side of the rail as the bond. The connecting piece is either of solid or

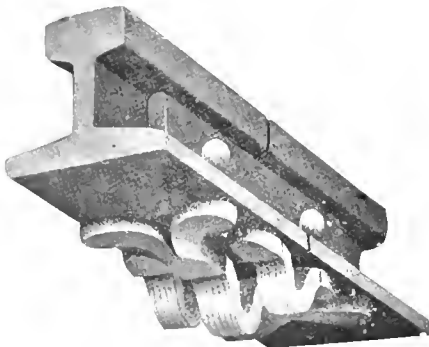

Fig. 245. PROTECTED TYPE OF BOND ON LONDON UNDERGROUND ELECTRIC RAILWAYS.

THE DISTRIBUTING SYSTEM

stranded copper, welded into the copper terminal cylinders, the stranded form allowing greater flexibility.

Crown bonds are employed on the Central London Railway and elsewhere.

The Neptune Bond has a steel cylindrical pin driven into a cylindrical hole in the copper terminal, which fits a hole in the web of the rail.

The Columbia Bond (Fig. 248) is another type where direct pressure between the copper terminal with the sides of a hole in the web of the rail, is used. In this case the bond end takes the form of a tapered cylinder on which is slipped from the other side of the rail, a tapered thimble. The copper terminal and thimble are expanded by a hand press to give a solid contact with the rail.

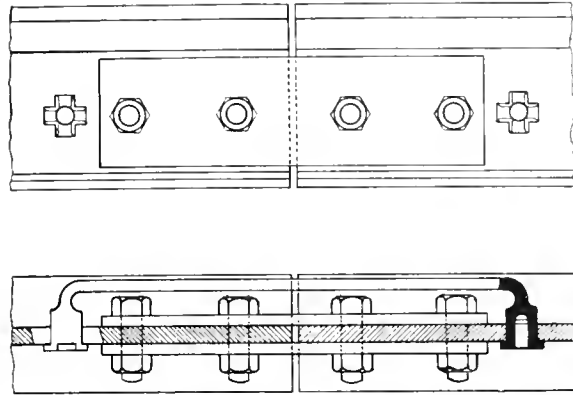

Fig. 246. CHICAGO RAIL BOND.

Amongst the various pressure-contact types of bond referred to above, there would not appear to be much to choose, and all are extensively used at the present time. The chief property is to get a solid, durable, and reliable contact between the rail and the bond, and generally wherever the bond is pressed and expanded into the rail this is obtained.

It will be noted that, although in the pressure-contact type of bonding the contacts when new may have an absolutely negligible

resistance, the resistance of the path for the return current is increased by the resistance due to the length of the bond itself. For this reason it is desirable to make such bonds as short as possible. On the other hand, the shorter the bond the less is its flexibility and the greater is the liability to deterioration, and, as a matter of fact, fairly long bonds are used for this more important reason. In newly and correctly bonded roads, the resistance of the bonded rail return need rarely be more than 5 per cent. greater than that due to the rail itself. The deterioration of bonding is generally rather rapid; at the end of a few years at the longest, the resistance will in many cases be increased to a considerable percentage. These remarks refer to the resistance of the metallic circuit on the assumption that no current flows by the earth. As a matter of fact, however, large percentages of the current return by the earth, thereby greatly reducing the voltage drop. This is liable to lead to undesirable consequences through the electrolysis of waterpipes and ironwork in general, located below the street level, and Board of Trade regulations have been framed with a view to limiting this danger.

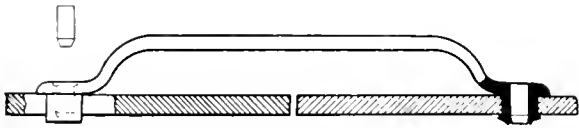

Fig. 247. CROWN RAIL BOND.

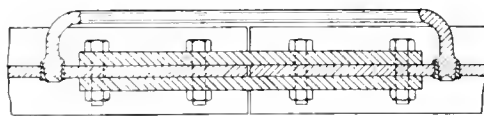

Fig. 248. COLUMBIA RAIL BOND.

ELECTRIC RAILWAY ENGINEERING

Soldered Rail Bonds.

In this type of bond, the continuity is made from rail to rail by means of a strip or bundle of strips of copper actually soldered on to the rails.

Tests and inspection after several years' working on several roads are said to have shown the bonds and contacts to be in as good condition as when installed. It is

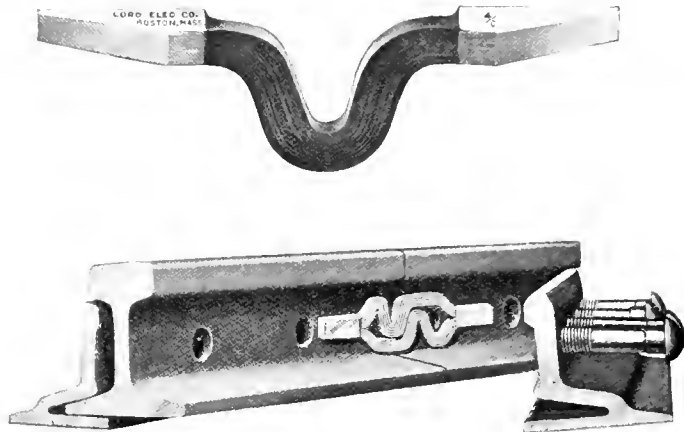

Fig. 249. THOMAS' SOLDERED RAIL BONDS.

stated that the Thomas Bond (Fig. 249) has been in use for over 3 years on the Boston Elevated Railway, the Berkshire Street Railway, and the Chicago and Milwaukee Electric Railway. Fig. 249 will explain the construction of this bond, in which the

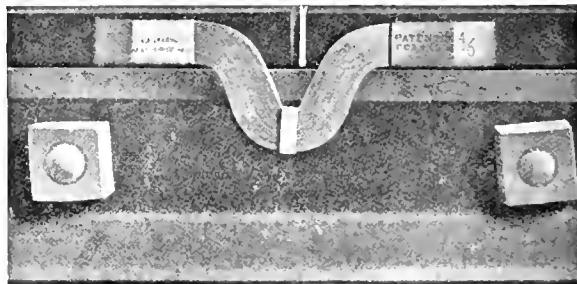

Fig. 250. SHAWMUT SOLDERED RAIL BOND.

bond, besides being soldered on to the rails, is pressed against them by the fish-plate when bolted on.

Fig. 250 depicts several types of the Shawmut soldered bond. This bond is similar to the Thomas type. The bond is built of flexible copper ribbon, and can be fixed on the web, or base, or ball of the rails, or from the web to a fish-plate, as shown.

THE DISTRIBUTING SYSTEM

Resistance of Bonds.

Table LXXIX., compiled from tests made by one of the authors,¹ gives some data as to the resistance of bonds.

TABLE LXXIX.

Resistances of Rail Bonds.

	Resistance in Microhms of Two Terminals in Series.	Resistance of Terminals only Single Bonding per Mile Single Track.	Conditions of Bonding.
$\frac{7}{8}$ -in. copper bond (40 terminals, web of rail $\frac{3}{8}$ in. thick, hole in rail $\frac{7}{8}$ in. in diameter, contact area 1.37 sq. ins.	1.97	173.5	Clean bond, clean hole, drilled without oil, well bonded.
	2.15 } average 2.06	189.5 } average 181.5	
$\frac{7}{8}$ -in. copper bond (40 terminals, same as above	2.50	220	Bond well bonded, hole drilled with oil.
Copper bond, $\frac{7}{8}$ -in. hole, web of rail $\frac{3}{8}$ in. thick, contact area 1.37 sq. ins.	7.2	635	Hole clean, well bonded.
	9.5 } average 7.7 } 8.1	835 } average 680 } 716	

Table LXXX., from "The Engineering and Electric Traction Pocket-book" (Dawson, 1903), gives further data of bond resistances from tests:—

TABLE LXXX.

Comparison of Resistances of various Rail Bonds, not including in any case the Resistance of the Rail.

Test Number.	Kind of Bond.	Current in Amperes.	Difference of Potential in Volts	Resistance in Ohms.
1	One 4 0 plastic copper bond	1.915	0.0234	0.0000122
2	Two	1.915	0.0127	0.00000668
3	One 6 0	1.910	0.0111	0.00000593
4	Two	1.880	0.00678	0.0000036
5	One 2 0 copper bond with steel driving pin	1.610	0.75	0.00046
6	Two	1.805	0.278	0.000154
7	One 4 0 flexible copper bond	1.830	0.119	0.000065

The tests from which the above results were obtained were carried out by the Ecole d'Electricite, under the auspices of the French Government, at Paris in July, 1900.

Table LXXXI. gives particulars of rail bonds employed on a number of typical railways.

¹ "Earth Returns for Electric Tramways," H. F. Parshall, *Journal Institute Electrical Engineers*, Vol. XXVII., p. 440.

ELECTRIC RAILWAY ENGINEERING

TABLE LXXXI.

Particulars of Rail Bonds on various Railways.

Railway.	Number of Bonds per Joint.	Build of Bond.	Name and Manufacturer of Bond.	Total Cross-section of Bonds.	
				Square Inches.	Circular Mils.
Baker Street and Waterloo	4	Flexible plated wire	American Steel and Wire Co.	—	—
Boston Elevated . . .	1	—	—	.236	300,000
Central London . . .	4 (third rail) 2 (track rail)	Flexible plated wire	Chicago Crown	.62 .31	790,000 395,000
City and South London .	2	Flexible wire	—	.165	210,000
Jackson and Battle Creek	2	Foot bonds	—	.236	300,000
Lackawanna and Wyoming Valley Railway	2	Foot bonds	—	.314	400,000
Lancashire and Yorkshire	4	Semi-flexible copper ribbon	Forest City Electrical Co.	—	—
Manx Electric Railway .	—	Rigid and flexible bonds	Columbia, Chicago Crown	—	—
Mersey Railway . . .	—	Flexible copper strip	Forest City Electrical Co.	.314	400,000
Metropolitan and District	4	Flexible copper strip	Forest City Electrical Co.	—	—
Neuchatel	1	Flexible copper wire	Chicago Crown	.155	197,500
New York, New Haven, and Hartford Railway	2	Flexible copper strip and cable	—	1.415	1,800,000
New York Subway . . .	4 (third rail) 2 (track rail)	—	Mayer and Englund Co.	.943 .314	1,200,000 400,000
North-Eastern	2	Flexible copper wire	Crown Bond, British Thompson-Houston	.166	212,000
Paris Metropolitan . . .	4	Flexible copper wire	Chicago Crown	.316	402,500
Paris-Versailles . . .	Third rail Track rail	—	—	.93 .2325	1,180,000 296,000
Seattle-Tacoma Railway .	Third rail Track rail	—	Clarke Bond, by Chase Shawmutt	.59 .393	750,000 500,000

Resistance of Rails to Alternating Currents.

In traction by alternating currents, either multi-phase or single-phase, use is made of the rails as part of the conducting circuit in order to lessen the amount of overhead constructional work. Owing, however, to the greatly increased resistance of iron to alternating currents, the use of the rails as a conductor is limited to short lengths, the rails being supplemented by a copper conductor, to which they are connected at short intervals. The virtual resistance of iron or steel conductors to alternating currents is a somewhat complicated phenomenon: it varies with the periodicity of the currents, the area and form of conductor, and the permeability. The latter, again, depends upon the current in the rail; therefore any statements of the virtual resistance of iron or steel to alternating currents is not completely defined unless all the conditions listed above are specified.

The resistance referred to here is a true ohmic resistance, which is increased owing to the tendency of the currents to keep to the outer layers of the conductor and avoid magnetisation of the material, thus limiting the effective area of the material for conducting purposes. Combined with the resistance effect is the inductance within

THE DISTRIBUTING SYSTEM

the rail, which tends to diminish as the resistance increases. The total drop on a rail is that due to the resistance and inductance, the resultant of which is the impedance.

The variation in permeability constitutes a difficulty in the predetermination of the impedance and its components: the permeability depends on the magnetization, which, again, depends upon the current in the rail. The permeability is apparently very low for small currents—say, less than 20 amperes per square inch—but increases rapidly when the currents are increased. At still higher current values, the permeability decreases.

Owing to the complexity of the phenomenon, impedance values can only be obtained by experiments. Experiments were carried out by one of the Authors upon the conductor rails of the Central London Railway. These rails were specially rolled for high conductivity, viz., 7 times that of copper, and are of channel section, weighing 80 lbs. to the yard.

The circuit consisted of two rails, of the quality and form stated above, placed 14 ft. apart, the length of each rail being 1.695 yds. Alternating currents having a periodicity of 25 cycles per second, were passed through the rails, and the following results obtained:—

Current in Amperes.	Difference of Potential in Volts.	Impedance.
164	179	1.09
180	200	1.11
195	232	1.19

The resistance of the circuit for continuous currents is 0.0694 ohms, and the impedance of the rails, due to the resistance and inductance within the rails, deduced from the above readings and taking average values, is 0.78, or a drop of 11 times that for continuous currents; the resistance component is 0.5, which is 7.2 times the resistance to continuous currents.

Inasmuch as so much depends upon the form of the rail and its magnetic and electrical properties, the behaviour of track rails cannot be deduced from these readings. A very exhaustive investigation into the electrical and magnetic properties of track has been carried out by Prof. Wilson, of King's College (see *Electrician*, of 23rd February, 1906), and determinations were made of the inductance and resistance of bull headed rails of standard section and weighing 70 lbs. to the yard, also the inductance of a circuit formed of one rail and two rails with an overhead conductor placed at different heights. The rails experimented on had a specific resistance of 8.45×10^{-6} per cubic inch, the resistance being 13 times that of copper, and presumably the permeability was of low value. Inasmuch as the conductivity, permeability and form of section is different, the results differ from the results obtained by us as quoted above.

Measurements of inductance values were made with currents of 50, 100, 150 and 200 amperes passing through the rail, and at periodicities of 100, 50 and 27 cycles per second. The results show how the inductance and resistance varies with current and periodicity, also the effect of the mutual action of the currents and the overhead conductor. The information obtained is such as to enable values to be obtained for different heights and different periodicities. With regard to rails of different sizes, Prof. Wilson suggests that a very close criterion of the properties of different sizes of the same form and of different forms is obtained from the periphery; this principle has been adopted by us in determining the properties of the different rails.

The following tables have been deduced from Prof. Wilson's experiments and

ELECTRIC RAILWAY ENGINEERING

apply to standard sections of bull headed rails; for periodicities of 15, 20 and 25 cycles per second, the values given are assumed to be constant for different currents. This does not hold for large variations, but if we limit the current to 20 amperes per square inch, which is a serviceable limit, the variation below this, at the periodicities given, is within the limits of the variation of magnetic properties of rail material and within the limits of errors in observation. The values given hold for rails of the same specific resistance as that experimented on, and inasmuch as the rail was obtained from one of the principal railway companies, it is reasonable to assume that it is fairly representative as regards its mechanical, magnetic and electrical properties, of the railway rails in general use in this country.

The impedance values given with the Tables take account of the inductance within the rail only and represent values which would be obtained were the return current carried in a closely fitting tube outside the rail; when stated in this form the values can be applied to calculate the impedance of the circuit with the overhead conductor at different heights.

Table LXXXII. gives resistances, reactances, and impedance per mile of single rail for rails of different weights for currents at 25 cycles.

TABLE LXXXII.

Resistance, Reactance and Impedance per mile of Bull Head Rails. Standard Section, 25 cycles per second.

Weight of Rail lbs. per yard.	Inductance.	Reactance.	Virtual Resistance (ohms).	Impedance.	Resistance to Continuous Currents (ohms).	Ratio of Drop AC CC
60	·00164	·257	·170	·308	·0925	3·33
70	·00156	·245	·162	·295	·0792	3·74
80	·00149	·233	·155	·280	·069	4·05
90	·00142	·223	·148	·267	·0618	4·32
100	·00136	·214	·142	·257	·0556	4·62
110	·00131	·206	·136	·247	·0505	4·89

Table LXXXIII. gives the same constants for currents of 20 cycles.

TABLE LXXXIII.

Resistance, Reactance and Impedance per mile of Bull Head Rails. Standard Section, 20 cycles per second.

Weight of Rail lbs. per yard.	Inductance.	Reactance.	Virtual Resistance (ohms).	Impedance.	Resistance to D. C. (ohms).	Ratio of Drop AC CC.
60	·00171	0·215	0·147	0·261	·0925	2·82
70	·00163	0·205	0·14	0·249	·0792	3·14
80	·00155	0·197	0·134	0·24	·069	3·47
90	·00149	0·187	0·128	0·237	·0618	3·67
100	·00142	0·179	0·122	0·217	·0556	3·90
110	·00137	0·172	0·117	0·208	·0505	4·12

THE DISTRIBUTING SYSTEM

Table LXXXIV. gives the constants for currents of 15 cycles.

TABLE LXXXIV.

Resistance, Reactance and Impedance per mile of Bull Headed Steel Rails. Standard Section, 15 cycles per second.

Weight of Rail lbs. per yard.	Inductance	Reactance.	Virtual Resistance (ohms).	Impedance.	Resistance to D. C. (ohms).	Ratio of Drop A.C. C.
60	·00182	0·171	0·129	·214	·0925	2·31
70	·00173	0·163	0·123	·204	·0792	2·57
80	·00165	0·156	0·117	·195	·069	2·83
90	·00158	0·149	0·112	·186	·0618	3·0
100	·00151	0·143	0·107	·179	·0556	3·22
110	·00145	0·137	0·103	·172	·0505	3·4

Impedance of Overhead Circuit with Rail Return.

The inductance of a circuit consisting of a copper conductor placed overhead with a return conductor on the ground, is a considerable factor and one which must be taken into account where alternating currents are used. Having already submitted Tables of inductance for a single rail of a standard form of section of different sizes, we have now to calculate the inductance of a pair of rails placed 4 ft. 8½ ins. apart with an overhead conductor placed at a particular height. The impedance of the circuit so formed comprises the resistance and reactance of the overhead conductor, the resistance of the rails, the inductance within the rails, the inductance of the circuit bounded by the rails and overhead conductor and the mutual induction of the currents in the two rails. Owing to the impedance of the rail circuit, the track rails are not used to a great extent except in conjunction with boosters and copper conductors. As however, part of the circuit in such cases consists of the overhead conductor with track rails for a return, we submit a table of resistances, reactances, and impedances for a system consisting of a standard track with 60 lbs., 80 lbs., and 100 lbs. rail, also resistance and impedance of overhead conductor of No. 4.0 s.w.g., the values of reactances and impedances being given for 15, 20 and 25 cycles per second.

TABLE LXXXV.

Impedance of Rail portion of Circuit.

Weight per yard—lbs. Resistance per mile— ohms.	100 ·0278			80 ·0345			60 ·0462		
Cycles per second ...	25	20	15	25	20	15	25	20	15
Radians per second..	157	125	94·2	157	125	94·2	157	125	94·2
Reactance	·26	·207	·16	·27	·216	·168	·28	·227	·177
Resistance	·071	·061	·053	·077	·067	·058	·08	·074	·065
Impedance	·265	·216	·17	·28	·227	·178	·293	·239	·188
Ratio alternate to continuous current drop	9·5	7·8	6·1	8·1	6·58	5·17	6·34	5·17	4·06

ELECTRIC RAILWAY ENGINEERING

Table LXXXV. gives the reactance, resistance and impedance per mile for the track portion of the circuit consisting of two rails with overhead conductor 20 ft. above rails for three weights of rails and for three different periodicities.

This Table gives the ratio of the drop between two points in the track one mile apart for alternating currents in terms of the drop for continuous current under the conditions given.

Under normal conditions, and for 25 cycles, which is a common frequency, the drop on the rails with alternating currents may be said to be roughly ten times the drop with continuous current. In consequence, the use of the rails for this purpose is very limited, and in practice the rails are supplemented by copper conductors, to which the rails are connected at frequent intervals. The rails and copper conductors form a return circuit in contact with earth, and therefore subject to the Board of Trade regulations affecting earthed conductors already quoted. In order to keep the drop within the limits prescribed, and in order to limit the amount of copper used, it is necessary to provide arrangements for limiting the drop in the rails. This object may be obtained by means of track boosters. One arrangement is that used by the Oerlikon Company, in which the track current is transferred by boosters to a common return conductor. Another arrangement is that described by Carter, in his paper

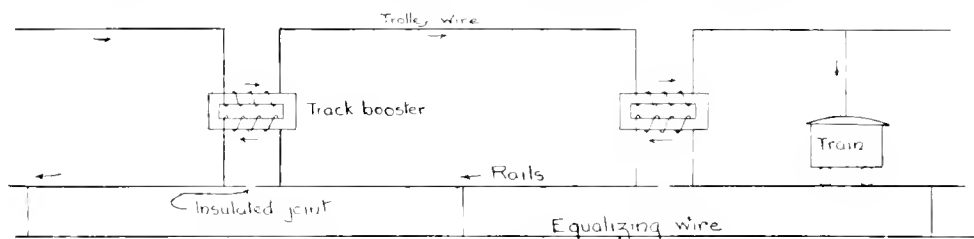

Fig. 251. ARRANGEMENT OF TRACK BOOSTERS FOR ALTERNATING CURRENTS.

read before the Institution of Electrical Engineers, 25th January, 1906, in which the track boosters are inserted at intervals along the track, the function being to induce an electro-motive force opposing the track drop. These boosters are transformers of ratio unity, of which the primary is connected across a section insulated in the trolley wire, and the secondary across an insulated joint in the track, shown diagrammatically in Fig. 251. The transformers are secured on poles or gantry posts, and are provided with switches for cutting out the transformer when desired.

We next deal with the resistance, reactance, and impedance due to currents in the overhead conductor, assuming that practically all the current is carried by the copper conductor.

Table LXXXVI. gives the values for a mile of circuit for three different periodicities.

TABLE LXXXVI.
Impedance of Overhead Conductor.

Cycles per Second.	Radians per Second.	Reactance.	Resistance.	Impedance.	Ratio Alternate to Continuous-Current Drop.
25	157	0.37	0.342	0.504	1.47
20	125	0.295	0.342	0.452	1.32
15	94.2	0.223	0.342	0.408	1.19

THE DISTRIBUTING SYSTEM

Table LXXXVII. gives the total impedance per mile of circuit for three periodicities and three weights of rail.

TABLE LXXXVII.
Total Impedance per Mile of Circuit.

Wt. of Rail. lbs. per yd.	25 cycles.			20 cycles.			15 cycles.		
	Reactance.	Resistance.	Impedance.	Reactance.	Resistance.	Impedance.	Reactance.	Resistance.	Impedance.
100	0.65	0.422	0.775	0.522	0.417	0.668	0.40	0.407	0.571
80	0.64	0.419	0.765	0.511	0.41	0.655	0.39	0.400	0.558
60	0.63	0.413	0.753	0.502	0.404	0.644	0.38	0.395	0.548

It will be seen on referring to the above Table, that the difference in the impedance values for the different conditions, are much reduced. This is owing to the effect of the resistance of the overhead conductor. The effect of the impedance of the rail and overhead conductor upon the power factor, depends upon the voltage of transmission, and also upon the power factor of the train circuit.

With 500 kilowatts transmitted, and with 5,000 volts in the line, the drop in voltage is 13 per cent. If the voltage be 3,000 volts, and the same power transmitted, the drop is 30 per cent. over the mile length. These results enable the distance between feeding points to be determined when the voltage on the circuit is selected.

Leakage from Track Rails.

Where track rails are used as conductors and form part of the return circuit, regard must be had to the amount of current which passes from the rails to the earth. These currents, if not kept within limits, may injuriously affect electric cables, water pipes, gas pipes, and telephone lines. The injury is caused mainly by electrolytic action, and of the metals employed for the purposes mentioned, lead is the most susceptible to injury, its electro-chemical equivalent being much higher than copper or iron. The Board of Trade have issued regulations affecting the working of electric tramways and tube railways, but no regulations are in force affecting the working of main line railways, and such regulations as are in force do not apply to alternating currents. There is no doubt, however, but that the limits as to the permissible amount of stray currents, must be observed by railways in their own interest. Owing, however, to the difference between the construction of railways and tramways, the leakage surface is less, and it will be possible to transmit greater distances for the same amount of leakage. If we assume a certain length of track, and that a current is put in at one end and taken out at the other, it will be found that the current actually in the rail will diminish towards the middle of the portion of line under consideration. The current will leave the rail over the half section remote from the source, and will return to the rail over the half section nearest the source. The distribution of current density and potential along the rail under tramway conditions, was thoroughly investigated by Mr. Evan Parry.¹ The potential and current at any

¹ "Fall of Potential along Tramway Rails," E. Parry, *Electrician*, August 10th, 1900.

ELECTRIC RAILWAY ENGINEERING

point of the rails is expressed as an exponential function of the distance from the source and the point chosen, and of the ratio of the cross sectional resistance of the rail to the contact resistance. Inasmuch as the resistance of rails to alternating current is greater than their resistance to continuous currents, the values of the current and potential along the line differ greatly. The specific values for steel of different compositions have already been tabulated, and also the resistance to alternating currents of three different periodicities. The first function referred to, or the contact resistance between the rail and earth is not so definitely ascertainable: the leakage surface consists in the main of the chair supporting the rail. The current being dissipated to earth by means of the wooden sleeper, the amount of leakage will depend, to some extent, upon the state of the weather. From measurements made on a length of track, we conclude that the surface resistance may be taken at 1,500,000 ohms per sq. in. under average conditions. Table LXXXVIII. shows the current entering the rail and the corresponding current density for different lengths of track with

TABLE LXXXVIII.

Table of Current Values in Track Rails for 10 Volts Difference of Potential between ends of Rail for 100 lb. Rail.

Dis- tance in Miles	C.C.			25 cycles.			20 cycles.			15 cycles.		
	Density per square inch.	Total Current.	Per- centage Leakage.	Density per square inch.	Total Current.	Per- centage Leakage.	Density per square inch.	Total Current.	Per- centage Leakage.	Density per square inch.	Total Current.	Per- centage Leakage.
1	21.4	207	0.5	1.74	16.85	1	2.62	24.9	1.8	4.22	40.5	0.8
2	10.7	104	0.8	0.897	8.7	4.8	1.33	12.7	3.8	2.14	21.4	2.0
3	7.2	70	1.2	0.62	6.0	10.5	0.91	8.73	7.0	1.44	13.8	4.2
4	5.42	52.5	1.5	0.49	4.75	17.3	0.7	6.72	11.5	1.11	10.6	7.3
5	4.33	41.8	2.0	0.415	4.02	22.8	0.58	5.56	17.5	0.914	8.76	11.7
6	3.66	35.4	2.5	0.371	3.6	31.9	0.517	4.97	24.5	0.79	7.58	17.0
7	3.12	30	3.8	0.31	3.3	41.2	0.47	4.5	33.0	0.7	6.72	23.0
8	2.72	26.3	5.5	0.322	3.12	48.0	0.43	4.12	41.0	0.64	6.14	28.8
9	2.46	23.9	8.0	0.307	2.97	54.4	0.41	3.93	47.0	0.59	5.66	32.8
10	2.3	22.2	10.0	0.3	2.89	61.0	0.39	3.7	50.0	0.56	5.37	35.8

10 volts difference of potential between the two ends. The values are given for a 100 lb. rail and for continuous currents as well as for alternating currents of 15, 20 and 25 cycles. For continuous currents, the values of current density will apply to all sizes of rails, but they differ for alternating currents owing to the variation of virtual resistance with the area of rail. The Table also shows the percentage of leakage from the rail. It should be noted that the percentage of leakage is much greater in the case of alternating currents. The limitations in the transmission of alternating currents are clearly brought out in the Table; referring, for instance, to the case of transmission over four miles, the amount of continuous current which may be transmitted with a potential difference of 10 volts is 52.5 amperes per rail, and leakage 0.8 of an ampere, or 1.5 per cent. of the total current transmitted; whilst for alternating currents of 25 cycles frequency, the current transmitted for the same potential difference is six amperes per rail, and the leakage practically the same as in the case of continuous current, and equivalent to 17.3 per cent. of the total current.

THE DISTRIBUTING SYSTEM

TABLE LXXXIX.

Table of Pressure Differences on Track Rails with 100 Amperes in Rail—100 lb. Rail.

Distance in Miles.	C.C.		25 cycles.		20 cycles.		15 cycles.	
	D.P. in Volts.	Leakage, Amperes.	D.P. in Volts.	Leakage, Amperes.	D.P. in Volts.	Leakage, Amperes.	D.P. in Volts.	Leakage, Amperes.
1	4.83	.5	59	1	40	1.8	25	.8
2	9.62	.8	115	4.8	79	3.8	47	2.0
3	14.2	1.2	166	10.5	115	7.0	72	4.2
4	19	1.5	210	17.3	149	11.5	91	7.3
5	23.8	2.0	249	22.8	180	17.5	114	11.7
6	28.2	2.5	278	31.9	200	24.5	131	17.0
7	33.3	3.8	303	41.2	222	33.0	149	23.0
8	38	5.5	320	48	243	41.0	166	28.8
9	42	8.0	337	54.4	251	47.0	177	32.8
10	45	10.0	346	61	267	50.0	186	35.8

Table LXXXIX. gives the potential difference for varying distances of transmission in a track with 100 lbs. rail carrying 100 amperes per rail. Take the case of a four-mile transmission; continuous current could be transmitted with a potential difference of 19 volts and a leakage of 1.5 amperes, whereas to transmit alternating currents of 25 cycles periodicity the same distance requires a potential difference of 210 volts, and the leakage would be 17 amperes.

In the case of tube railways care should be taken to provide against contact between rails forming part of a return system and the lining of the tunnel, except only at or near the source of supply to the distributing circuit. The tube lining has an enormous dissipating surface compared with its cross sectional area, in consequence of which the leakage of current is promoted to an abnormal extent, even although the sections of the tunnel lining are well bonded.

Part III

THE ROLLING STOCK

Chapter IX

LOCOMOTIVES AND MOTOR CARRIAGES AND THEIR ELECTRICAL EQUIPMENT

ONE of the most important questions arising in connection with the electrification of railways relates to whether electric locomotives, or motor cars, shall be employed. Electric locomotives will, of course, invariably be used for freight haulage, so far as this work comes to be done electrically, but for passenger trains, electric locomotives do not possess an exclusive claim for consideration for all

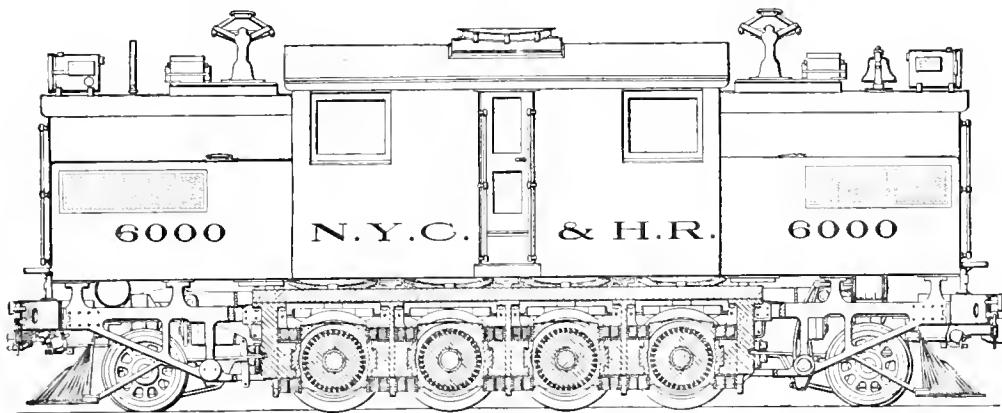

Fig. 252. ELECTRIC LOCOMOTIVE FOR NEW YORK CENTRAL RAILROAD. WEIGHT, 85 METRIC TONS.

classes of traffic. The alternative consists in trains made up partly or entirely of motor cars, operated on the multiple unit control principle.

For long distance passenger trains, there are sound advantages in the use of trains hauled by electric locomotives as compared with motor car trains, though for urban and suburban traffic these advantages will frequently be exceeded by the advantages of motor car trains. In the transition stage from steam to electric operation, it will involve less disarrangement of the traffic conditions to employ electric locomotives to a certain extent. As an instance may be mentioned the case of the New York Central and Hudson River Railroad Co., which has now embarked upon the most extensive scheme of heavy electric traction which has yet been undertaken. The tracks of this railway enter New York through an extensive system of tunnels, and it has long been recognised that it would be of great advantage on the score not only of cleanliness and hygiene, but of safety, to replace steam by electricity. This has led the New York

ELECTRIC RAILWAY ENGINEERING

Central Railway to undertake the replacement of its steam suburban service by an electric service, and the multiple unit system, with the motors under the carriages, has been adopted for all suburban trains. The railway is now electrically equipping its New York terminal for a distance of 34 miles on the main line from the Grand Central Station to Croton, and for 24 miles on the Harlem division, as far as White Plains. All passenger traffic within this district or zone will be handled electrically, and the electric locomotive recently designed and built by the General Electric Co. and the American Locomotive Co. is the first of thirty-five for which orders have already been placed, and which will be used in the hauling of through passenger trains. According to the specified conditions, the service demanded of this type of locomotive is as follows. It is capable of regularly making the trip from the



Fig. 253. ELECTRIC LOCOMOTIVE FOR NEW YORK CENTRAL RAILROAD. WEIGHT, 85 METRIC TONS.

Grand Central Station to Croton, a distance of 34 miles, hauling a total train weight of 400 metric tons, in 41 minutes without a stop. This corresponds to a speed of 46 miles per hour. The heaviest of these trains weighs 800 metric tons, and is drawn by two of these locomotives. The locomotive is able to haul a 400-ton train at a maximum speed of 70 miles per hour. Two locomotives, equipped with the multiple unit control system, are used to haul an 800-ton train at a maximum speed of 70 miles per hour.

General Arrangement and Dimensions of the New York Central Locomotives.

The designers have sought to secure in this locomotive the best mechanical features of the high speed steam locomotive, combined with the greatly increased power and the simplicity in control made possible by the use of electricity.

The locomotive is illustrated in Figs. 252 and 253. It has four driving axles, on

LOCOMOTIVES AND MOTOR CARRIAGES

each of which is mounted the armature of a gearless electric motor having a normal rating of 550 h.-p. The total rated capacity of the locomotive is 2,200 h.-p. when estimated in accordance with the customary 1-hour basis of nominal rating of railway motors. For short periods, however, a considerably greater power may be developed, giving the locomotive greater capacity than the largest steam locomotive in existence.

The principal dimensions of the locomotive, and other data regarding it, are given in Table XC.¹

TABLE XC.

Loading Data of New York Central Electric Locomotive.

Number of driving wheels	8
Number of truck wheels	4
Weight	85 metric tons
Weight on drivers	68 metric tons
Wheel base, driving	13 ft.
.. .. total	27 ft.
Maximum tractive force	34,000 lbs.
Ditto per metric ton engine weight	400 lbs.
Wheels, driving	44 ins. dia.
.. engine truck	36 ins. dia.
Length over buffer platforms	37 ft.
Extreme width	10 ft.
Height to top of cab	14 ft. 10 ins.
Diameter of driving axles	8.5 inches.
Normal rated power	2,200 h.-p.
Maximum power	3,000 h.-p.
Speed with 450-ton train	60 m.p.h.
Voltage of current supply	600
Normal full load current	3,050 amps.
Maximum full load current	4,300 amps.
Number of motors	4
Type of motor	GE-84-A
Rating of each motor	550 h.-p.
Weight of motor—excluding yokes which are built into the locomotive frame—but including axle	11,200 lbs.
Ditto, excluding axle	9,430 lbs.

The weight of the electrical equipment per locomotive is made up as set forth in Table XCI.

TABLE XCI.

Weight of Electrical Equipment of New York Central Locomotive.

Total weight of four motors (excluding axles and also excluding yokes which are part of the locomotive frame, but including armature, field coils, and laminated poles)	37,700 lbs.
Weight of twenty rheostats	1,600 ..
Weight of two master controllers	600 ..
Weight of control equipment, including rheostats and master controllers	10,200 ..
Weight of air compressor	4,300 ..
Cables, cleats, etc.	3,000 ..
Total weight of electrical equipment	55,200 lbs., or 25 metric tons.

¹ This descriptive matter is partly compiled from bulletins published by the General Electric Co. of America, the contractors for equipping the road.

ELECTRIC RAILWAY ENGINEERING

The weight of the magnetic yoke which was furnished as part of the locomotive, and is not included in the above figures, as it also forms part of the mechanical frame of the locomotive, is 11,900 lbs., or 5.4 metric tons.

It would seem reasonable to add half of this to the weight of the electrical equipment, which is thus brought up to 27.7 metric tons, or **32.6 per cent. of the total weight of the locomotive.**

The largest of the present New York Central types of steam locomotives, *i.e.*, the "999" type, have a capacity of only 1,500 h.-p. per locomotive.

The Electric Motors for the New York Central Locomotives.

The motors mark an interesting and radical departure from ordinary motor construction. The designers have arranged the armatures directly upon the axles,

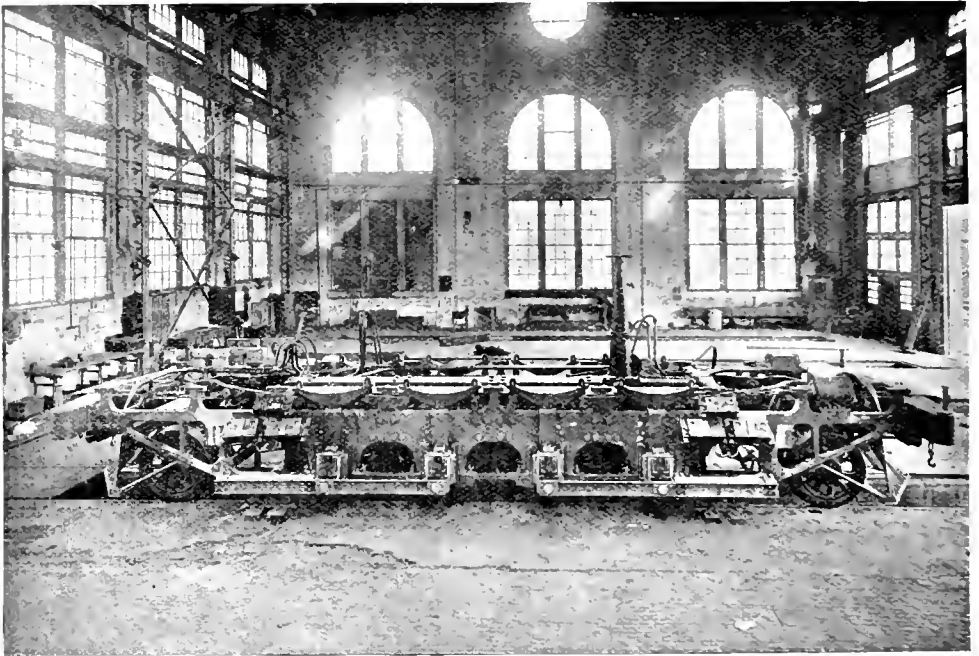

Fig. 254. ASSEMBLY OF TRUCK OF NEW YORK CENTRAL LOCOMOTIVE.

partly with a view to securing the advantage of direct application of power to the driving axles and to avoiding the losses of power in gear and pinion which are encountered in geared railway motors.

There are only two pole pieces, which are practically part of the truck frame, and have nearly flat vertical faces. There is no necessity, therefore, of preserving a rigid alignment between armature and field, and the armature can have a large free vertical movement without danger of striking the pole pieces. The maximum weight of the motor, consisting of its field and frame, is carried with the truck frame upon the journal box springs on the outside of the driving wheels.

This construction, besides being strong and simple in design, greatly facilitates repairs and renewals, as an armature, together with its wheels and axles, may be

LOCOMOTIVES AND MOTOR CARRIAGES

removed by lowering the complete element without disturbing the fields or any other part of the locomotive, and a new element may be inserted in its place. All parts are especially accessible for inspection and cleaning.

The dead weight on each driving axle is practically the same as on an ordinary steam locomotive, and is about 10 per cent. less than that on the heaviest types, while, in addition, there is no unbalanced weight to produce vibration, with attendant injuries to track and road bed construction. It is anticipated that this will effect such a reduction in the expense of maintaining the rails and road bed, due to the absence of pounding and rolling, as to have an important bearing on the upkeep of the permanent way.

A longitudinal section of the locomotive frame may be seen in Fig. 252. The main frame is of cast steel, and forms not only the mechanical frame of the locomotive, but also part of the magnetic circuit of the motors. It will be seen that the magnet fields are arranged in tandem, the end pole pieces being cast as part of the end frames, and the double pole pieces between the armatures being carried by heavy steel transoms bolted to the side frame, and forming part of the magnetic circuit as well as constituting

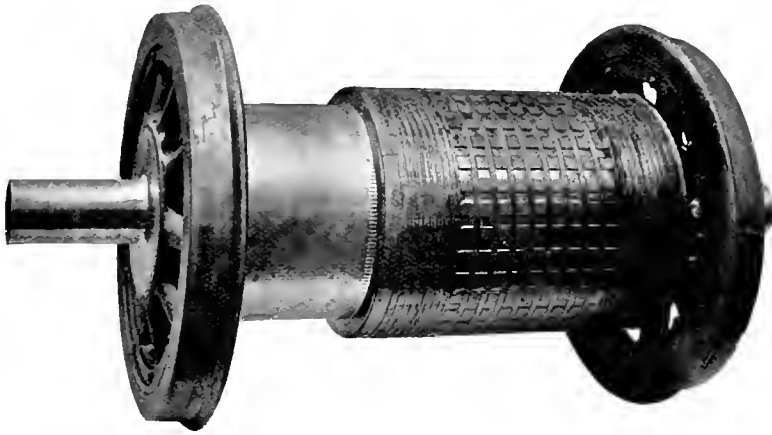

Fig. 255. MOTOR ARMATURE OF NEW YORK CENTRAL LOCOMOTIVE.

cross braces for the truck. The field coils are wound upon metal spools which are bolted upon the pole pieces. A suitable distribution and division of the weight of the locomotive among the axles has been accomplished by suspending the main frame and superstructure from a system of half-elliptic springs and equalised levers of forged steel, the whole being so arranged as to cross-equalise the load and to furnish three points of support. A photograph of the truck is shown in Fig. 254, while Fig. 255 shows a motor armature.

Control System of the New York Central Electric Locomotive.

The method of control is the multiple unit system. The engineer handles a small controller, which operates the control circuit. The current in this control circuit operates in turn the main contactors, admitting current to the power circuit. The master controller is located in the motorman's cab, while the contactors are located in the spaces at the forward and rear ends of the locomotive.

By use of this system, two or more locomotives can be coupled and operated from the leading cab as a single unit. The motive power may thus be adapted to the

ELECTRIC RAILWAY ENGINEERING

weight of the train. A single locomotive will be able to maintain the schedule with a 100-ton train, and two locomotives coupled together will be used to operate heavier trains, with a single engine crew operating both locomotives simultaneously.

The control system permits three running connections: namely, four motors in series, two groups of two in series-parallel, all four motors in parallel. The motor-reverser, contactors, rheostats, and other controlling appliances are all of the Sprague General Electric multiple unit type. The master controller is fitted with a special operating lever about 24 ins. long, and capable of being moved through an angle of about 75 degrees. A current-limiting device is provided in the master controller, and consists of a friction clutch operated by an electric magnet which is energised by the current passing through one of the motors, the arrangement being such that when

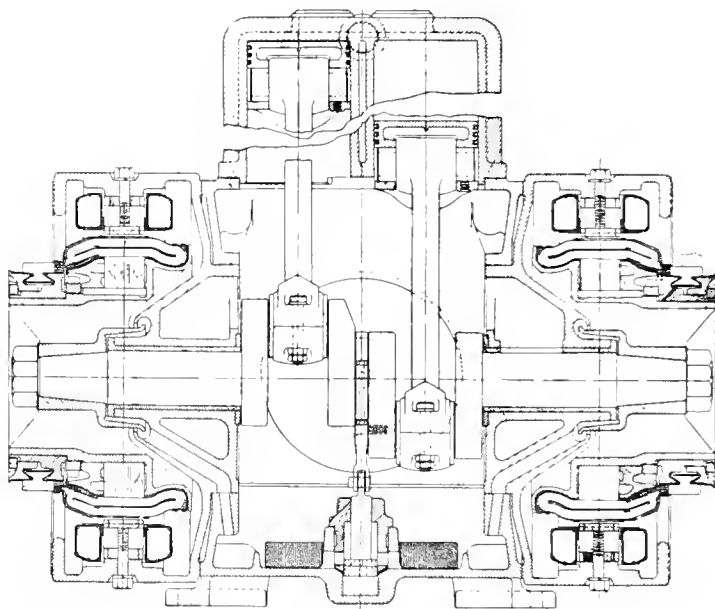

Fig 256. SECTIONAL VIEW OF AIR COMPRESSOR FOR NEW YORK CENTRAL LOCOMOTIVE.

the current exceeds a predetermined amount the cylinder cannot be rotated further until the current has fallen sufficiently to allow the relay to drop. As long as the current does not exceed the desired limit the automatic feature is not in operation.

Auxiliary Apparatus for the New York Central Locomotive.

The superstructure consists of a central cab for the operator, containing master controllers, engineer's valves for air brake, and switches and valves required for operating the sanding, whistling, and bell-ringing devices. This apparatus is furnished in duplicate, one set on each side of the cab, and is arranged so as to be easily manipulated from the operator's seat, while at the same time a practically unobstructed view to front and rear may be obtained from the windows. The air gauge, meters, etc., are located so as to be easily read by the driver.

There is a central corridor extending through the cab so as to permit access from

LOCOMOTIVES AND MOTOR CARRIAGES

the locomotive to the cars behind, and the contactors, rheostats, and reversers are arranged along the sides of these corridors in boxes of sheet steel, which are sheathed on the inside with fireproof insulating material. All of these appliances are, therefore, easily accessible for repairs or inspection.

In the operator's cab there is placed a motor-driven direct-connected air compressor, running at 175 revolutions per minute, and having a capacity of 75 cubic ft. of free

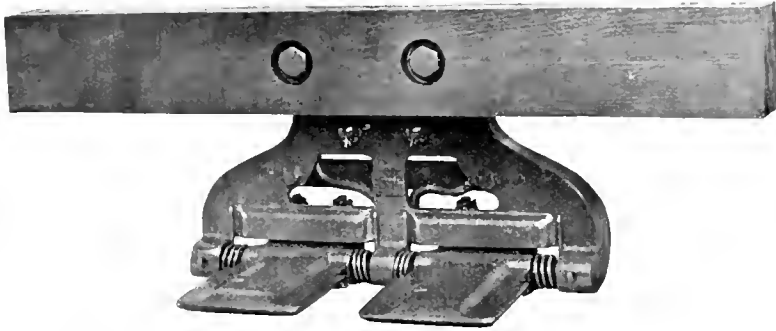

Fig. 257. THIRD RAIL SHOE OF NEW YORK CENTRAL LOCOMOTIVE.

air per minute. The compressor is controlled by a governor which automatically cuts the motors in and out of circuit when the air pressure falls below 125 lbs. or exceeds 135 lbs.

A sectional view of the compressor is shown in Fig. 256. To economise space and simplify the bearings, the compressor is provided with two motors, which are connected in series with each other. The compressed air is employed both for braking the train and blowing the whistle.

Contact Collecting Devices for the New York Central Locomotive.

Current is collected from the third rail by multiple-contact spring-actuated third-rail shoes, the supports of which are carried on channel irons attached to the journal box. A photograph of the third-rail shoe is given in Fig. 257. There are four of these shoes on each side of the locomotive. In the yards at the terminal, the large number of switches and crossings necessitates an overhead construction in places, and additional contact shoes, one of which is shown in Fig. 258, are, therefore, mounted on the top of the locomotive for collecting current when the locomotive is passing over these points. This device may be raised and lowered by air pressure controlled from the engineer's cab. A magnetic ribbon fuse is placed in circuit with each shoe and overhead contact device, so as to secure protection in case of accidental short circuit.



Fig. 258. OVERHEAD CONTACT DEVICE OF NEW YORK CENTRAL LOCOMOTIVE.

ELECTRIC RAILWAY ENGINEERING

New York Central Locomotive Tests.

In Fig. 259 are given the tractive force and speed curves for one of these locomotives when all four motors are connected in parallel, as published in 1904 by the General Electric Co., and presumably based on factory tests of the motors.

The New York Central and Hudson River Railroad Co. and the General Electric Co. are making extensive preliminary tests and trials of these locomotives under all conditions likely to obtain in service operation. For this purpose, the New York Central

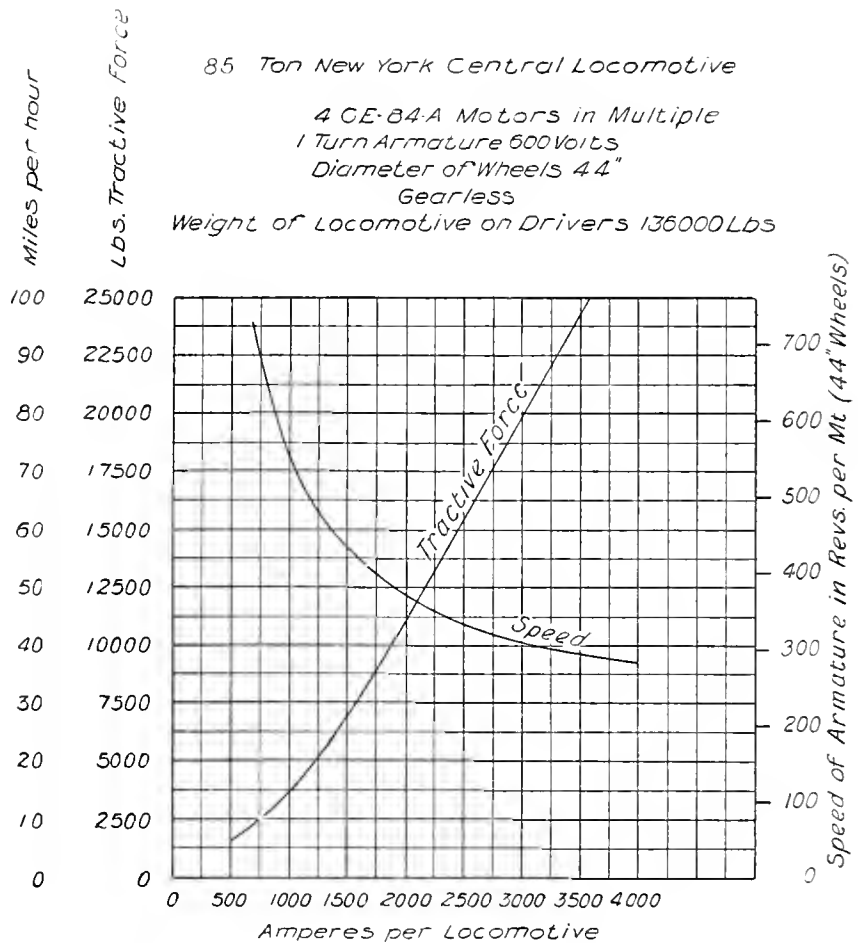

Fig. 259. CHARACTERISTIC CURVES OF NEW YORK CENTRAL LOCOMOTIVE.

and Hudson River Railroad Co. has set aside a 6-mile stretch of track on its main line between Schenectady and Hoffman's Ferry, and has equipped it with standard third-rail construction. The track is well ballasted and practically straight, and permits of attaining a maximum speed of from 70 to 80 miles per hour.

Power for operating the locomotive is furnished by the General Electric Co., of Schenectady, U.S.A., and for this purpose there has been installed in the new powerhouse at the Schenectady Works a 2,000-kilowatt three-phase 25-cycle Curtis turbine-generator delivering energy to the line at a pressure of 11,000 volts.

LOCOMOTIVES AND MOTOR CARRIAGES

A special high tension transmission line has been constructed from the power station for a distance of 5 miles to the sub-station at Wyatt's Crossing.

The sub-station contains a 1,500-kilowatt, 650-volt rotary converter with static transformers for reducing the pressure from 11,000 volts to 475 volts alternating current at the collector rings, and then to 600 volts continuous current for the locomotive.

The location and arrangement of the apparatus in the sub-station and the dimensions of the station are in general the same as for the sub-stations within the electric zone at the New York City terminus. The installation thus afforded practical experience with the system in detail in advance of construction, and while the locomotive tests were being made.

A complete set of recording instruments has been installed in the cab for the purpose of making these tests. These instruments, when in operation, indicate automatically and continuously the speed and power developed by the locomotive.

New York Central Locomotive Tests of November, 1904.

Two sets of curves are given in Figs. 260 and 261 showing the current input, voltage, and speed at the locomotive when starting,

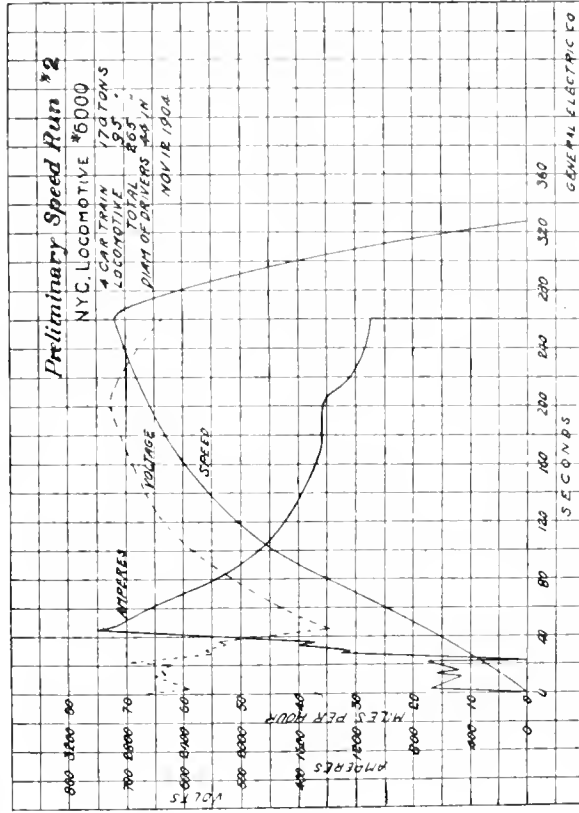

Fig. 261. CURVES OF CURRENT INPUT, VOLTAGE AND SPEED OF NEW YORK CENTRAL LOCOMOTIVE WITH FOUR-CAR TRAIN.

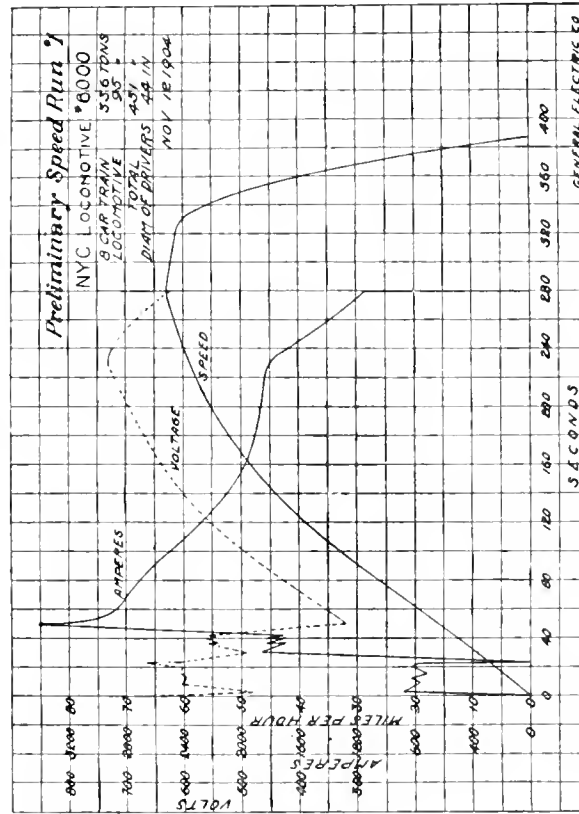

Fig. 260. CURVES OF CURRENT INPUT, VOLTAGE AND SPEED OF NEW YORK CENTRAL LOCOMOTIVE WITH EIGHT-CAR TRAIN.

ELECTRIC RAILWAY ENGINEERING

and running with an eight-car train weighing 300 metric tons and a four-car train weighing 155 metric tons, both exclusive of locomotive. The total weight of the train, including locomotive and passengers, was 390 metric tons and 240 metric tons for the eight-car and four-car trains respectively. The maximum speed reached was 63 miles per hour with an eight-car train, and 72 miles per hour with a four-car train.

It will be noted that the trains were still accelerating at these speeds, but the length of the track which had at that time been equipped did not permit of attaining higher speeds.

The New York Central locomotives were not designed for abnormally high speeds at intervals, but rather with a view to obtaining a high average schedule, due

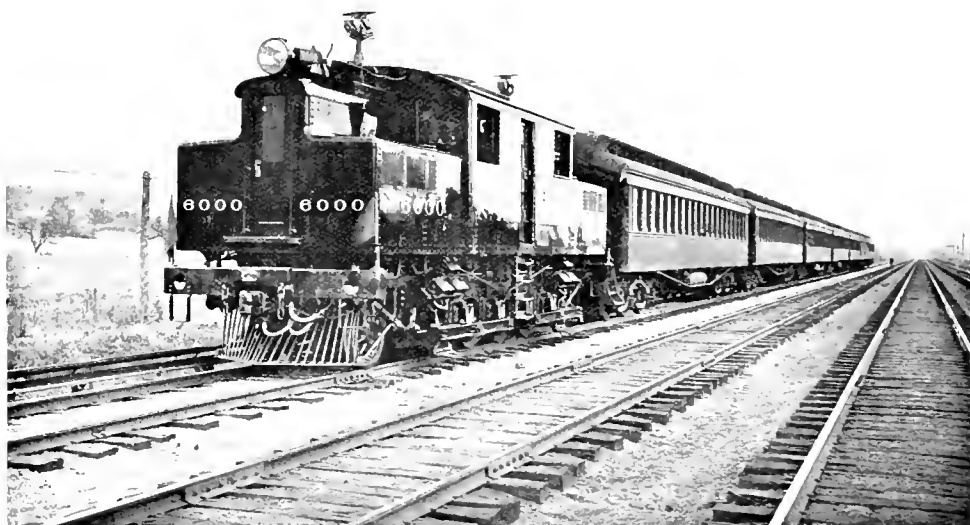

Fig. 262. NEW YORK CENTRAL LOCOMOTIVE HAULING A SIX-CAR TRAIN DURING ONE OF THE TESTS OF NOVEMBER, 1904.

to their ability to accelerate more rapidly than is possible with the present steam locomotive.

In starting tests, with an eight-car train weighing with the locomotive 390 metric tons, a speed of 30 miles per hour has been reached in 60 seconds, corresponding to an acceleration of half a mile per hour per second. During certain periods of the acceleration the increase in speed amounted to 0.6 mile per hour per second, requiring a tractive effort of approximately 27,000 lbs. developed at the rim of the locomotive drivers. This value was somewhat exceeded with the four-car train, where a momentary input of 4,200 amperes developed a tractive effort of 31,000 lbs. at the drivers, with a coefficient of traction of 22.5 per cent. of the weight on drivers. The average rate of acceleration with the four-car train, weighing, including the locomotive, 240 metric tons, was 30 miles in $37\frac{1}{2}$ seconds, or 0.8 mile per hour per second, calling for an average tractive effort of 22,000 lbs.

LOCOMOTIVES AND MOTOR CARRIAGES

The maximum input recorded, 4,200 amperes at 460 volts, or 1,935 kilowatts, gives a motor output of 2,200 h.-p. available at the wheel. With 4,200 amperes and a maintained potential of 600 volts there would have been an input to the locomotive of 2,520 kilowatts, corresponding to 2,870 h.-p. output from the motors. As this output is stated to be secured without exceeding the safe commutation limits of the motors, and with a tractive coefficient of 22.5 per cent. of the weight upon the drivers, the electric locomotive is placed well in advance of the steam locomotive.

Throughout both the starting and running tests the electric locomotive has shown remarkable steadiness in running, a distinct contrast in this respect to the steam locomotive, especially should the latter be forced to perform the work accomplished by the electric locomotive.

Fig. 262 is a photograph of the first locomotive when hauling a six-car train.

New York Central Locomotive Tests of April, 1905.

Further tests were made on April 29th, 1905, over the experimental track at Schenectady, N.Y., for the purpose of securing data on the relative acceleration and

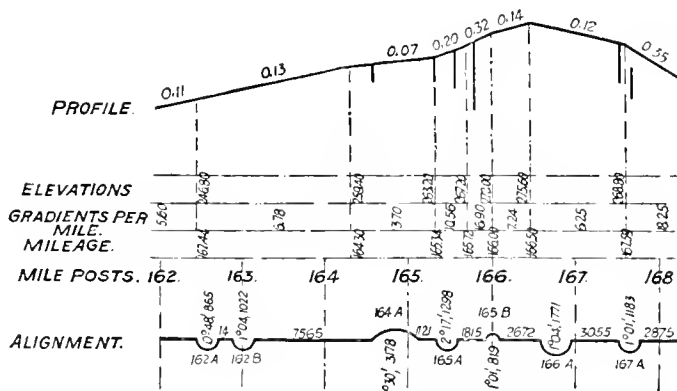

Fig. 263. --PROFILE OF ALIGNMENT AND GRADES OF NEW YORK CENTRAL EXPERIMENTAL TRACK.

speed characteristics of electric and steam locomotives. The tests were made with the New York Central type electric locomotive 6,000, already described, and on the Pacific type steam passenger locomotive 2,797. The data secured were intended for private information, but the results achieved were considered to be so remarkable that the parties concerned decided to make public a resumé of the runs.

Time of Test and Weather Conditions.

The test started about 8 a.m., and continued until about 1 p.m., of April 29th, 1905, temperature averaging about 50 degrees F. During the time of the test no rain fell, so that the rails were perfectly dry.

ELECTRIC RAILWAY ENGINEERING

Description of Experimental Track.

The experimental track, 6 miles in length, was the portion of old track No. 4 of the New York Central main line, formerly used for east-bound freight movements between mile-posts 162 and 168, west of Schenectady.

The track materials were 80-lb. standard New York Central section steel rail, with six-bolt 36-in. splices, sixteen yellow pine ties to the 30-ft. rail, gravel ballast, well surfaced, curves elevated for a speed of about 70 miles per hour.

The working conductor consisted of top-contact¹ 70-lb. steel rail reinforced with copper and covered in part with a board protection. At four crossings, overhead construction was used to cover gaps where the use of the third rail was inadmissible.

The alignment and grades are illustrated upon the condensed profile of Fig. 263. It will be noted that from the easterly end of the track at mile-post 162, going westerly, the rising gradients varied from 5 ft. to 17 ft. per mile to a summit between mile-posts 166 and 167, and thence the track descended on gradients varying from 6 ft. to 19 ft. per mile to the end of the track at mile-post 168. It will also be noted that in the 6 miles there were seven curves, varying from 0 degrees 48 minutes to 2 degrees 17 minutes, the maximum length of tangent being 7,565 ft.

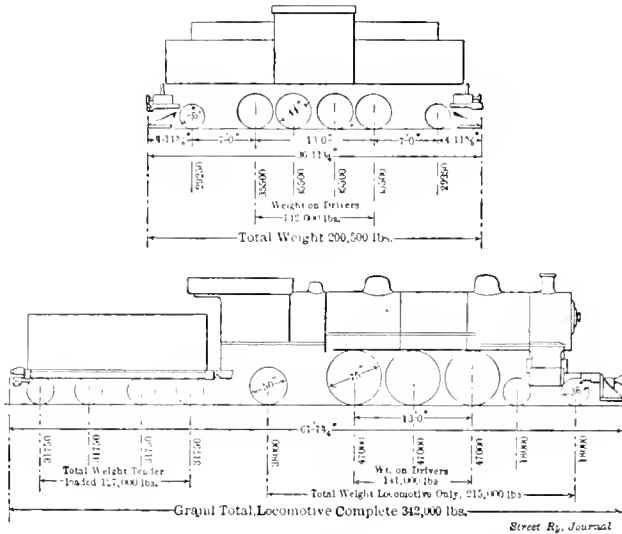

Fig. 264. DIAGRAM OF GOVERNING DIMENSIONS AND WEIGHTS OF NEW YORK CENTRAL STEAM AND ELECTRIC LOCOMOTIVES EMPLOYED IN TESTS MADE APRIL 29TH, 1905.

These were the same as for the tests of November, 1904. The sub-station was near mile-post 165.

Source of Power, Transmission Line, and Sub-station.

These were the same as for the tests of November, 1904. The sub-station was near mile-post 165.

Dimensions and Weights of the Test Trains.

The diagram of Fig. 264 illustrates the governing dimensions and weights of both locomotives. The weights of the cars are given in Table XCII.

¹ Experiments have also been made with an alternative type of under-contact rail which has a number of advantages over the ordinary top-contact third rail.

LOCOMOTIVES AND MOTOR CARRIAGES

TABLE XCII.

Composition of Trains in New York Central Tests of April, 1905.

	Electric Train.			Steam Train.	
	Car No.	Weight loaded, lbs.		Car No.	Weight, lbs. (No Load.)
Eight-car train—					
1	1,060	101,900	1	2,527	79,900
2	1,070	100,400	2	1,547	86,100
3	1,082	106,200	3	1,534	87,800
4	1,092	100,100	4	1,521	84,500
5	1,097	101,650	5	1,069	86,300
6	1,550	102,800	6	1,099	87,400
7	1,552	106,000	7	1,563	86,400
8	1,558	104,750	8	1,513	86,700
Locomotive	—	200,500	Locomotive	—	342,000
Total	—	465.5 tons.	Total	—	465 tons.
Six-car train—					
1	1,060	101,900	1	2,527	79,900
2	1,070	100,400	2	1,547	86,100
3	1,092	100,100	3	1,534	87,800
4	1,097	101,650	4	1,521	84,500
5	1,550	102,800	5	1,069	86,300
6	1,558	104,750	6	1,099	87,400
Locomotive	—	200,500	Locomotive	—	342,000
Total	—	370 tons.	Total	—	388 tons.

In Table XCIII., which gives the average voltage at the live rail during acceleration, it will be noted that, due to the restricted cross-section of conductors, the voltage during acceleration dropped considerably more than is the case in actual practice within the electric zone in the neighbourhood of New York. Therefore the results obtained in this comparative test are much less favourable for the electric locomotive than are secured in actual practice.

TABLE XCIII.

Average Voltage at Live Rail during Acceleration.

	Runs.	Series.	Series Multiple.	Multiple.
A		520	540	235
B		620	520	275
C		600	540	330
D		680	680	515
E		650	600	420
F		600	620	455

Schedule of Runs.

Run "A."—The "Pacific" type steam locomotive had an eight-car train with a total weight, including the locomotive, of 465.0 tons, as compared with the eight-car train including the electric locomotive weighing 465.5 tons. Both trains started together,

ELECTRIC RAILWAY ENGINEERING

with the steam locomotive accelerating faster than the electric locomotive, due to the abnormal drop in voltage from the pressure at the station of 700 volts to a track voltage as low as 235 volts. At 3,000 ft. from the starting-point, the electric locomotive gained the same speed as the steam locomotive, and from that point accelerated more rapidly, so that at a distance of 2 miles from the starting-point the electric locomotive passed the steam locomotive, and, at the shutting-off point, was two train lengths ahead.

Maximum speed of steam locomotive, 50 m.p.h.
Maximum speed of electric locomotive, 57 m.p.h.

Run "B."—This run was made under the same conditions as run "A," with results practically the same, except that the speeds were higher, as follows:—

Maximum speed of steam locomotive, 53.6 m.p.h.
Maximum speed of electric locomotive, 60 m.p.h.

Run "C."—This run was made with six-car trains for both locomotives, with total train weights as follows:—

Electric locomotive	370 tons.
Steam locomotive	388 ..

Owing to the extremely low voltage under the conditions above stated, which during acceleration fell as low as 330 volts, the steam locomotive at first accelerated more rapidly, but at the end of about a mile, the electric locomotive overtook the steam train and continued to forge ahead until the power was shut off.

Maximum speed of electric locomotive, 61.6 m.p.h.
Maximum speed of steam locomotive, 58 m.p.h.

Run "D."—In order to secure results as nearly as possible comparable with the conditions of voltage that will obtain in the actual operating zone, this run with six-car trains, similar to those used in run "C," was started at a point nearer the sub-station, near mile-post 164. For this run the electric locomotive, from the first turn of the wheels, accelerated more rapidly than the steam locomotive; and at a distance of 1,500 ft. from the starting-point, the electric locomotive led by a train length. The diagram in Fig. 265 shows the acceleration and speed-time curves for this run.

Run "E."—This run was made with the electric locomotive and one coach, and a maximum speed of 79 miles per hour was attained.

Run "F."—This run was made with the electric locomotive running light and with the power shut off on curves. A maximum speed of 80.2 miles per hour was attained. Had it not been necessary to shut off the current on curves, it is believed that the locomotive would have attained a speed of over 90 miles per hour in this comparatively short run. (A speed test on May 1st reached 85 miles per hour, with a limitation on the 2-degree 17-minute curve of 78 miles per hour.)

Riding Qualities.

At all speeds the smooth riding qualities of the electric locomotive were very noticeable, especially the lack of "nosing" effects. After the runs the track was carefully examined, and no tendency to spread rails was discovered. However, on the sharper curves the high speeds caused the track to shift bodily in the ballast, due to insufficient superelevation of the outer rail.

LOCOMOTIVES AND MOTOR CARRIAGES

Summary.

The most important test is run "D," as the voltage during that test more nearly approached the conditions that will be obtained in the electric zone. Therefore the comparison of steam and electric locomotives, given in Table XCIV., and based upon the results of run "D," are very interesting as illustrating the marked superiority in

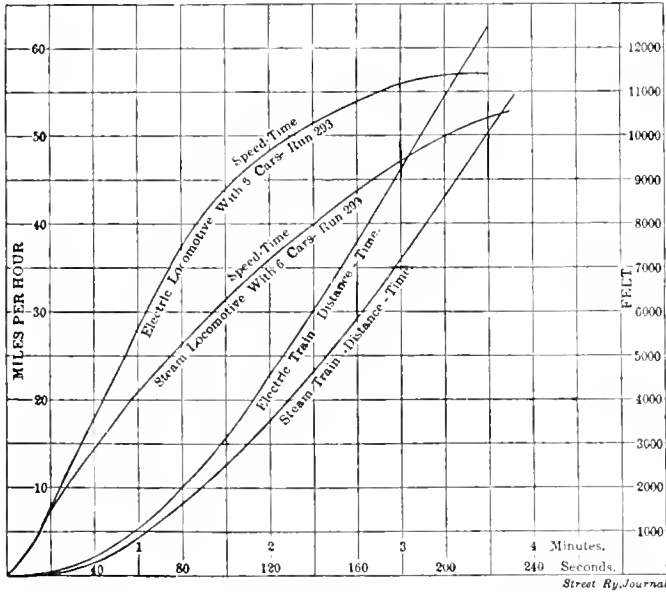

Fig. 265. ACCELERATION AND SPEED-TIME CURVES FOR RUN D OF NEW YORK CENTRAL LOCOMOTIVE TESTS.

acceleration of the electric locomotive over the steam locomotive. This is clearly the case, since the "Pacific" type of steam locomotive has practically the same weight upon the drivers.

TABLE XCIV.

Comparison of Steam and Electric Locomotives on New York Central Railway.

	Steam.	Electric.	Difference in favour of Electric.
Length over all	67 ft. 7 $\frac{3}{4}$ ins.	36 ft. 11 $\frac{1}{4}$ ins.	30 ft. 8 $\frac{1}{2}$ ins.
Total weight (including tender for steam locomotive)	342,000 lbs.	200,500 lbs.	141,500 lbs.
Concentrated weight on each driving axle	47,000 "	35,500 "	11,500 "
Revenue-bearing load back of locomotive	232 tons.	279 tons.	47 tons.
Acceleration m.p.h.p.s. averaging up to 50 m.p.h.	0.246	0.394	0.148
Time required to reach speed of 50 m.p.h.	203 seconds.	127 seconds.	76 seconds.

New York Central Locomotive Tests of September 7th, 1905.

These tests were carried out with the electric locomotive hauling a train of eleven cars, the first of which was a dynamometer car. The curves in Fig. 266 show the

ELECTRIC RAILWAY ENGINEERING

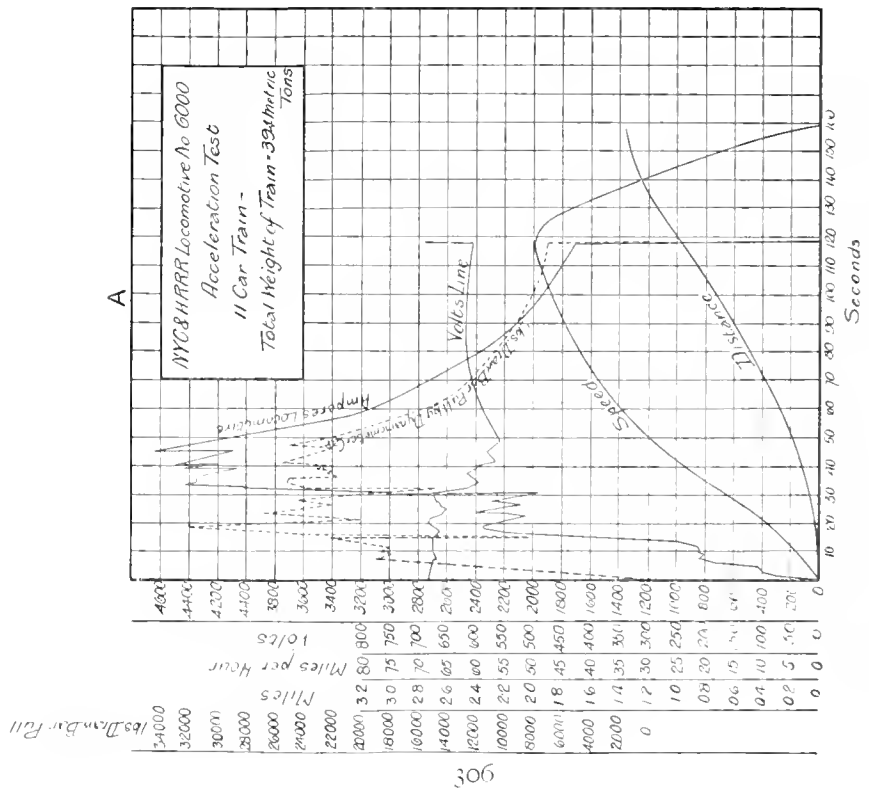

Fig. 266. ACCELERATION TEST ON NEW YORK CENTRAL ELECTRIC LOCOMOTIVE HAULING A TRAIN OF ELEVEN CARS.

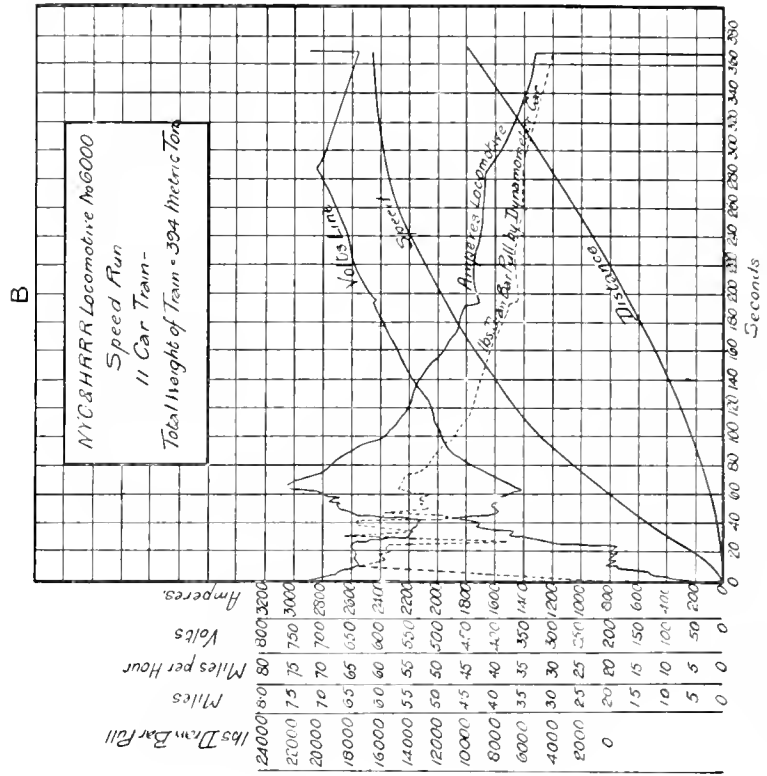

Fig. 267. SPEED RUN OF NEW YORK CENTRAL ELECTRIC LOCOMOTIVE HAULING A TRAIN OF ELEVEN CARS.

LOCOMOTIVES AND MOTOR CARRIAGES

results obtained on an acceleration test. All the records were taken on automatic recording instruments.

The draw-bar curve was taken on the dynamometer car, with unclamped recording pointer. The shape of this curve shows the much steadier pull of the electric locomotive as compared to that of the steam locomotive.

The weight behind the electric locomotive was 305 metric tons, and the weight of the complete train, including locomotive, was 394 metric tons.

The results for a run over a much greater distance ($4\frac{1}{2}$ miles), are plotted in the curves of Fig. 267.

Completion of 100,000 miles Endurance Test on New York Central Locomotive, No. 6,000.

In October, 1905, the first half of the 50,000 mile endurance run of the first high speed electric locomotive, built jointly by the General Electric Company and American Locomotive Company, was completed on the test tracks of the New York Central lines in Schenectady. On June 12th this locomotive completed the second half of this exhaustive service test. The maintenance expense per mile for the complete 50,000 mile run amounted to less than seven-tenths of a penny. This figure includes all maintenance expense on motors, brake shoes, tyres, inspection, and other miscellaneous items. Moreover, the operating conditions were much more severe than those to which the thirty-five electric locomotives, which have been ordered, will be subjected. The test locomotive hauled a train averaging 200 to 400 tons over a six mile track, and high speed running under these conditions involved higher braking and accelerating duty than in regular operating service.

According to a statement appearing in the technical press in August, 1906, eight of the thirty-five 100-ton 2,200 h.-p. electric locomotives which the manufacturers have built for the New York Central Lines, follow the same design as the locomotive No. 6,000, which has made this satisfactory record. There are in all fourteen machines now complete. Of the eight locomotives noted, two have been shipped to New York. The remaining locomotives are well under way at the shops of the General Electric Company and the American Locomotive Works, and it is expected that the complete number, thirty-five, will be ready for service early in October, 1906.

THE BALTIMORE AND OHIO 1896 GEARLESS LOCOMOTIVES.

While the New York Central electric locomotives for express passenger trains are the most powerful in the world, largely in virtue of their high speed, they just fall short of being the heaviest electric locomotives. The heaviest are the slow-speed locomotives employed for hauling freight and passenger trains through the Baltimore Belt Line Tunnel of the Baltimore and Ohio Railway. The earliest type of electric locomotive employed by the Baltimore and Ohio Railway is illustrated in Fig. 268 and weighs 87 metric tons. These locomotives, three of which were placed in service in 1896, are each capable of hauling 2,300-ton freight trains at a speed of 10 miles per hour. An 1,800-ton train has been hauled at 12 miles per hour, and a 500-ton train at 35 miles per hour. The 1896 Baltimore and Ohio locomotive, like the New York Central locomotive, has gearless motors, but these have six poles, whereas the New York Central motors are bipolar. These 87-ton Baltimore and Ohio locomotives of 1896

LOCOMOTIVES AND MOTOR CARRIAGES

TABLE XCV.—*continued.*

Total tractive effort at starting, assuming 25 per cent. tractive coefficient, 48,000 lbs.

Gauge, 4 ft. 8½ ins.

Diameter of driving wheel, 62 ins.

Length of locomotive over all, 35 ft.

Extreme width, 9 ft. 5 in.

Height to top of cab, 13 ft. 11¾ ins.

Total wheel base, about 23 ft.

Wheel base of each truck, 6 ft. 10 ins.

Motor axle (sleeve) bearings, 7¼ ins. × 13 ins. diameter.

Journal bearings, 8¾ ins. × 6 ins. diameter.

Owing to the low speed required, the motors were permanently connected two in series, so that in accelerating the transition was from all four motors in series to two

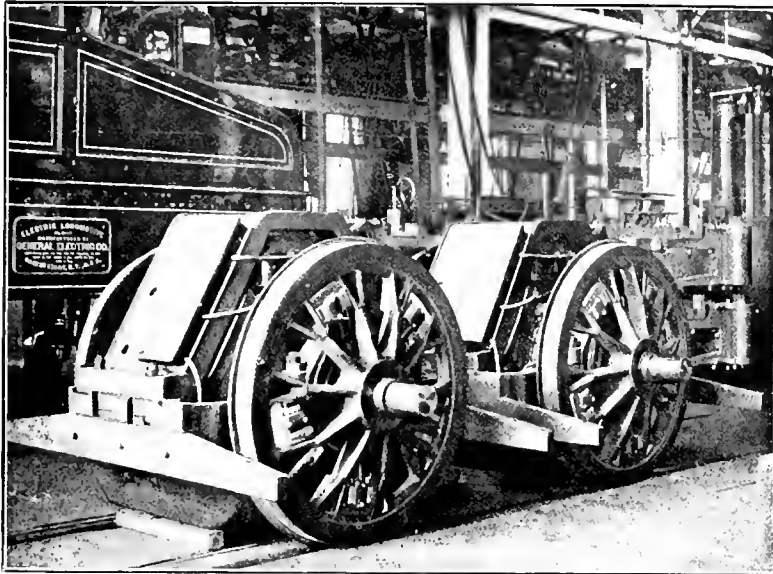

Fig. 268A. TRUCK OF BALTIMORE AND OHIO 1896 GEARLESS LOCOMOTIVE, SHOWING MOTOR IN PLACE.

parallel pairs in series. This method of running the motors gave to the locomotive an aggregate nominal rating of 720 h.-p.

As originally installed, these locomotives were designed to take power from a trolley at an average pressure of about 625 volts. Due to changes in the conditions of operation, it was later found more economical to adopt a third-rail system.

The original tests made after these three locomotives had been put into service in 1896 exceeded the most sanguine expectations which had been formed at that comparatively early date. It was found that one locomotive could accelerate a loaded train equivalent to fifty-two freight cars having a total weight of 1,900 tons. This acceleration was accomplished smoothly on a grade of 0.8 of 1 per cent., and the train finally brought up to a speed of 12 miles per hour. The draw-bar pull exerted during

ELECTRIC RAILWAY ENGINEERING

acceleration was 63,000 lbs., and the current taken by the locomotive from the line at 625 volts was 2,200 amperes during acceleration, steadying down at constant speed to 1,800 amperes.

Applying to this data the rule that a tractive force of 100 lbs. per ton produces an acceleration of 1 m.p.h. per second, and allowing for the up-grade of 0.8 of 1 per cent., we have :—

$$\text{Total tractive force} = \frac{63,000}{1,900} = 33.2 \text{ lbs. per ton.}$$

$$\text{Tractive force for 0.8 per cent. grade} = 0.8 \times 22 = 17.6 \text{ lbs. per ton.}$$

$$\text{Accelerating tractive force} = 33.2 - 17.6 = 15.6 \text{ lbs. per ton.}$$

$$\text{Rate of acceleration} = 0.156 \text{ m.p.h. per second.}$$

$$\text{Time required to obtain a speed of 12 m.p.h.} = \frac{12}{0.156} = 77 \text{ seconds.}$$

$$\text{Output during acceleration} = \frac{2,200 \times 625}{1,000} = 1,380 \text{ k.w.}$$

$$\text{Energy consumed during acceleration} = \frac{1,380 \times 72}{3,600} = 29.5 \text{ k.w.h.}$$

One of the trucks of an 1896 Baltimore and Ohio locomotive is shown in Fig. 268A.

The Baltimore and Ohio 1903 Geared Locomotives.

Two new two-unit locomotives weighing 146 tons per pair (or 73 tons per individual locomotive) have recently been supplied to the Baltimore and Ohio road. A unit of

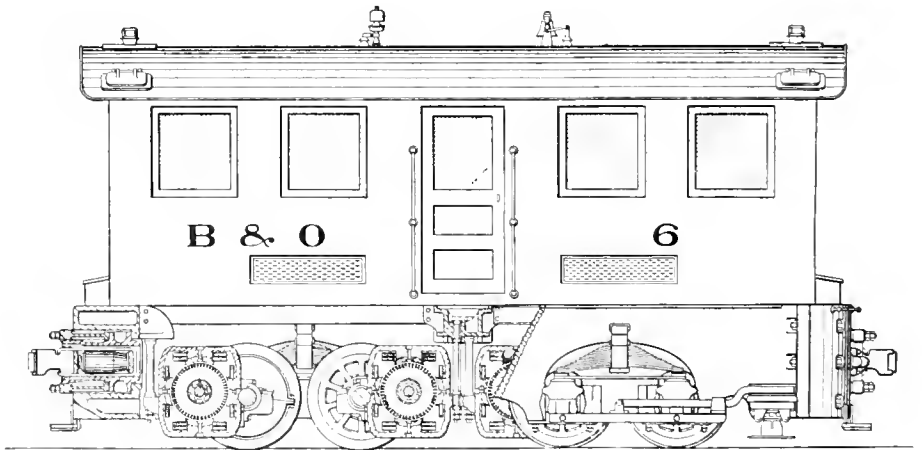

Fig. 269. ONE COMPONENT OF 1903 BALTIMORE AND OHIO LOCOMOTIVE.

one of these is illustrated in Fig. 269, while Fig. 270 shows a photograph of a complete two-unit set. Fig. 271 shows an interior view; Fig. 272 is a photograph of the frame.

Each individual locomotive is equipped with four 200 nominal h.-p., four-pole, geared, one-turn, G.E. 65 B. motors, or about 1,600 nominal h.-p. for the complete double locomotive with eight motors. The ratio of gearing is 81 : 19, or 4.26.

LOCOMOTIVES AND MOTOR CARRIAGES

It was specified that this two-unit locomotive should handle a train of a weight of 1,450 metric tons, exclusive of the weight of the locomotive itself, on the Baltimore and Ohio Trunk Line through the tunnel over a $1\frac{1}{2}$ per cent. grade, at a speed of 9 miles per hour on a 625-volt circuit.

Assuming an accelerating rate of 0.25 m.p.h. per second, a tractive force of 25 lbs. per ton would be required for acceleration. A further tractive force of 33 lbs. per ton would be required for the $1\frac{1}{2}$ per cent. grade. This gives a total tractive force of $25 + 33 = 58$ lbs. per ton, or $58 \times 1,450 = 84,000$ lbs. for the entire 1,450 tons. Adding the weight of the 2-unit locomotive (146 tons), gives a tractive force from the motors of $\frac{1,450 + 146}{1,450} \times 84,000 = 92,000$ lbs.

The controlling apparatus consists of a multiple-unit control system so arranged as to be able to operate each section independently, or two or more sections coupled

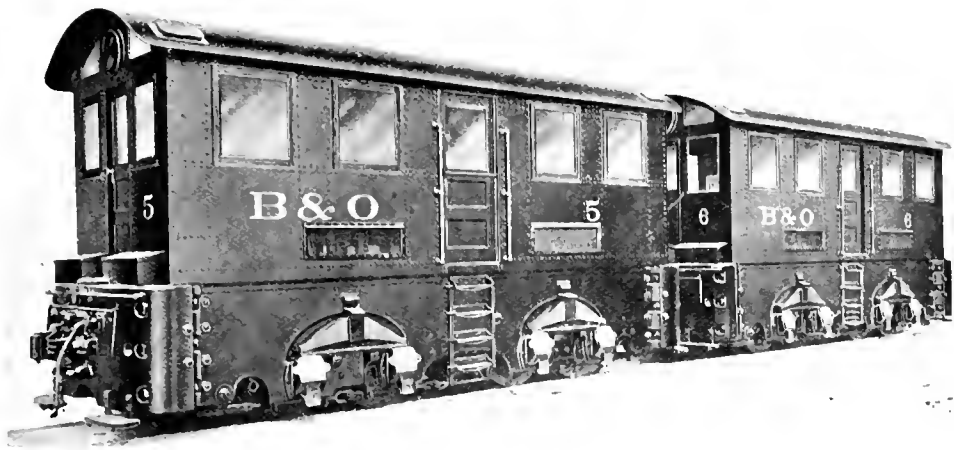

Fig. 270. BALTIMORE AND OHIO TWO-UNIT 1903 LOCOMOTIVE, WITH GEARED FOUR-POLE MOTORS.
WEIGHT OF TWO-UNIT COMBINATION, 146 TONS.

together. The cab is of the box type. The master controllers, driver's valves, etc., are in duplicate, a complete set being located in diagonally opposite corners of each cab, so that the driver can, when it best serves the purpose, operate from whichever end of the locomotive corresponds to the direction of motion.

Glass doors and windows furnish an unobstructed view of the track and surroundings in all directions. There is also a large space under the cab floor to facilitate inspection of the motors and truck gear.

The main body of the truck frame consists of a rectangular framework of cast steel, made up of four heavy pieces, two side frames and two end frames. The parts are machined at the ends and securely fitted and bolted together, thus forming a strong and rigid structure capable of withstanding severe shocks without injury. The end pieces form the buffer beams, and to these is attached a draft gear of approved design which will withstand a maximum tractive force of 100,000 lbs. The draft gear permits of both longitudinal and lateral motion. The truck frames are supported at four

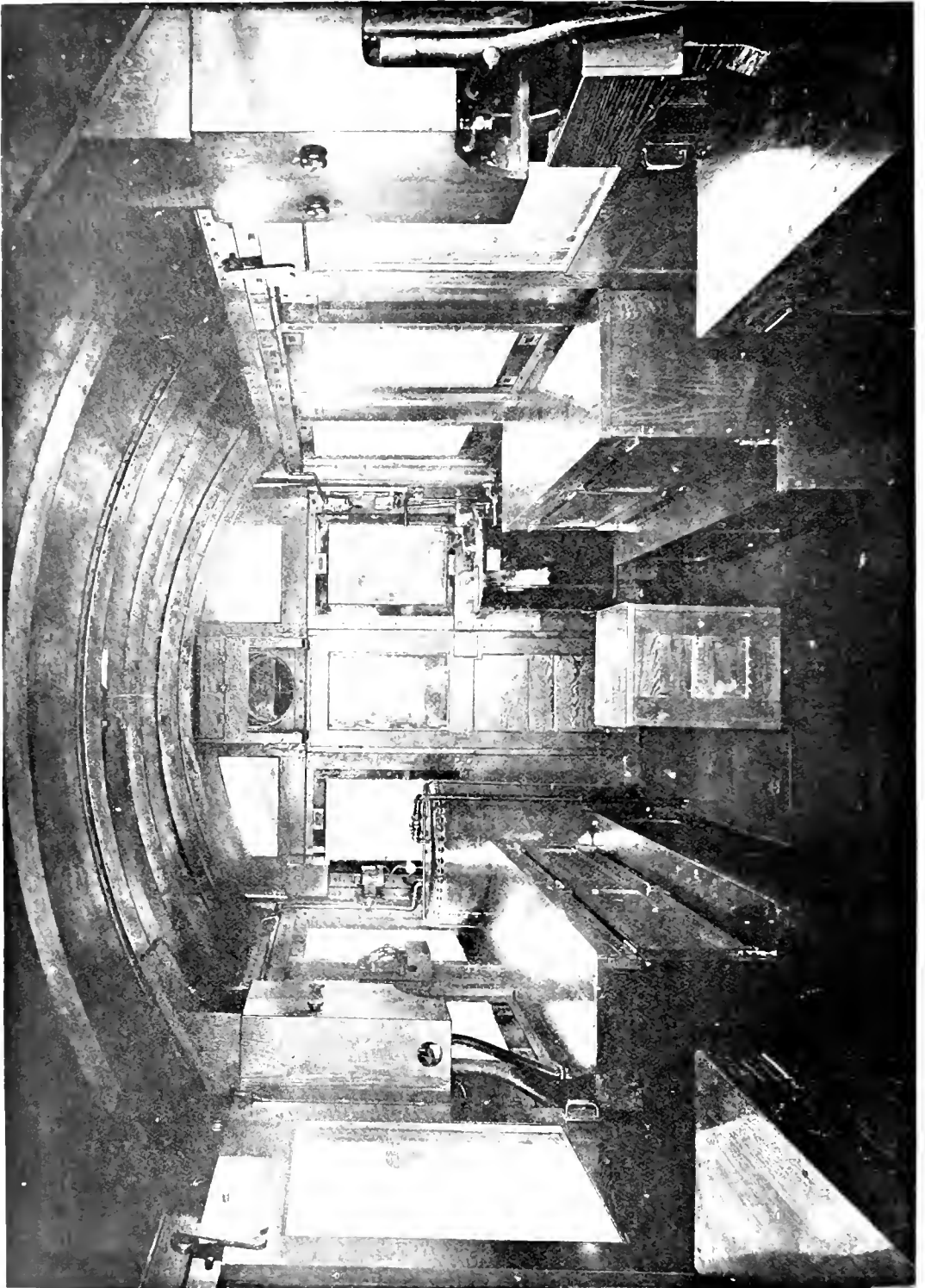

Fig. 271. INTERIOR OF ONE-UNIT OF BALTIMORE AND OHIO 1903 ELECTRIC LOCOMOTIVE.

LOCOMOTIVES AND MOTOR CARRIAGES

points on equalisers. Each equaliser rests on half-elliptic springs, the ends of which rest on the journal boxes. In construction, the journal boxes are similar to those used in standard railway practice, except that they are larger and stronger. The brasses

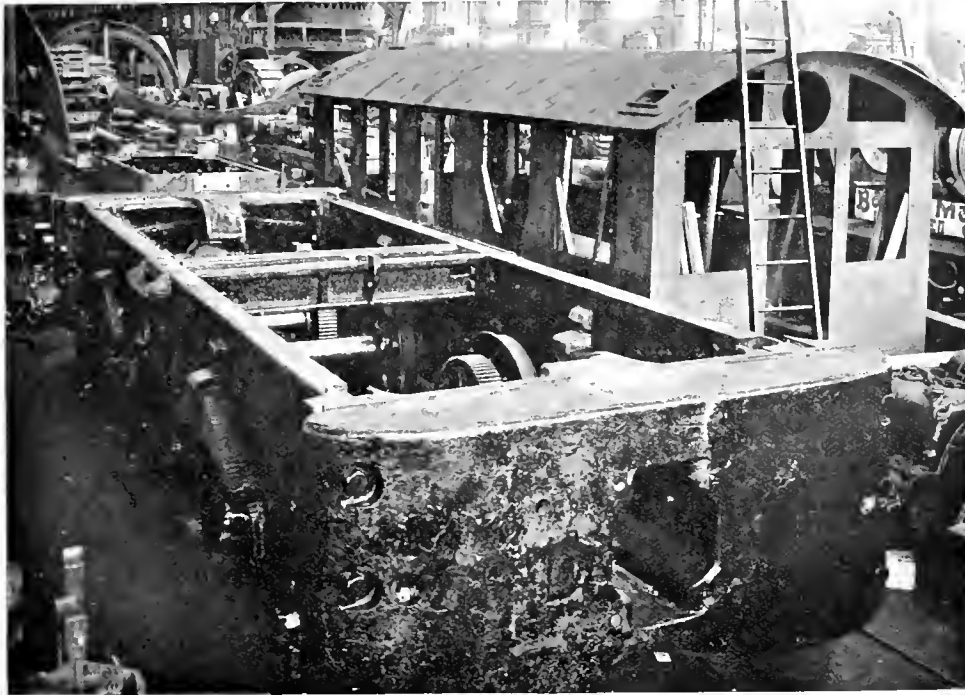

Fig. 272. FRAME OF ONE-UNIT OF BALTIMORE AND OHIO 1903 ELECTRIC LOCOMOTIVE.

may readily be removed without moving the wheels and axles or other parts of the truck.

The principal dimensions of the locomotive are given in Table XCVI.

TABLE XCVI.

Principal Dimensions of Baltimore and Ohio 1903 Geared Two-unit Locomotive.

Weight of locomotive	146 metric tons (73 metric tons per unit)
Number of units	2
Type of motor	G.E. 65 B
Horse-power rating of each motor	200 h.-p. at 625 volts
Gearing ratio	$81/19 = 4.26$.
Rigid frame.	
Number of motors (4 per unit)	8
Number of driving wheels (8 per unit)	16

ELECTRIC RAILWAY ENGINEERING

TABLE XCVI.—*continued.*

Principal Dimensions of Baltimore and Ohio 1903 Geared Two-unit Locomotive—continued.

Weight on driving wheels (73 metric tons per unit)	146 tons
Total tractive effort for two units at full load on motors	70,000 lbs.
.. .. . at starting up, assuming 25 per cent. tractive coefficient	80,000 lbs.
Gauge	4 ft. 8½ ins.
Diameter of driving wheels	42 ins.
Length over all (for one unit, 29 ft. 7 ins.)	58 ft. 7½ ins.
Wheel base of each unit	14 ft. 6¾ ins.
Extreme width (over cab roof)	9 ft. 5½ ins.
Width to outside of third rail shoe supports	10 ft. 7½ ins.
Height to top of cab	13 ft. 8 ins.
.. .. . of bell	14 ft. 9¼ ins.
Motor axle bearings	14 ins. × 8 ins. diameter
Journal bearings	12 ins. × 6 ins. diameter

The weight of the electrical equipment per component unit, is made up as shown in Table XCVII.

TABLE XCVII.

Weight of Electrical Equipment of Baltimore and Ohio 1903 Geared Two-unit Locomotive.

Four motors, each weighing 8,855 lbs., complete with gear and case	35,420 lbs.
Weight of twenty-three rheostats	2,760 ..
Weight of two master controllers	496 ..
Weight of complete control apparatus, including master controllers and rheostats	5,710 ..
Weight of air compressor	1,600 ..
Weight of cables and miscellaneous accessories	2,000 ..

Total weight of electrical equipment 44,730 lbs.,
 or 20.4 metric tons, or **28 per cent. of the total weight per unit.**

The locomotive carries the customary whistle, bell, head-lights, improved air brake mechanism, pneumatic track sander, air compressor couplers, and draw-heads.

In order to convey some idea of the relative size of these locomotives it may be noted that at the nominal rating of the motors, each locomotive is capable of accelerating on a level a train weighing 3,000 tons with a current consumption of 2,200 amperes. At a speed of 13 miles per hour this current steadies down to 900 amperes. With the same current of 2,200 amperes the locomotive will accelerate a 1,400-ton train to a speed of 10 miles per hour on a 1 per cent. grade, the current at this speed being 1,600 amperes. The free running speed of the locomotive, without train, is approximately 24 miles per hour.

LOCOMOTIVES AND MOTOR CARRIAGES

In Fig. 273 are given the tractive force and speed curves for one of these two-unit locomotives when all eight motors are connected in parallel, as published in 1904

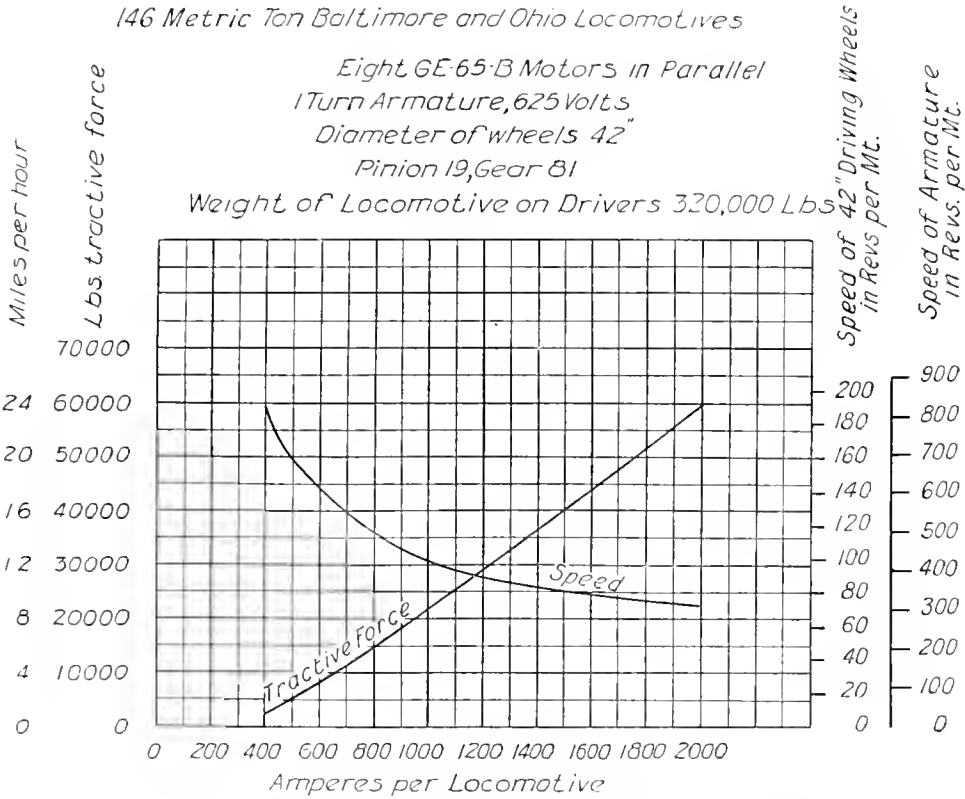

Fig. 273. CHARACTER CURVES OF BALTIMORE AND OHIO 1903 GEARED TWO-UNIT LOCOMOTIVE.

by the General Electric Co. of America and presumably calculated from factory tests of the motors.

GEARED versus GEARLESS LOCOMOTIVES.

The question of geared *versus* gearless motors for locomotives is one of considerable importance. In the first passenger locomotives employed on the City and South London Railway, gearless motors were installed, and are still almost exclusively employed on this road, the only geared locomotive being kept as a spare, and employed in shunting. In the locomotives used on this road, the armature is built up directly on the axles, as shown in Fig. 274, and no provision is made for protecting it against the blows transmitted through the wheels from the track. Mr. P. V. McMahon, the Chief Engineer of the City and South London Railway, nevertheless reports¹ that "although troubles have been experienced with these locomotives, principally due to failures of armature winding, they have run upwards of 400,000 miles in actual service." The average life of the armature works out at "over 100,000 miles before rewinding, and experience shows that in no case can the armature failures be traced to having the armatures

¹ *Cassier's Magazine*, August, 1899, p. 535.

ELECTRIC RAILWAY ENGINEERING

directly secured to the axle of the locomotive." Mr. McMahon states that in the case of the only geared locomotive employed on the road, armature troubles are just as

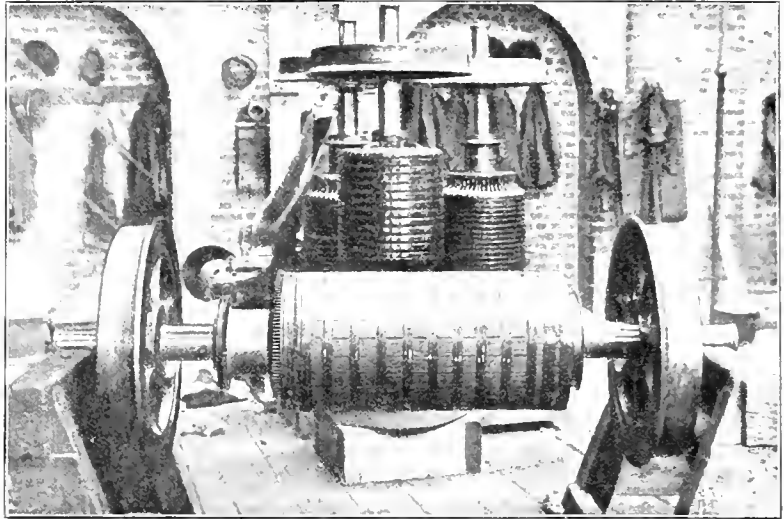

Fig. 274. METHOD OF MOUNTING ARMATURE ON AXLE OF CITY AND SOUTH LONDON RAILWAY GEARLESS LOCOMOTIVE.

frequent as with the geared locomotives, "and the gearing makes such a noise that this locomotive is kept as a spare one and is used for shunting." The City and South



Fig. 275. CITY AND SOUTH LONDON GEARLESS LOCOMOTIVE.

LOCOMOTIVES AND MOTOR CARRIAGES

London locomotives have been supplied by various firms. The type supplied by Messrs. Siemens Bros. is illustrated in Fig. 275.

As already stated, the earlier Baltimore and Ohio locomotives are equipped with gearless motors. The armatures are carried on sleeves, on the ends of which spiders are shrunk, and the driving wheels are rotated by the spider arms which project between the spokes and are provided with double rubber cushions. This construction has been illustrated in Fig. 268A, on p. 309, which represents a truck of one of these locomotives with the gearless motors in place.

The Central London Railway Locomotives.

The Central London locomotives, outline drawings of one of which are given in Fig. 276, were each equipped with four gearless motors, of the G.E. 56 type. These were supplied as of 117 h.-p. each, but, in accordance with the standard 1-hour method of rating, they could more properly be estimated as of 170 h.-p. nominal capacity each. For these motors, the armature cores were built up on sleeves, which were pressed directly upon the shaft. These moderately heavy locomotives (each weighed 44 metric tons), occasioned vibrations in the buildings above the tube in which they operated, and a geared and consequently lighter locomotive was tried. The geared locomotive was equipped with four 150 nominal h.-p. motors (of the G.E. 55 A. type), the ratio of gearing being 3:3 : 1. The weight of this geared locomotive was only 31½ tons, or 72 per cent. of the weight of the gearless locomotive. There still being some vibration, however, locomotives were altogether abandoned, and the road is now operated exclusively with a service of trains each consisting of five trailers at the middle of the train and a motor car at each end, the end truck of each motor car carrying two 125 h.-p. motors of the G.E. 66 A. type, with a ratio of gearing of 3:9 : 1.

In Table XCVIII. are given the detailed weights of the gearless Central London Railway locomotive:—

TABLE XCVIII.

Detailed Weights of Gearless Central London Railway Locomotive.

Description of Part.	Weight in Pounds.	
	Each.	Total.
Platform frame		10,600
Cab with sloping ends		2,770
Two trucks without motor, wheels, and axles	9,435	18,870
Four motor armatures, less shaft	3,000	12,000
Four motor fields	9,000	36,000
One controller		1,808
Thirty P.R. resistance boxes	100	3,000
One C.P. 10 air-pump (with motor)		1,280
One air receiver (included in locomotive frame)		
Small electrical accessories, say		200
Motor connections		115
Brushes		76
Eight wheels	975	7,800
Four axles	760	3,040
Total pounds		97,559,
		or 44½ metric tons.

LOCOMOTIVES AND MOTOR CARRIAGES

The weights of the component parts of the locomotive, excluding electrical equipment, are given in Table XCIX.

TABLE XCIX.

Gearless Central London Locomotive Weights, Exclusive of Electrical Equipment.

Description of Part.	Weight in Pounds.	
	Each.	Total.
Platform frame		10,600
Cab with sloping ends		2,770
Two trucks without motor, wheels, and axles	9,435	18,870
Eight wheels	975	7,800
Four axles	760	3,040
Total pounds		43,080,
		or 19·6 metric tons.

The weights of the electrical equipment are given in Table C.

TABLE C.

Weights of Electrical Equipment of Gearless Central London Locomotive.

Description of Part.	Weight in Pounds.
Motor armatures	12,000
Motor fields	36,000
Controller (L.7)	1,800
Pressed ribbon resistances	3,000
Air compressor set	1,300
Small electrical accessories	200
Motor connections and brushes	200
Total weight electrical equipment	54,500, or
	25 metric tons, or 56 per cent. of total weight of locomotive.

Paris-Orleans Locomotives.

In Figs. 277 and 278 is illustrated a 49 metric ton¹ geared locomotive, somewhat larger than the Central London geared locomotive, but of the same general type. Eight locomotives of this design were, in 1900, placed in service on the lines of the Chemin de Fer de Paris-Orleans to haul 300-ton passenger trains from the Austerlitz Station through 2·4 miles of tunnel to the new terminus near the Quai d'Orsay. Most of the trains made an intermediate stop of 1 minute's duration at Pont St. Michel. The running time over these 2·4 miles, including the intermediate stop, was 8 minutes, or a schedule speed of 18 miles per hour. The express service required only 7 minutes, which corresponds to 20·5 miles per hour. Each locomotive was

¹ The weight of the locomotive has often been quoted at 100,000 lbs., or 45 metric tons. The true figure is, however, 49 metric tons.

ELECTRIC RAILWAY ENGINEERING

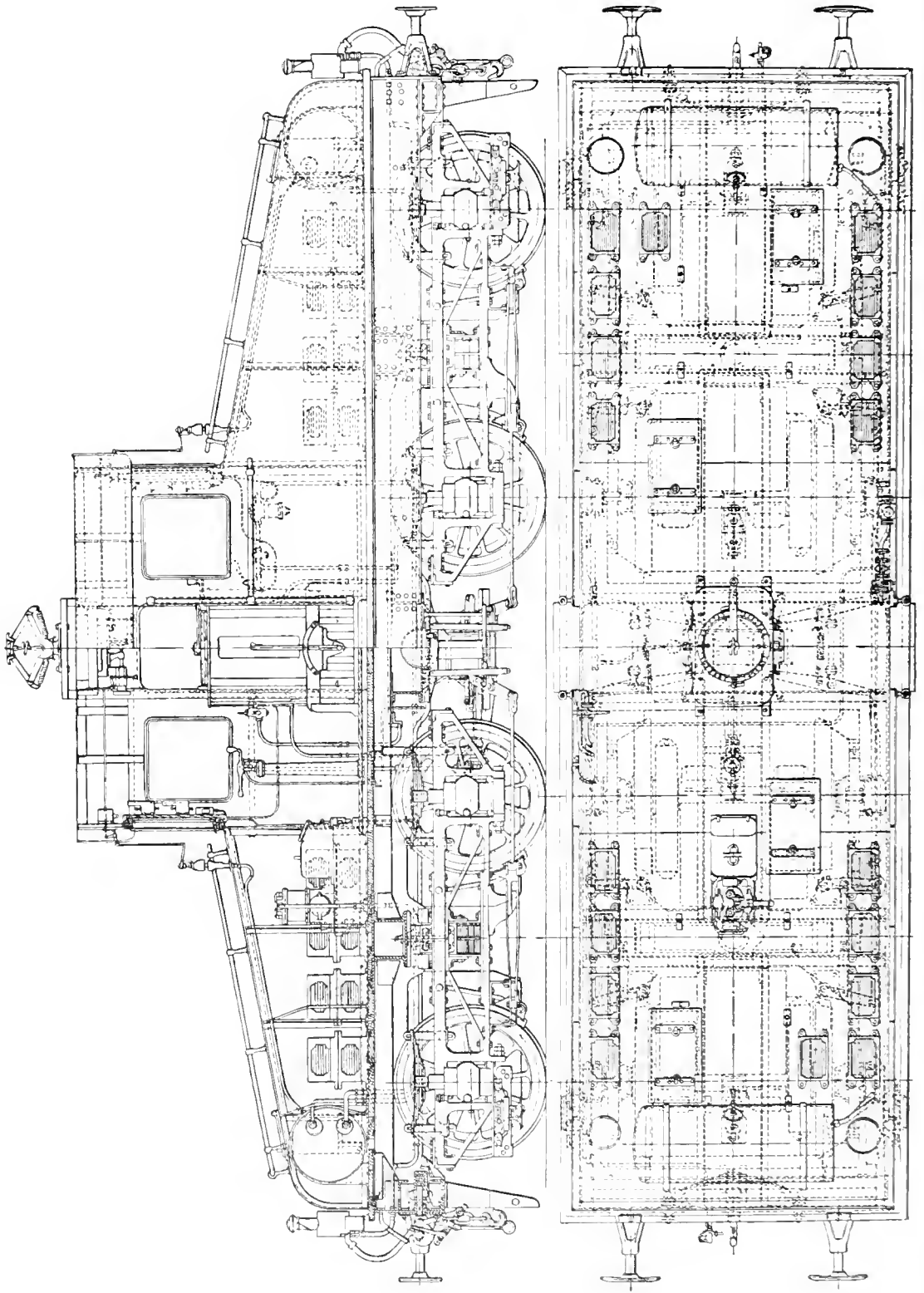

FIG. 277. 49 METRIC-TON PARIS-ORLEANS GEARED ELECTRIC LOCOMOTIVE.

LOCOMOTIVES AND MOTOR CARRIAGES

equipped with four geared 250 h.-p.¹ motors of the G.E. 65 A. type, one on each axle of the two bogie trucks, or 1,000 h.-p. per locomotive.

The design of the locomotive consists of a central steel cab with sloping ends mounted on a channel framework and carried by two swivel trucks. The trucks are of especially

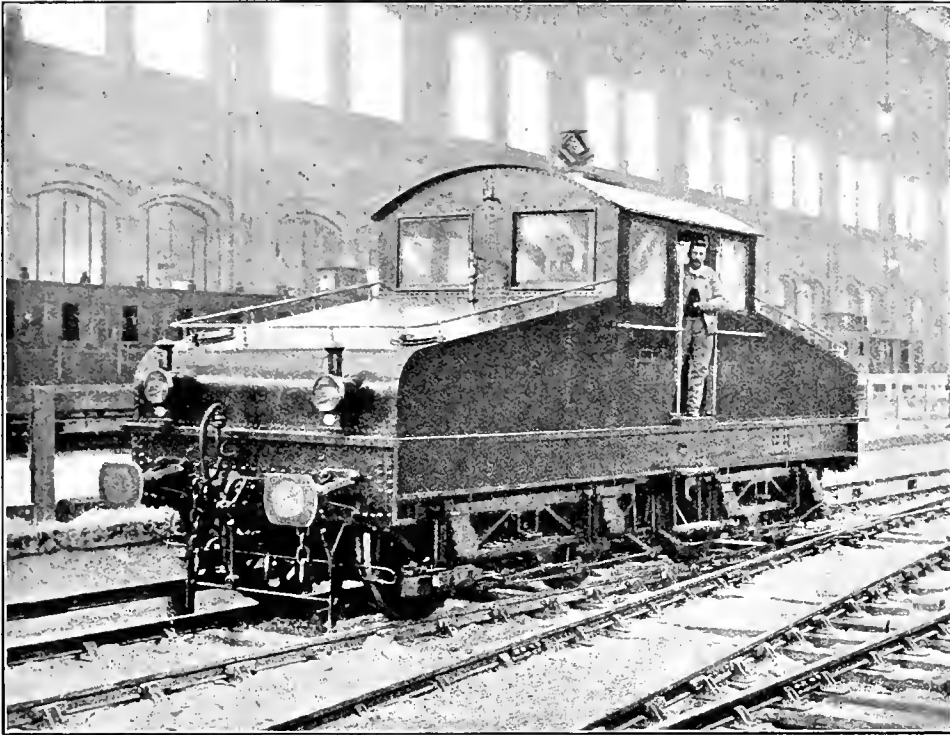

Fig. 278. PARIS-ORLEANS GEARED ELECTRIC LOCOMOTIVE.

heavy build, being constructed with solid forged-steel side frames after the manner of steam locomotive construction, and in contrast with the common M.C.B. type. The general appearance of the locomotive is clearly shown in Figs. 277 and 278, and the principal data are set forth in Table CI.

TABLE CI.

Principal Data of Paris-Orleans Geared Electric Locomotives.

Length over all	34 ft. 10 ins.
Width „ „	9 „ 7 „
Height above rails	12 „ 9 „
Distance between trunk centres	16 „ 0 „
Wheel base, each truck	7 „ 10 „
„ „ total	23 „ 10 „
Diameter drivers	4 „ 1 „
Central cab length	9 „ 10 „
„ „ width	8 „ 11 „
Number of driving wheels	8
Total weight of locomotive	49 metric tons.

¹ These motors have been referred to as of 225 h.-p., and also as of 270 h.-p. We have, therefore, taken them as being of 250 h.-p. capacity on the 1-hour basis of rating.

ELECTRIC RAILWAY ENGINEERING

The truck side frames are carried on half-elliptic springs over each axle-box, the arch of the spring (which is inverted) resting on top of the axle-box, and the ends of the springs supporting the side frames by means of links. The bolster is supported on regular double elliptic springs carried in the transom.

The motors are of the single reduction railway type, and are supported by nose suspension on a lip carried by the truck transom. The gear ratio is 78 to 19 (4.1 to 1), and the axle brackets surround an axle 7 ins. in diameter,

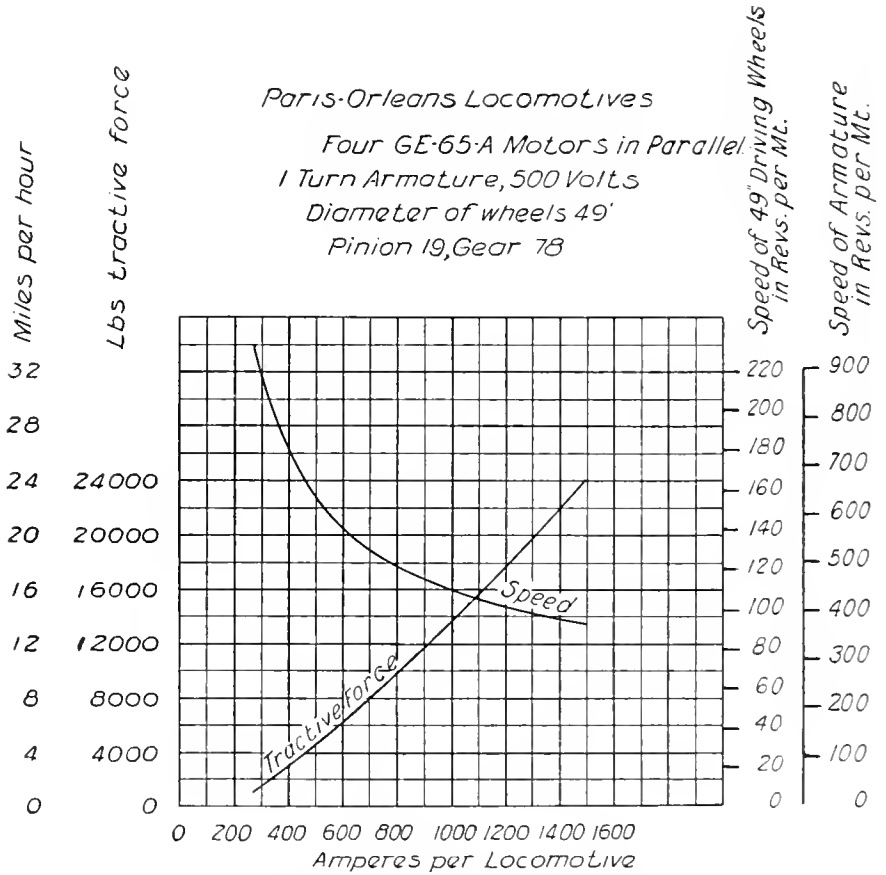

Fig. 279. CHARACTERISTIC CURVES OF PARIS-ORLEANS LOCOMOTIVE, WITH 4.1 GEAR RATIO.

the size of the axle being 7.5 ins. in the gear fit and 6 ins. in the journals, which are 10 ins. long. The controller is of the L. 7 series parallel type, and is operated in conjunction with rheostats located in the sloping cab ends. The air brakes are of the Wenger compressed air system, the supply being furnished on each locomotive by a pair of C.P.-10 compressors, each having a rated piston displacement of 35 cubic ft. per minute against 90 lbs. per square inch. The track sanding device and the whistle are operated from the compressed air supply, which is maintained at constant pressure by means of an automatic governor operating in connection with the compressor motors. Included in

LOCOMOTIVES AND MOTOR CARRIAGES

the electrical equipment of the locomotive are also an ammeter, volt meter, and recording watt meter, together with a main circuit breaker, magnetic blow-out, main switch, and other accessories.

The third-rail system supplies current at 575 volts, and the locomotive is equipped with four shoes for making contact with the side running conductor. In certain portions of the route where the track work is difficult, the side rails are supplemented by short stretches of rail in the centre, for which the locomotive carries suitable additional contacts supported by insulated brackets on the motor frames. At still other points where undesirable complication in the third-rail arrangements has been experienced, the current is now fed to the locomotive by an overhead conductor of inverted T-iron, and the top of the cab is provided with a parallel motion shoe which comes into requisition at these points.

The weight of the electrical equipment is made up as shown in Table CII.

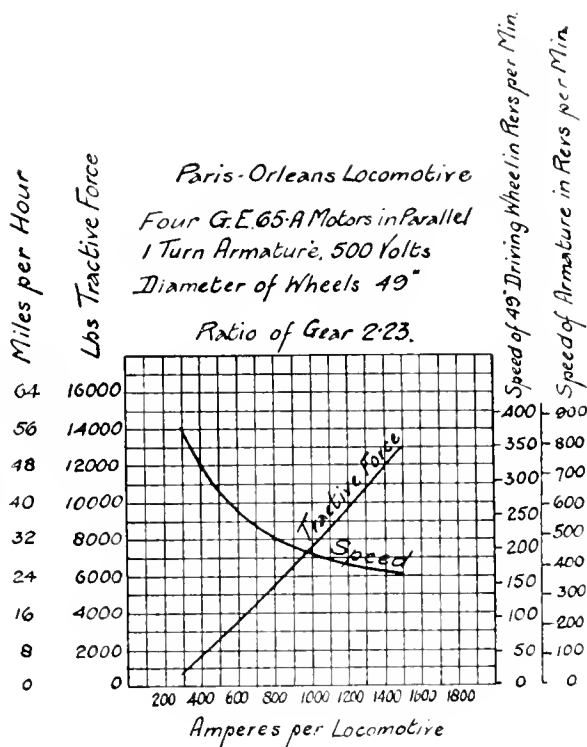

Fig. 280. CHARACTERISTIC CURVES OF PARIS-ORLEANS ELECTRIC LOCOMOTIVES WITH 2:23 GEAR RATIO.

TABLE CII.

Weights of Electrical Equipment of Paris-Orleans Geared Electric Locomotives.

Four G.E. 65 A. motors, including gear and gear case, at 8,930 lbs. each	35,700
Weight of rheostats per locomotive	3,000
Weight of controllers per locomotive	4,500
Weight of remainder of electric equipment	3,500

Total weight of electrical equipment of one locomotive, including motors, controllers, rheostats, gearing, air compressors, and instruments 46,700 lbs., or 21.0 metric tons, or 43 per cent. of total weight of locomotive.

The initial equipment furnished to the Orleans Co. comprised eight complete locomotives, each of which made an average total of over 18,000 locomotive miles per annum, the "crow-mileage" totalling for the same period about 10,500 locomotive miles.

The Paris-Orleans road has since 1900, when these eight electric locomotives were put in service on the 2.4-mile tunnel section, gradually carried out the electrification of other sections of the line. Chief among these is a 12-mile section between Austerlitz Station and Juvisy. This necessitated more rolling stock; and, in addition to securing three new locomotives and a number of motor cars, the company, in 1904,

ELECTRIC RAILWAY ENGINEERING

changed the gear ratio of seven of these eight original locomotives from 4·1 to 2·23, thus changing the characteristic curves from those shown in Fig. 279 to those of Fig. 280.

The three new locomotives are of the "baggage-car" type, as shown in Fig. 281. Each new locomotive is also equipped with four G.E. 65 motors with a gear ratio of 2·23, and therefore also has the characteristics shown by the curves of Fig. 280.

Denoting by E^1 that one of the eight original locomotives which still has the original gear ratio of 4·1, by E^2 to E^8 , those in which the ratio has been changed to 2·23, and by E^9 to E^{11} , the new locomotives of the "baggage car type," we obtain the

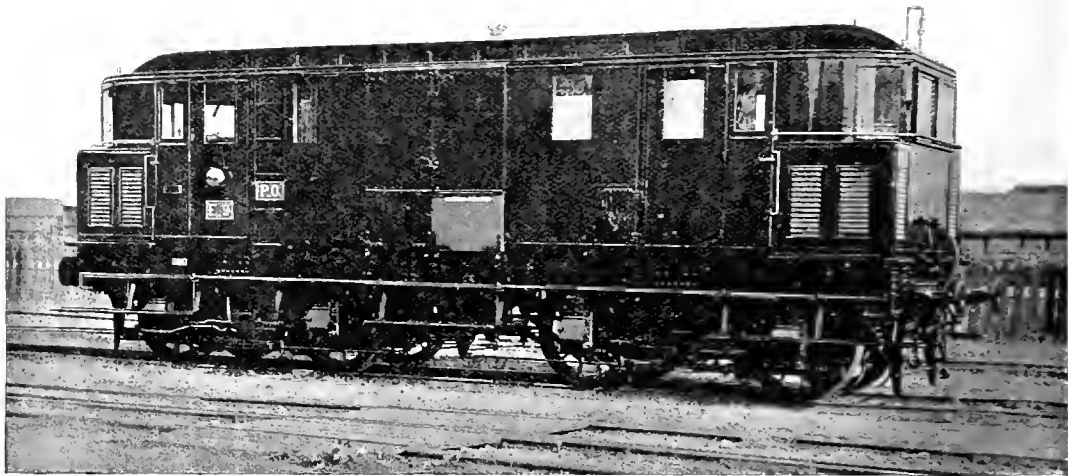

Fig. 281. "BAGGAGE CAR" TYPE OF PARIS-ORLEANS ELECTRIC LOCOMOTIVE.

leading data set forth in Table CIII. The figures in the last column, AE^1 to AE^5 , refer to five motor cars each equipped with four G.E. 66 motors. These motors each have a 1-hour rating of 125 h.-p.

TABLE CIII.

Data of Paris-Orleans Rolling Stock.

	Original Type (1900).		Baggage Car Type (1904).	Motor Cars.
	E^1 .	E^2 to E^8 .	E^9 to E^{11} .	AE^1 to AE^5 .
Weight	49 tons.	49 tons.	55 tons.	45 tons.
Length over all	34 ft. 10 ins.	34 ft. 10 ins.	37 ft. 6 ins.	57 ft. 0 ins.
Number of bogies	2	2	2	2
Wheel base, each truck	7 ft. 10 ins.	7 ft. 10 ins.	7 ft. 10 ins.	6 ft. 6 ins.
Distance between truck centres	16 ft. 0 ins.	16 ft. 0 ins.	18 ft. 6 ins.	40 ft. 8 ins.
Diameter drivers	4 ft. 1 in.	4 ft. 1 in.	4 ft. 1 in.	3 ft. 6 ins.
Ratio of gearing	4·1	2·23	2·23	3·08

LOCOMOTIVES AND MOTOR CARRIAGES

The locomotives with the 2:23 gearing, when running without a train, may attain a speed of 62 miles per hour, and will haul a 200-ton train at a speed of 43 miles per hour. Each locomotive is supplied with an extra controlling switch permitting of grouping the four motors either in two groups of two motors in series or in two groups of two motors in parallel. The main controller effects the series-parallel controlling of these two groups. The newest locomotive is furnished with multiple unit control apparatus, but the first ten locomotives have L. 7 controllers.

Two motor cars, each equipped with four G.E. 66 motors, when employed in a train of a total weight of 200 tons, cover the 12 miles from Austerlitz to Juvisy in 15 minutes without a stop. This is an average speed of 48 miles per hour from start to stop. Some still newer motor cars are furnished with G.E. 55 motors, and the first five motor cars will ultimately have their G.E. 66 motors replaced by G.E. 55 motors.

Gearless Locomotive especially adapted to Heavy Traction at High Speeds.

The contractors for the New York Central locomotives, in referring to this question of geared *versus* gearless locomotives, have stated that, in studying the conditions to be met by the New York Central locomotives, it was concluded that the gearless motor design possessed characteristics especially adapted to high speed electric traction work. For the specified service conditions it was thought to be superior to any geared motor which it was possible to build. In working out the design, the endeavour was to secure great simplicity, strength, ease of inspection, and facility in making repairs. The absence of motor bearings and gears and the excellent commutation and heating qualities of the motors are stated to ensure minimum maintenance charges. In making repairs or renewals, an armature, with its wheels and axle, may be removed by lowering the complete element without disturbing the fields or any other part of the locomotive, and a new element inserted in its place. The design overcomes the great difficulty of providing a sufficiently small clearance between pole shoes and armature surface, and at the same time permits sufficient flexibility of support to the magnet frame to prevent unduly severe blows on the track. By the choice of a two-pole construction, a large vertical movement of the spring-borne frame does not materially affect the depth of the air gaps. In the design of the New York Central locomotive, the dead weight on the axle is not materially greater than is customary with locomotives, and, furthermore, there is no unbalanced weight to produce vibration, with attendant injury to the track and road-bed construction. Table CIV. was prepared in this connection to show the estimated total dead weight per axle of the electric locomotive shown in Fig. 252, as compared with representative steam locomotives of equal capacity:—

TABLE CIV.

Comparison of Steam Locomotive with Gearless Bi-polar Electric Locomotive.

	Total Weight of Driving Wheels— Pounds.	Diameter Driving Wheels.	Total Dead Weight per Axle—Pounds.	Unbalanced Dead Weight per Axle—Pounds.
Steam locomotive	131,000	51 ins.	7,000 to 11,000	122 to 129
” ”	127,500	70 ins.	10,000 to 13,000	77 to 81
Electric locomotive of Fig. 252	133,000	44 ins.	12,000	0

ELECTRIC RAILWAY ENGINEERING

Advantages Associated with the Greater Weight of Gearless Locomotives.— Adhesive Coefficients.

Furthermore, the use of gearless motors on locomotives is often of distinct advantage in giving the weight per axle necessary for securing sufficient adhesion in starting heavy loads. In some cases, where geared motors are used on electric locomotives, it has either been the practice to adopt an especially heavy truck construction or to load the locomotive with ballast. It must, however, be borne in mind that, owing to the exceedingly uniform effort imparted to the driving wheels by the rotative motion of the armature as compared with the varying thrust of a steam locomotive, an electric locomotive of a given weight can exert a greater tractive force before slipping the wheels than can a steam locomotive. It is on record that the 87-ton gearless Baltimore and Ohio locomotive has started from rest a 1,700-ton train against such a grade as to require the development of a tractive force of 63,000 lbs. behind the locomotive, which thus developed a tractive force of 720 lbs. per ton of weight. This is a tractive force equal to over 32 per cent. of its weight. Of course in such tests the condition of the track is of great importance; nevertheless, it is common in steam locomotive practice to estimate on not over half this amount of adhesion. A value of 25 per cent. may safely be employed for the adhesive coefficient in the case of electric locomotives, as against some 16 per cent. for steam locomotives.

In a paper read before the Pacific Coast Railway Club,¹ McDoble has touched upon this subject. His estimations of the adhesion coefficient in the case of steam and electric locomotives respectively, are set forth as follows:—

“From 25 to 30 per cent. of the weight of an electric locomotive can be utilised as draw-bar pull, while actual tests have shown that as high as 33 per cent. can be so used. Compared with these figures are coefficients ranging from only 13 to 16 per cent. for the most powerful steam locomotives built. These figures are based on the ratio of the maximum draw-bar pull to the total weight of the locomotive. Considering the comparative weights on the drivers in each case, we find that the electric locomotive shows an increase over the steam, of from 10 to 20 per cent.”

Carter,² however, makes the most explicit statement, and one which the authors feel inclined to regard as the most sound. He states:—

“The weight on driving wheels must be determined before the equipment can be finally settled upon, in order to discover whether the adhesion is sufficient to stand the tractive effort of the motors. The accelerating tractive effort should not exceed about 17 per cent. of the weight on driving wheels in the case of trains driven by motor cars, operated by the multiple-unit system of train control, wherein it is impracticable to sand the rails in front of all driving wheels in bad weather. Where locomotives are used, however, the average accelerating tractive effort may be allowed to amount to 24 or 25 per cent. of the weight on driving wheels, if efficient provision is made for sanding the rails in case of need.”

The Valtellina Three-Phase Gearless Locomotives.

The polyphase motors supplied by Messrs. Ganz & Co. for the Valtellina Railway, have also been of the gearless type, or rather they have all had a speed equal to that

¹ *Electric Journal*, August, 1905.

² “Technical Considerations in Electric Railway Engineering,” paper read before the Institution of Electrical Engineers, January 25th, 1906.

LOCOMOTIVES AND MOTOR CARRIAGES

of the driving wheels, although, as we shall see, the motor, in the latest design of locomotive, transmits its power to the driving wheels through a connecting rod. This arrangement overcomes the necessity for mounting the armature directly upon the driven axle, and introduces further obvious advantages as regards better utilisation of the available space.

First Valtellina Electric Locomotives.

The first locomotives, as illustrated in Fig. 282, were, however, of the true gearless type with the armatures on the driven axles. Each locomotive was equipped with four,

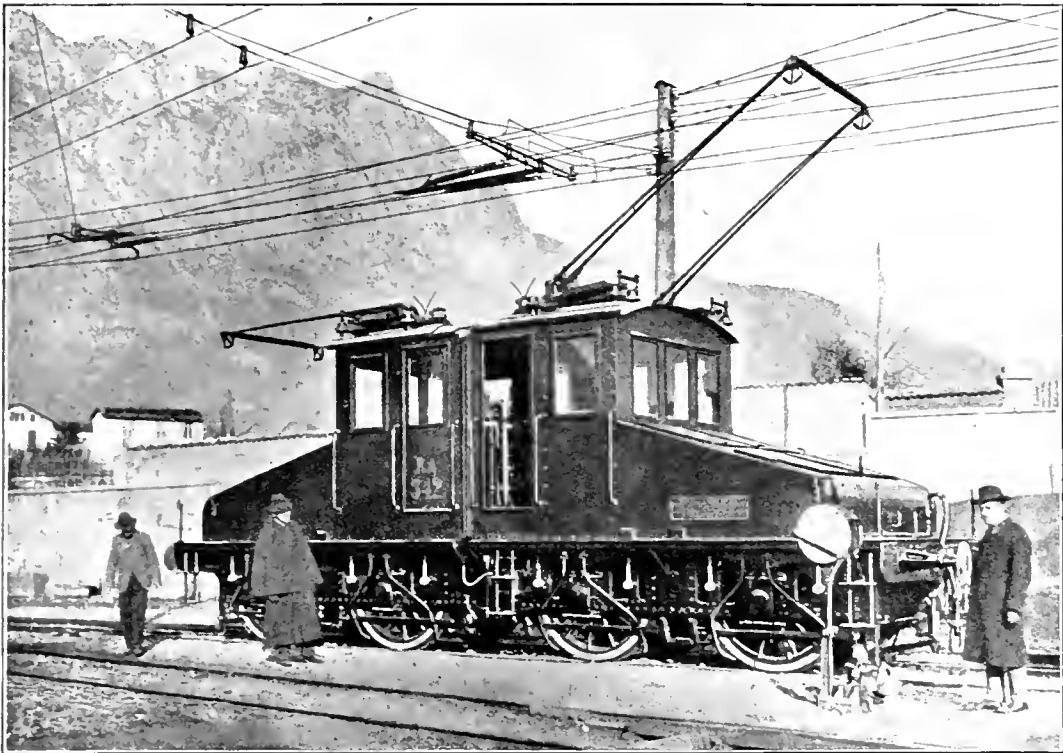

Fig. 282. EARLY TYPE OF VALTELLINA THREE-PHASE GEARLESS LOCOMOTIVE.

three-phase induction motors. The locomotives were mounted on bogie trucks with wheels of 55 ins. diameter, and were equipped with four gearless motors, each of 225 h.-p. rated capacity. As the locomotives were designed for freight haulage at a constant speed of 18.6 miles (30 kilometres) per hour, cascade control was not provided. When it is desirable, with these locomotives, to run the train at a speed lower than normal, resistance is inserted in the rotor circuit. It is further arranged that all the motors or only a part of them may be used, according to the load. The four liquid starters are so constructed that the water level is always the same in all of them, and any level can be maintained for any required time.

These locomotives weigh 47 metric tons. Each motor weighs 4.9 metric tons and

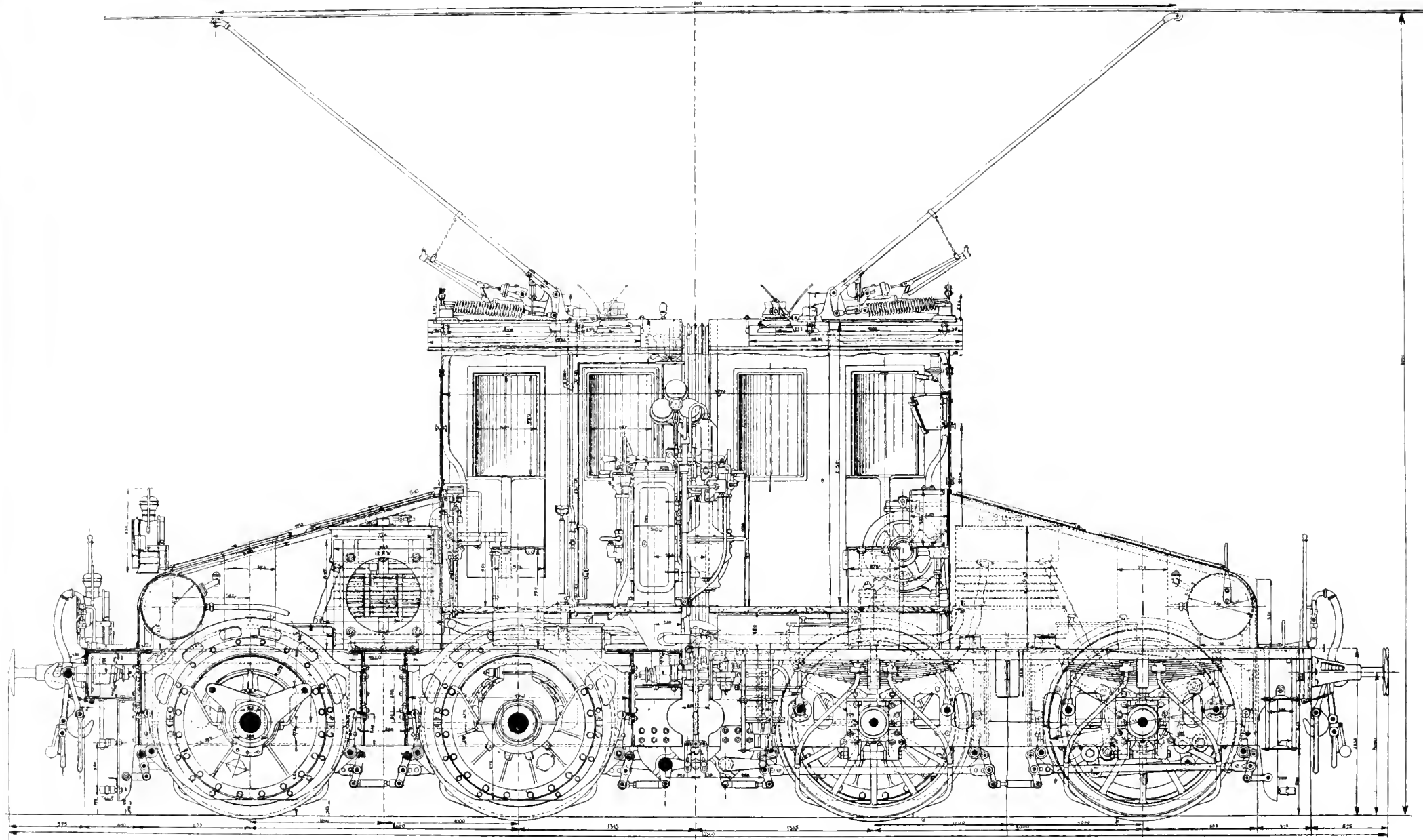

FIG. 283. EARLY TYPE OF VALTELLINA (GEARLESS) LOCOMOTIVE.



ELECTRIC RAILWAY ENGINEERING

design of these locomotives differs radically from that employed for the first Valtellina locomotives. In the first place, they are proportioned for considerably higher speed and power, and weigh 62 metric tons, as against the 47 tons weight of the first locomotives.

The specification to which these 1904 locomotives were required to conform, called for two normal speeds, the first being from 37 to 43 miles per hour, and the second from 18.5 to 21.5 miles per hour. The required tractive force at the rim of the driving wheels is equal to 3.5 metric tons at the higher, and 6.0 metric tons at the lower of these speeds. Each primary motor, when operated at its normal speed of 225 revolutions per minute, has a nominal (1 hour 75 degrees Cent.) rating of 600 h.-p.: hence the nominal rating of a locomotive at its standard full speed is 1,200 h.-p.

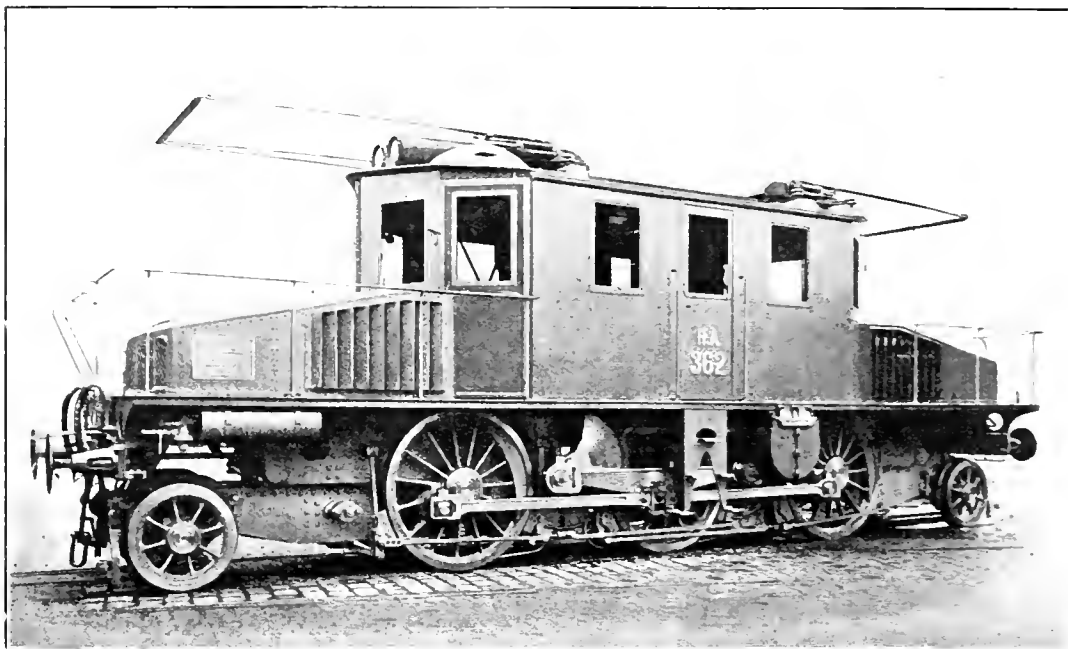

Fig. 287. "1904" TYPE OF VALTELLINA LOCOMOTIVE.

For half-speed the rotors of the primary motors feed the stators of the cascade motors, and the two pairs of motors then have a nominal 1-hour rating of 900 h.-p., or 450 h.-p. per pair of motors. They are required to accelerate a 400-ton train on an incline of 0.1 per cent. in 55 seconds from rest up to a speed of 18.6 miles per hour. They are also required to accelerate a 250-ton train on an incline of 0.1 per cent. from rest to a speed of 37 miles per hour in 110 seconds. These performances correspond to tractive forces some 50 per cent. higher than those given above as normal. Taking the first of these two specified performances, and assuming a uniform rate of acceleration, this works out at $\frac{18.6}{55} = 0.34$ m.p.h. per second. This would require a tractive force of 34 lbs. per ton. The 0.1 per cent. incline would call for a further 2.2 lbs. per ton, or a total of about 36 lbs. per ton. The train, together with the locomotive, weighs $400 + 62 = 462$ tons, and thus there is required to be

LOCOMOTIVES AND MOTOR CARRIAGES

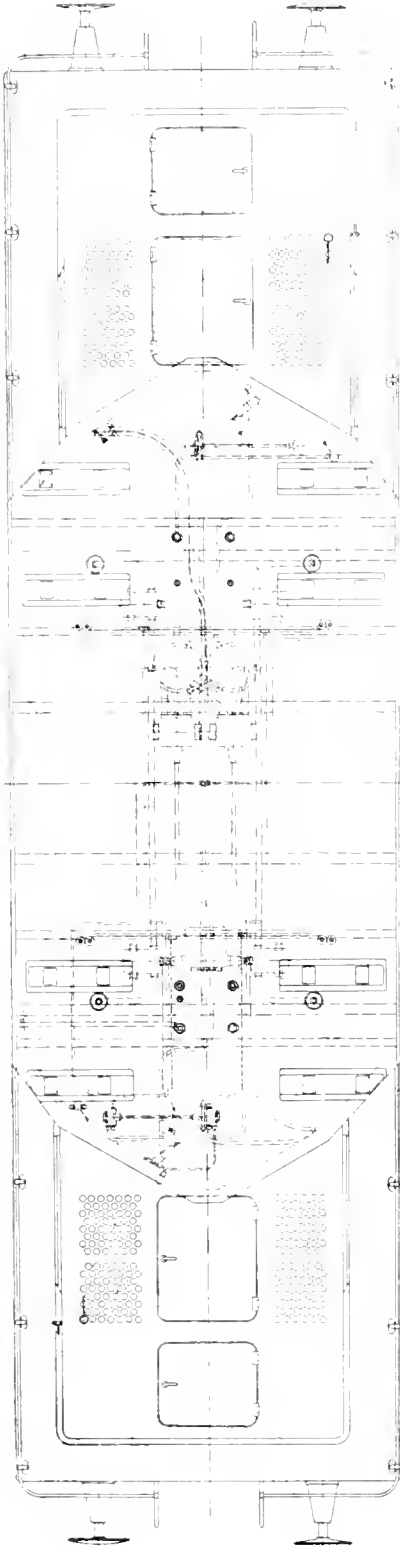

Fig. 290. "1904" TYPE VALTELLINA THREE-PHASE ELECTRIC LOCOMOTIVE.

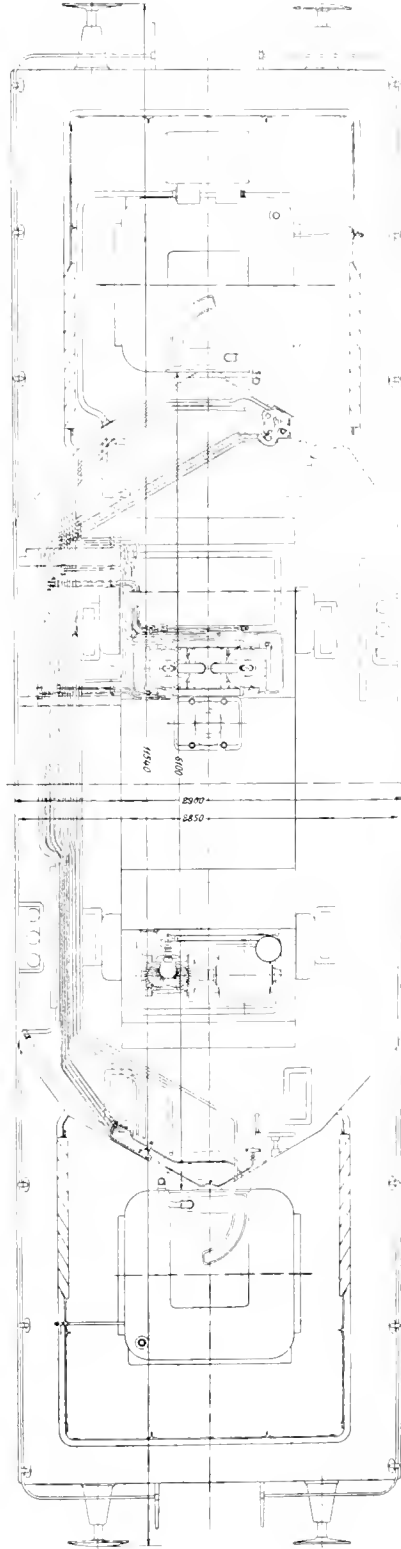

Fig. 291. "1904" TYPE VALTELLINA THREE-PHASE ELECTRIC LOCOMOTIVE.

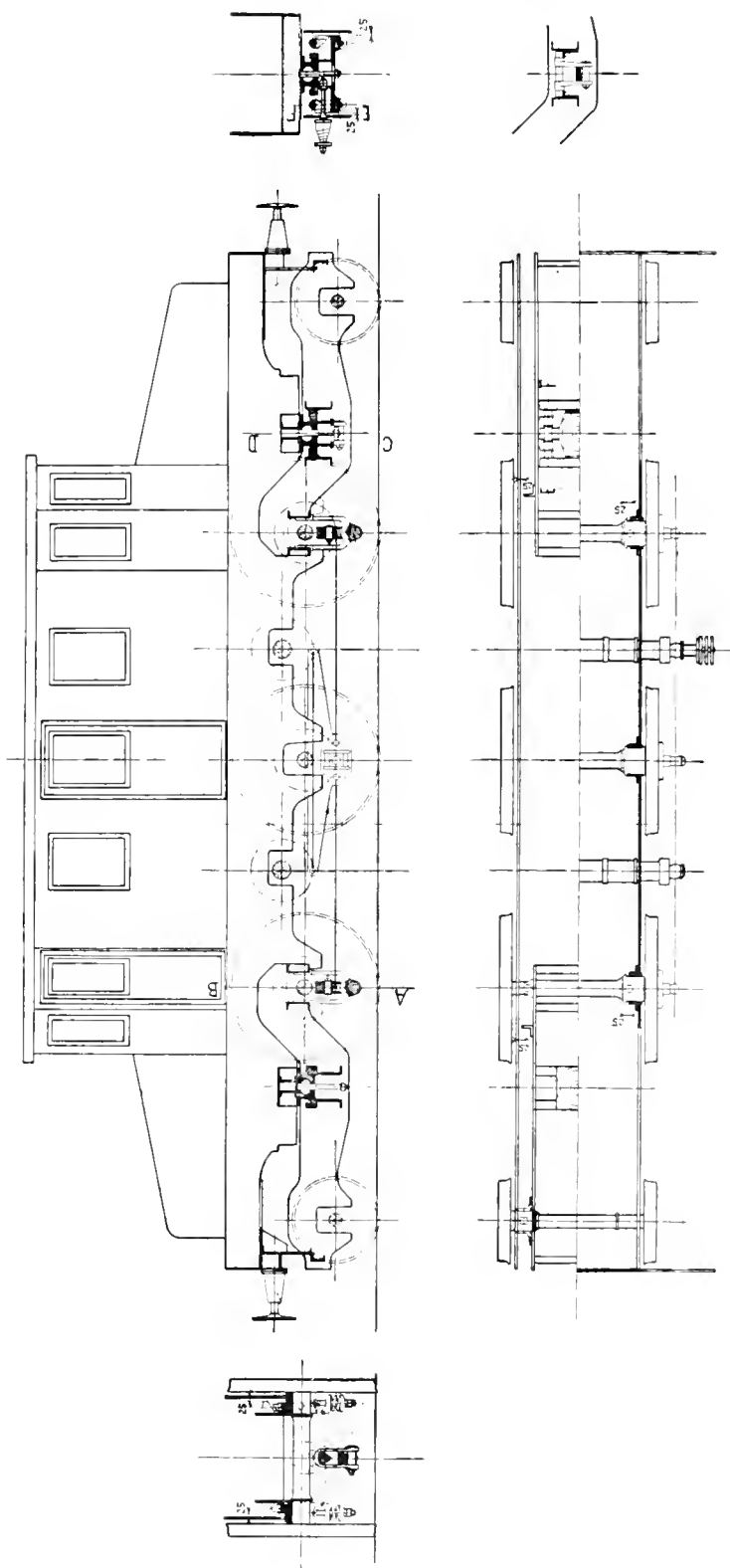

Fig. 292. "1901" TYPE VALTELLINA THREE-PHASE ELECTRIC LOCOMOTIVE.

LOCOMOTIVES AND MOTOR CARRIAGES

by four rods with spiral springs between the heads and the lugs on the frame. A photograph of one of the combination cascade motors is given in Fig. 297, and drawings in Fig. 298. The novel arrangement of the collector rings, as clearly seen in Figs. 297 and 298, is a noteworthy feature. The slip rings are only in circuit when the primary motor is alone in service. For cascade connection, the current from the windings of the primary rotor flows directly to the windings of the low voltage rotor. Carbon brushes are employed with the slip rings. A view of the slip rings with the brushes in

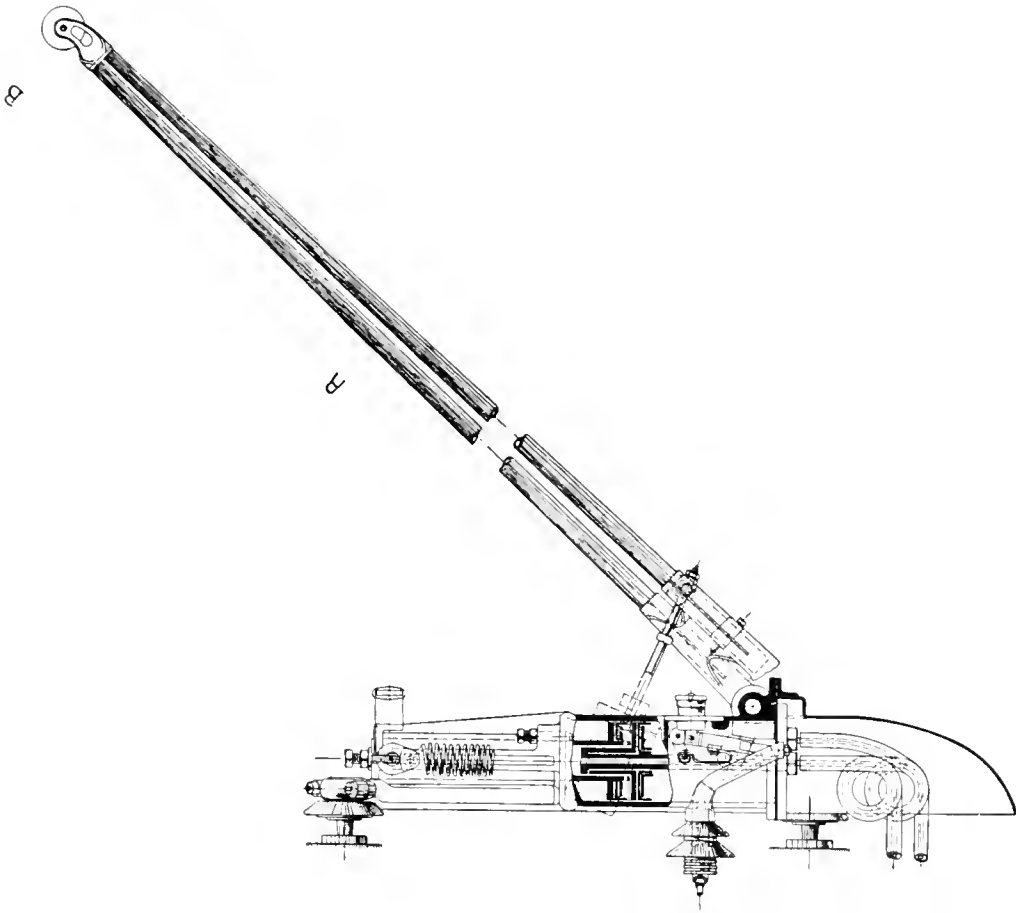

Fig. 293. TROLLEY FOR "1904" TYPE VALTELLINA THREE-PHASE ELECTRIC LOCOMOTIVE.

place is shown in Fig. 299. Each primary motor alone would weigh 8.2 metric tons, but the secondary motor brings the combined weight up to 12.4 metric tons. Hence the total weight of the two combination sets of motors amounts to 24.8 metric tons. The motors therefore constitute **40 per cent.** of the 62 metric tons of total weight of the complete locomotive. Each of the two bogie trucks carries one of these combined primary and secondary motors.

Of the three locomotives supplied, two are equipped with liquid starting rheostats, and one with metallic starting rheostats. The entire control, including the manipulation

ELECTRIC RAILWAY ENGINEERING

of the trolley and of the water rheostats, is effected by means of compressed air. Diagrams of the pneumatic connections are given in Figs. 300 and 301, relating respectively to arrangements with water and metallic rheostats. The controller is provided with such interlocking connections that the motors can only be reversed when the primary circuit is open.

The photograph in Fig. 302 illustrates the motor-driven air compressor. The

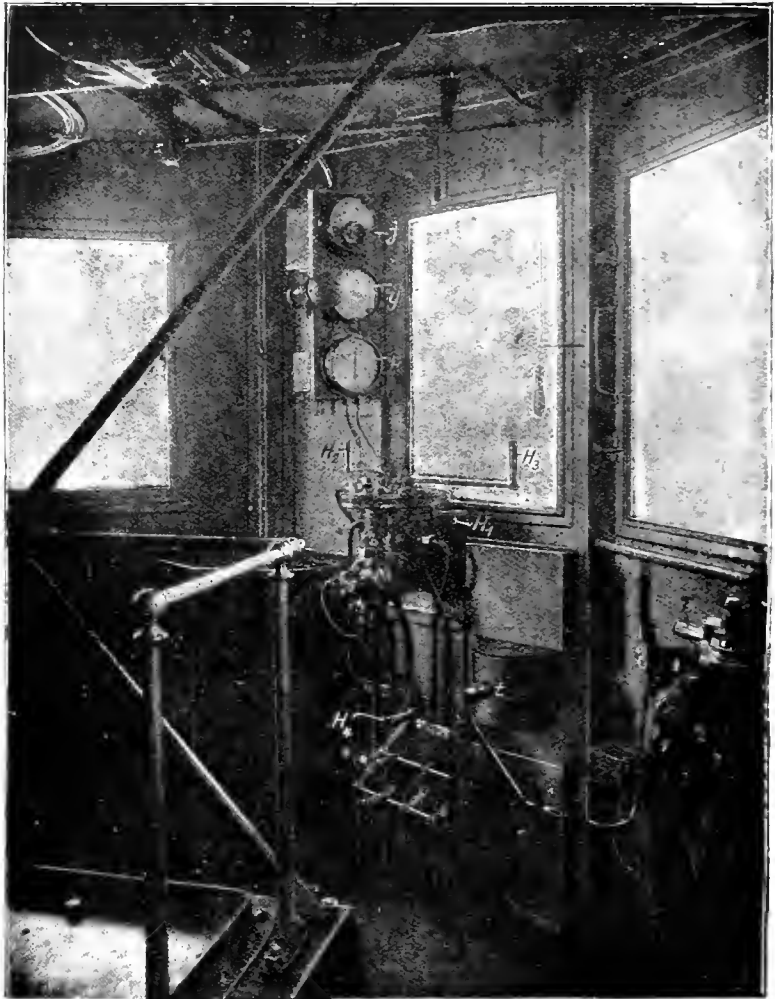

Fig. 294. INTERIOR OF DRIVER'S CAB OF "1904" VALTELLINA LOCOMOTIVE.

motor is supplied from the 110-volt secondary of a 5-kilowatt oil transformer, whose primary windings are fed at 3,000 volts. At its normal speed of 430 revolutions per minute, this compressor can supply 520 litres¹ of air. Two air receivers, located on the roof of the locomotive, are provided. One of these supplies air for the electrical apparatus, and the other for the Westinghouse brakes. The compressor motor is cut

¹ This volume corresponds to atmospheric pressure.

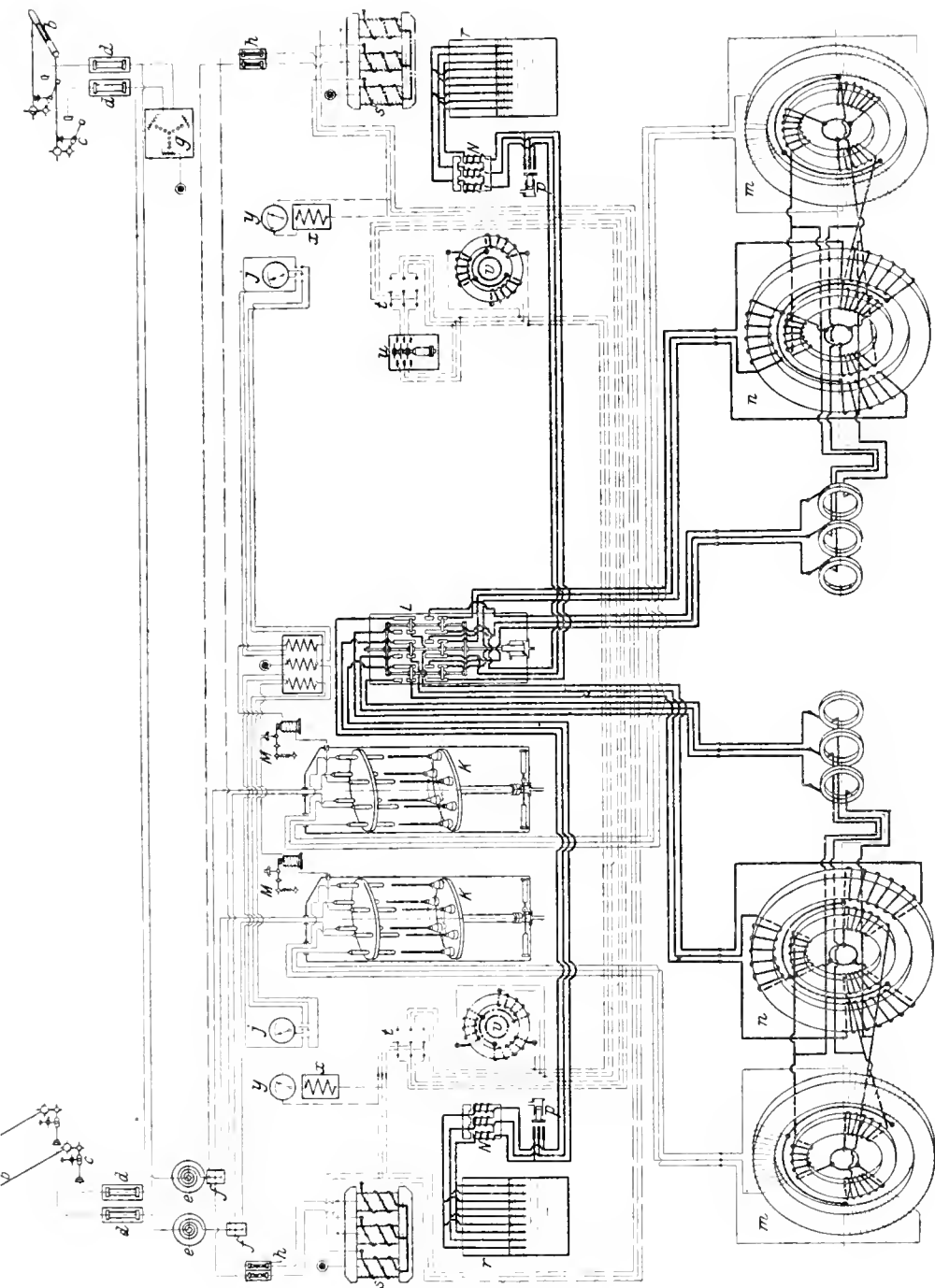

Fig. 295. ELECTRICAL CONNECTIONS OF "1904" TYPE VALELLINA THREE-PHASE ELECTRIC LOCOMOTIVE.

- a* Overhead trolley line.
- b* Current collector.
- c* Circuit breaker.
- d* Main fuse.
- e* Choking coils.
- f* Distribution box.
- g* Lightning arrester.
- h* Transformer fuse.

- j* Ammeter.
- M* High tension circuit-breaker relay.
- K* High tension switch.
- m* High tension motor.
- n* Low tension motor.
- L* Speed control switch.
- p* Short circuiting switch.
- N* Regulator for water rheostat.

- r* Water rheostat.
- s* Transformer.
- t* Hand operated switch for air pump.
- u* Automatic air pressure regulator.
- v* Motor for driving air pump.
- x* Voltmeter resistance.
- y* Voltmeter.

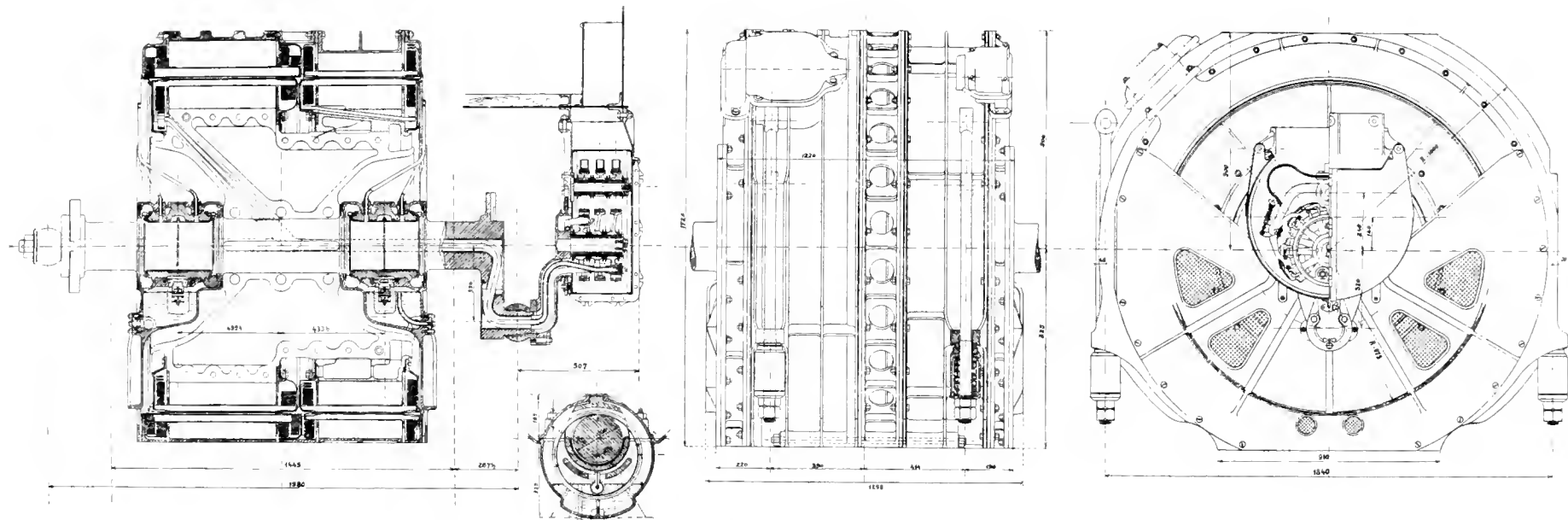

Fig. 208. OUTLINE DRAWINGS OF ONE OF THE CASCADE MOTOR SETS OF THE "1904" TYPE VALIELLINA THREE-PHASE ELECTRIC LOCOMOTIVE.



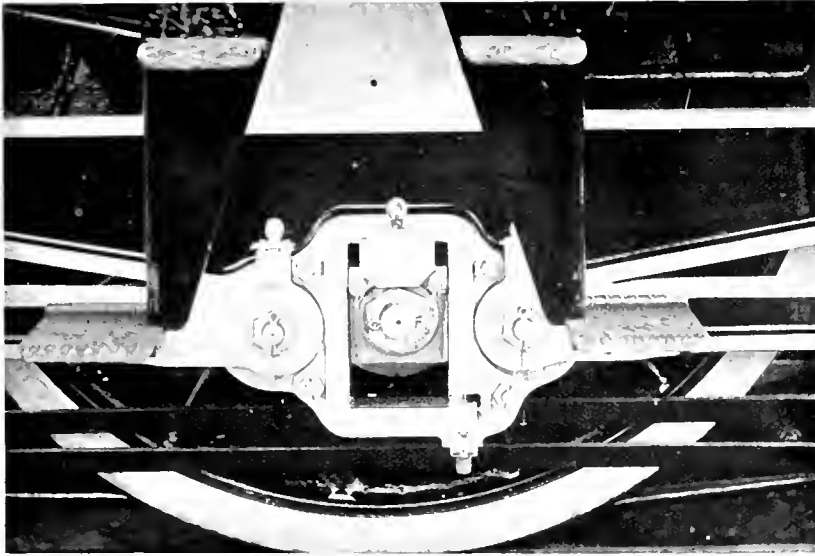

Fig. 296. COMMUNICATING BEARING BETWEEN CRANK AND CONNECTING ROD ON "1904" TYPE VALTELLINA THREE-PHASE LOCOMOTIVE.

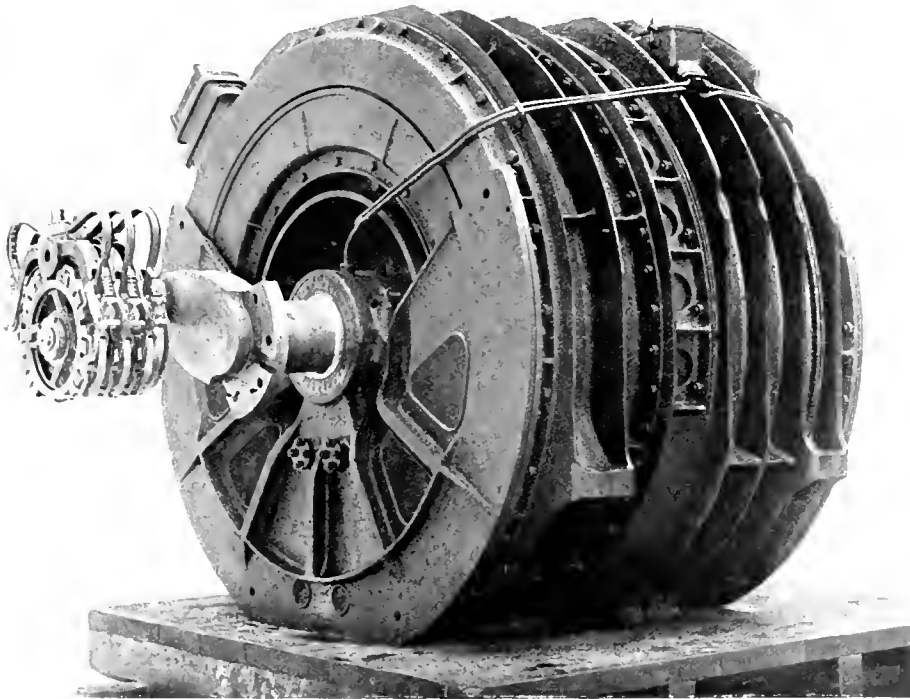

Fig. 297. ONE OF THE CASCADE MOTOR SETS OF THE "1904" TYPE VALTELLINA THREE-PHASE ELECTRIC LOCOMOTIVE.

ELECTRIC RAILWAY ENGINEERING

in and out automatically, according as the pressure in the receivers falls below or rises above a pressure of six atmospheres. Place was originally provided on the locomotive for a second step-down transformer and air compressor, and these have subsequently been installed.

The locomotives are operated from a three-phase line at a periodicity of 15 cycles per second, and a pressure of 3,000 volts. At the power-house the energy is supplied direct from 20,000-volt generators, and is transmitted at this pressure to sub-stations, where it is reduced in stationary transformers to 3,000 volts, and delivered to

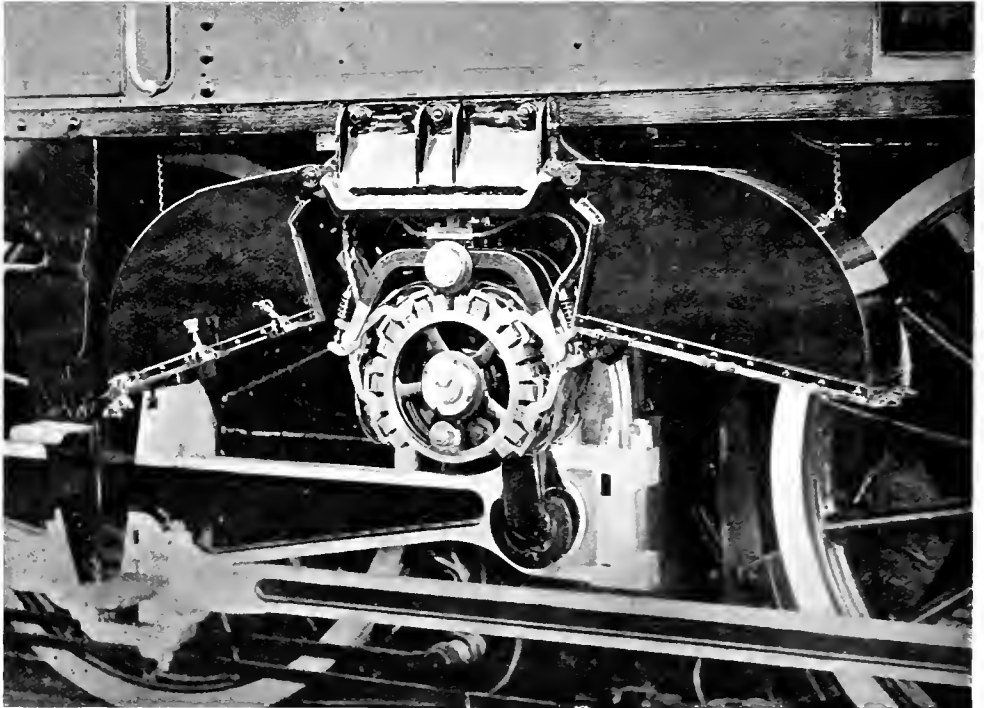

Fig. 299. SHOWING SLIP RINGS OF MOTOR OF "1904" TYPE VALTELLINA THREE-PHASE ELECTRIC LOCOMOTIVE.

the low tension conducting system, which consists of two overhead wires and the track rails. All the three locomotives are in regular service hauling 250-ton passenger and 400-ton freight trains.

Regenerative Features as observed at Valtellina.

Cserhati (*Zeit. Ver. Deut. Ing.* XLVIII., pp. 125—132, January 28th, 1905) has pointed out an interesting feature observed on the Valtellina road. It is found that, in spite of the relatively infrequent service of heavy trains, the fluctuations in the load at the power-house are relatively small. Thus for the entire day, the maximum load is only three times the average load, and if one deducts those hours during which only a single train is running, and for which a single generating set suffices, and considers only the remaining part of the day, then the maximum load is only

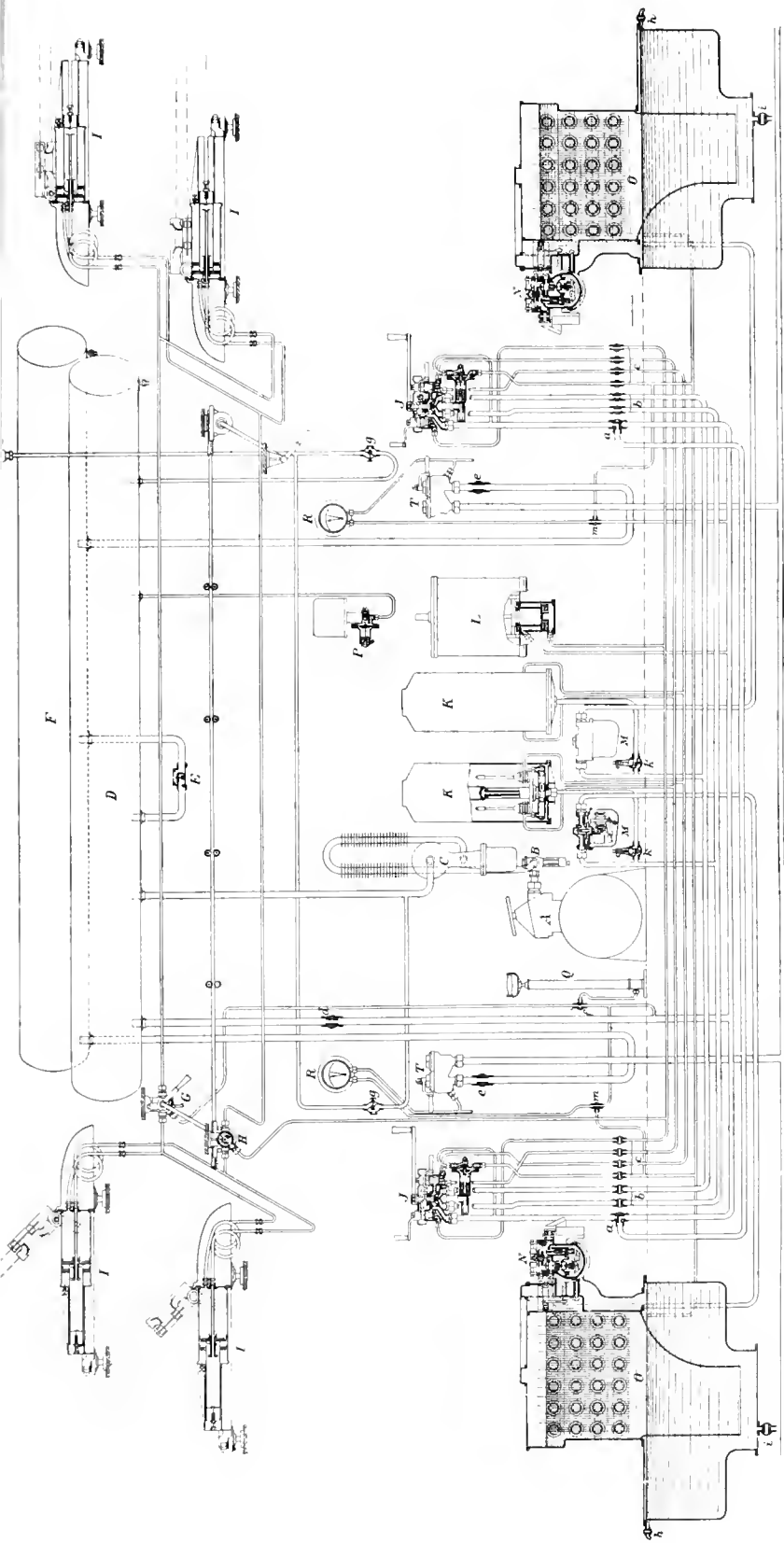

Fig. 300. DIAGRAM OF PNEUMATIC CONTROL CONNECTIONS FOR THE WATER RHEOSTAT TYPE OF VALTELLINA "1904" THREE-PHASE LOCOMOTIVE.

- A Air pump.
- B Valve with oil break.
- C Oil separator.
- D Air receiver for the electrical apparatus.
- E Same as B.
- F Air receiver for the Westinghouse brake.
- G Direct driven switch for the current collector.
- H Immediately driven switch for current collector.
- I Base for current collector.
- J Pneumatic switch operated by driver.
- K High-tension switch.
- L Speed control switch.
- M Maximum circuit breaker relay.
- N Regulator of the water rheostat.
- O Water rheostat.
- P Automatic air pressure regulator.
- Q Hand operated air pump.
- R Air pressure indicator.
- S Whistle.
- T Westinghouse brake.
- U Cut off and safety cock.
- V Cut off cock to the two groups of motors.
- W Cut off cock to the two groups of motors.
- X Main cut off cock.
- Y Cut off.
- Z Cut off connection cock.
- a Whistle valve.
- b Testing cock for water rheostat.
- c Discharge cock for water rheostat.
- d Throw over valve from main switch.
- e Diverting cock between the pressure indicator and the air receiver and air release.

ELECTRIC RAILWAY ENGINEERING

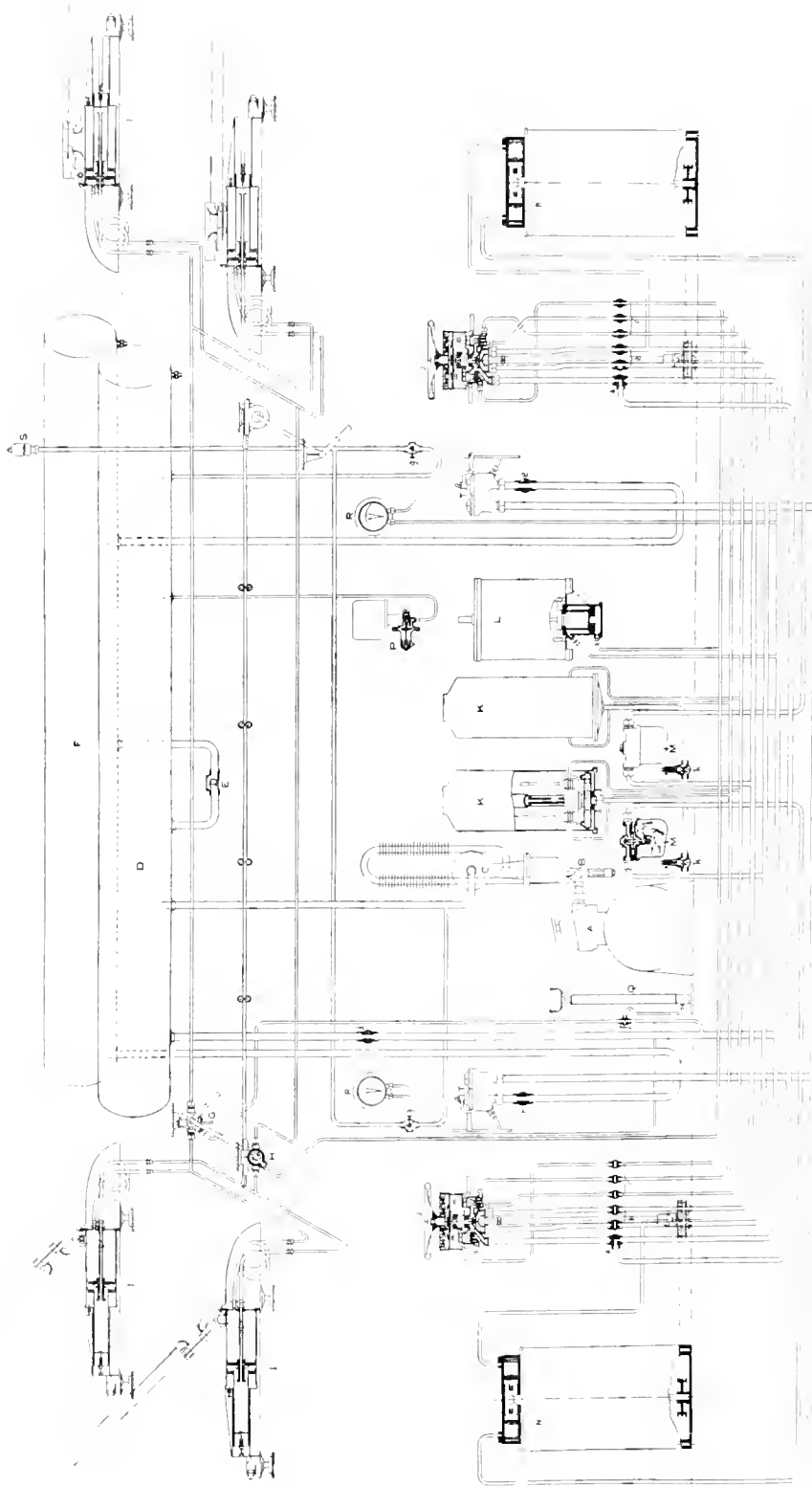

Fig. 301. DIAGRAM OF PNEUMATIC CONTROL CONNECTIONS FOR THE METALLIC RHEOSTAT TYPE OF VALVELESS TYPE OF THREE PHASE LOCOMOTIVE.

- | | | |
|--|---|---|
| <p>A Motor-driven air pump.
 B Valve with air brake.
 C Oil separator.
 D Air receiver for the electrical apparatus.
 E Valve.
 F Air receiver for the Westinghouse brake.
 G Regulating valve of the current collector direct coupled.
 H Regulating valve of the current collector indirectly coupled.</p> | <p>J Base for the current collector.
 J Pneumatic switch operated by driver.
 K Primary switch.
 L Speed control switch.
 M Maximum relay.
 N Switch for metal rheostat.
 O Air pressure regulator.
 P Hand operated hand pump
 R Air-pressure indicator.
 S Whistle.</p> | <p>T Westinghouse brake valve.
 a Cut off and safety cock.
 b Cut off cock to the two groups of motors.
 c Cut off cock to the two groups of motors.
 d Main cut off cock.
 e Cut off cock for Westinghouse brake valve.
 f Cut off and connection cock.
 g Whistle valve.
 k Throw over valve for main switch.</p> |
|--|---|---|

LOCOMOTIVES AND MOTOR CARRIAGES

1.8 times the average load. Now the generators are driven by water power, and the speed regulation is none too good. This, however, is the basis of the advantage to which Cserhati calls attention, namely, that, should several trains start up at once, the drop in speed of the generating sets is so great that the induction motors of the trains running at normal speed at the time, act as generators, and feed back into the line, and, in fact, pull the power-house generators up to speed again. Thus extreme peaks of load are avoided. Cserhati describes the trains on the line as constituting the equivalent of a gigantic fly-wheel which materially decreases the overload shocks on the

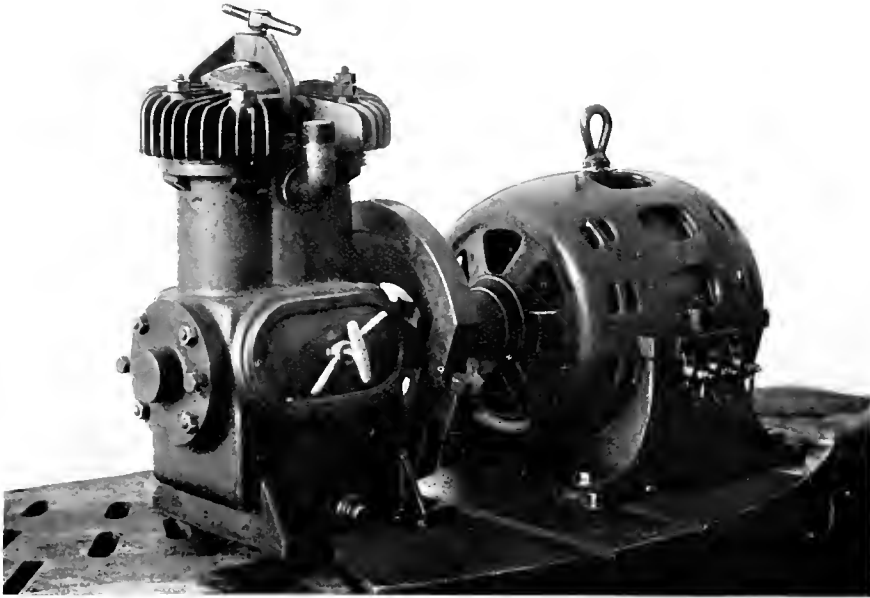

Fig. 302. MOTOR-DRIVEN AIR COMPRESSOR FOR THE "1904" TYPE VALTELLINA THREE-PHASE ELECTRIC LOCOMOTIVE.

power-house plant. The relatively low amount of power required is stated to be also in part due to the smooth starting rendered practicable by the use of water rheostats.

1906 Ganz Locomotive Supplied to the Italian State Railways.

On an order for the Italian State Railways, Messrs. Ganz & Co. have now (1906) just completed two new three-phase high tension locomotives. One of these is shown at the International Simphon Exhibition at Milan. This new type of locomotive is, as regards its mechanical parts, similar to the three electric locomotives last supplied by Messrs. Ganz & Co. for the Valtellina Railway, and only differs from them in the electrical equipment in so far that, instead of having twin motors, it is equipped with two single motors, which are disposed in the locomotive similarly to the twin motors of the previous locomotives. Both motors are high tension motors, one having eight poles, the other twelve poles, and the independent connection of these motors and the cascade connection of both allows of the use of three economical speeds corresponding to the number of poles, *i.e.*, eight, twelve, and twenty, thus permitting of speeds of 64, 42½, and 25 kilo-metres per hour. The rated capacity of the motor with eight

ELECTRIC RAILWAY ENGINEERING

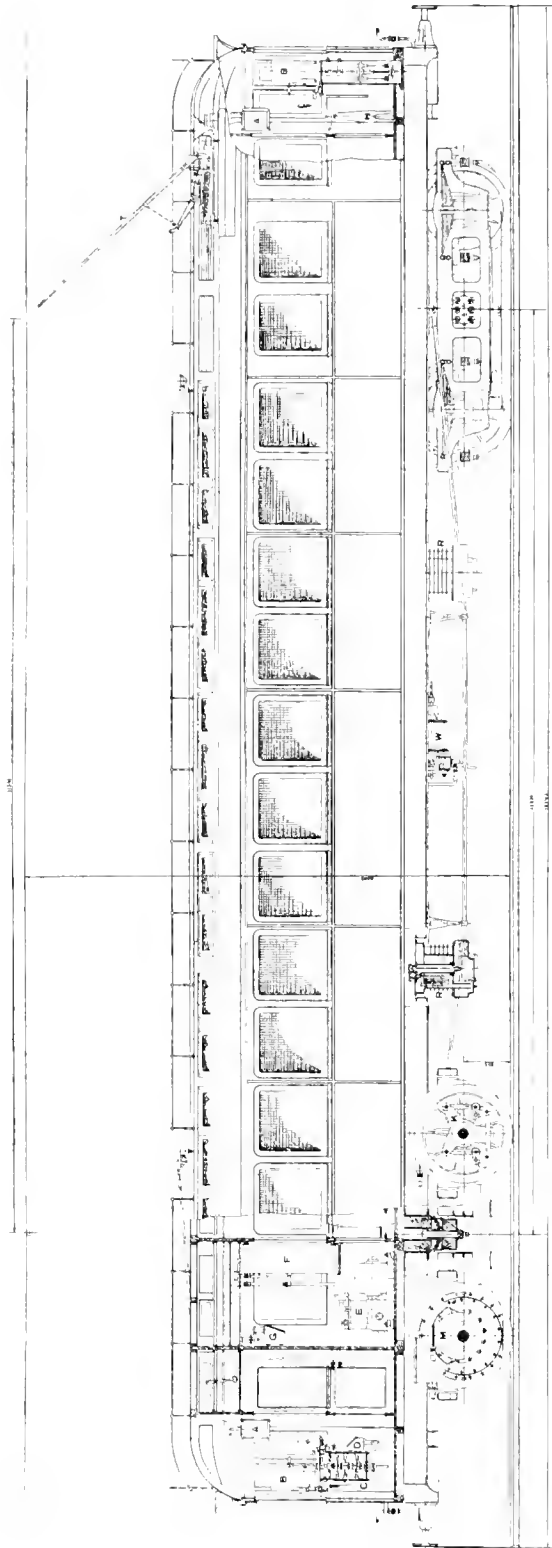

Fig. 363. MOTOR CAR OF THE VALDEQUINA RAILWAY, EQUIPPED WITH FOUR POLYPHASE MOTORS.

- A Connection box.
- B Main switch.
- C Controller.
- D Short circuiting switch for motor.
- E Air compressor.
- F Air receiver.
- G Automatic switch.
- H Hand brake.
- K Coupling.
- M Motor.
- R Water resistance.
- T Trolley.
- W Westinghouse brake.

LOCOMOTIVES AND MOTOR CARRIAGES

poles is 1,500 h.-p.; that of the twelve pole motors is somewhat smaller. Valatin has kindly informed the authors that the 1,500 h.-p. motor weighs 13.1 metric tons. Its synchronous speed is 225 R.P.M.

Valtellina Motor Cars.

The original equipment of electrical rolling stock for the Valtellina Railway also comprised ten motor cars for passenger traffic. Each motor car weighs 53 tons, and generally hauls five coaches, the total weight of the train being 150 tons. A drawing of one of the motor cars is given in Fig. 303. The trains have two economical running

speeds, a speed of about 40 miles per hour employed for the main journey of express passenger trains, and a speed of 20 miles per hour employed when running through stations or up heavy inclines. The lower speed is also used for local trains. The cascade system of control is employed for obtaining these two speeds. Each car has four motors, of which two are wound for 3,000 volts, and two for the lower pressure of 300 volts. Each of the four motors weighs 3.8 metric tons. Each series pair of these motors develops 150 h.-p. in cascade connection, *i.e.*, at half-speed. At full speed, the high tension motors alone are able to develop 150 h.-p. at their normal speed of 300 revolutions per minute. The rated capacity of each motor on the one hour 75 degrees Cent. basis is 250 h.-p. They are able to give 150 h.-p. during 10 hours without heating more than 45 degrees Cent., and in actual working they are also loaded up to 300 h.-p.

The motors are gearless, transmitting their power to the spokes of the wheels by means of elastic couplings. Figs. 304 and 305 show this coupling, which is intended to allow the rotor to run uniformly even when the wheels are subjected to severe concussions. The rotor laminations are mounted on a hollow shaft, concentric with the train axle. The maximum clearance between the two concentric shafts is $1\frac{3}{4}$ ins. Bogie trucks are used, and their construction may be seen from Fig. 306.

A feature of the motor construction, to which attention may well be drawn, is that the lower part of the stator is flattened off. This allows a larger motor to be used with the 46-in. driving wheels than would otherwise have been possible. In the control of the motor cars, compressed air has been used to a very great extent. An air-pump is driven by a 4 h.-p. motor. The pressure in the air-pump is about six metric



Fig. 304. THREE-PHASE MOTOR MOUNTED ON AXLE OF VALTELLINA MOTOR CARRIAGE.

ELECTRIC RAILWAY ENGINEERING

atmospheres, and is regulated automatically. Provision has been made for hand regulation in case of failure of the automatic control. The compressed air is used for the following purposes:—

- (1) Switching the primary circuit on and off;
- (2) Operating the Westinghouse brakes;
- (3) Raising the trolley;
- (4) Controlling the liquid starter and the whistle.

It is stated that the experience on the Valtellina road has shown electric locomotives to be preferable to motor cars. Both electric locomotives and motor cars are

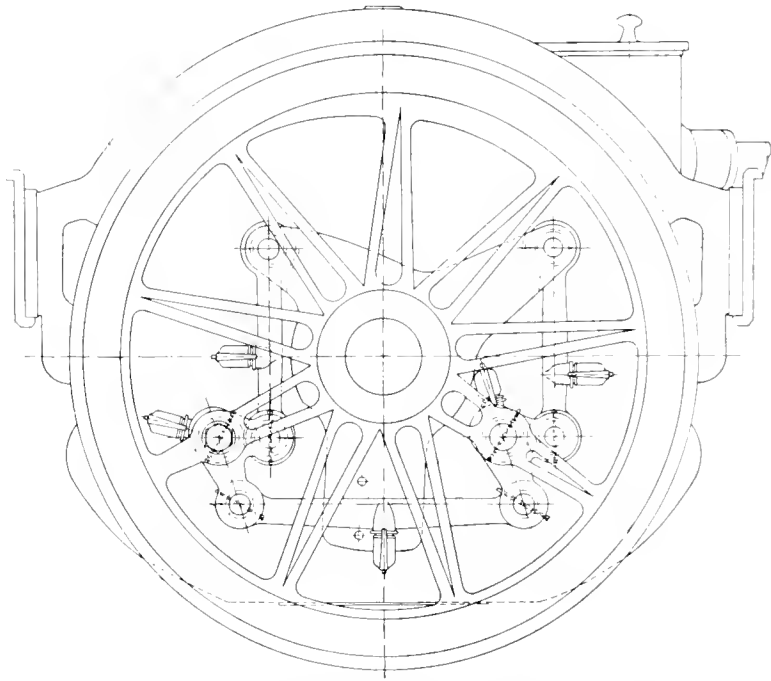

Fig. 305. ELASTIC COUPLING BETWEEN WHEEL AND MOTOR OF VALTELLINA MOTOR CARRIAGE.

employed on this road, and the average yearly mileage has amounted to 34,000 miles per electric locomotive or motor car, as against a yearly average mileage of only 17,000 miles per steam locomotive on the entire Adriatic line of which the Valtellina line is one section. This advantage of two to one in favour of the electric locomotives and motor cars is stated to be largely due to the absence of the steam boilers, the attendance and repairs on which are stated to be the chief causes for the large amount of time that the steam locomotives are out of service. The higher average speed of the electric trains must also have contributed considerably to the higher annual mileage per electric locomotive and motor car, as also the greater ease of manipulation in shunting, etc. There is evidently so great an advantage in this respect, that a much smaller percentage of spare locomotives should afford equal security of uninterrupted maintenance of the traffic with electric than with steam service.

Incidentally we may mention an advantage of electric locomotives over motor

LOCOMOTIVES AND MOTOR CARRIAGES

cars. The heating of the motors limits the output of a modern electric equipment on continuous service. Obviously, a much higher output can be maintained for a short

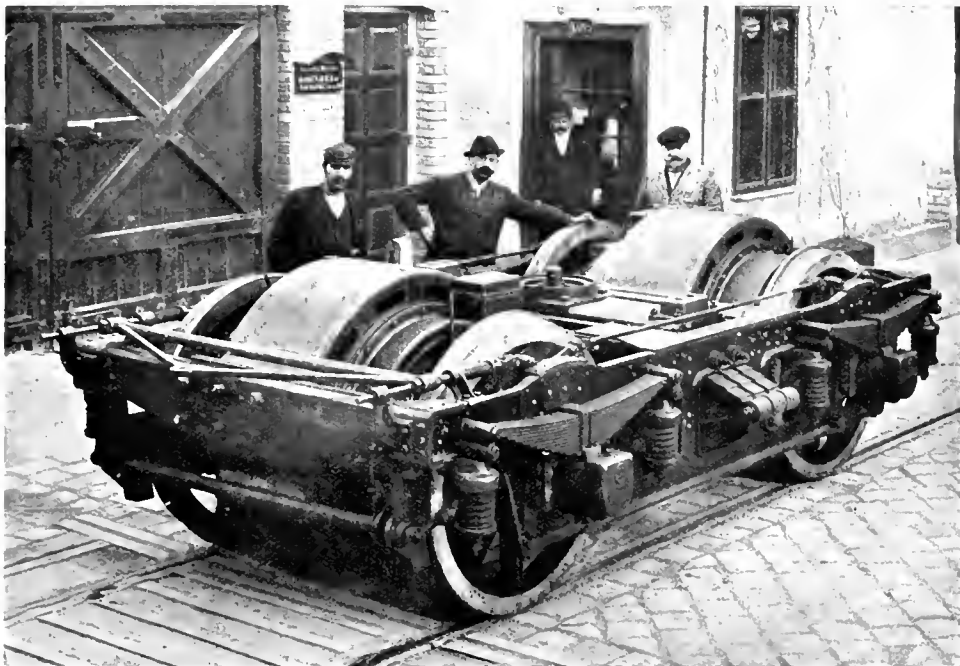

Fig. 306. ONE OF THE BOGIE TRUCKS OF A VALTELLINA MOTOR CARRIAGE, WITH THREE-PHASE MOTORS.

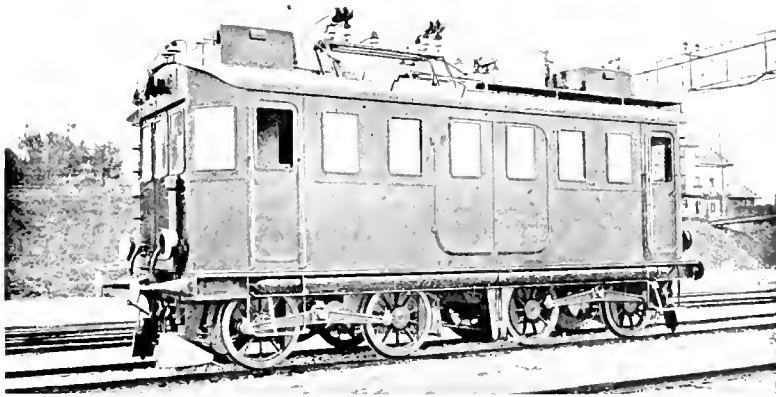

Fig. 307. OERLIKON 15,000 VOLT, 15-CYCLE LOCOMOTIVE EQUIPPED WITH SINGLE-PHASE COMMUTATOR MOTORS.

time. A locomotive may lay over after some heavy work, its place being taken by a fresh locomotive. This would be impracticable with the passenger cars of trains making a long journey.

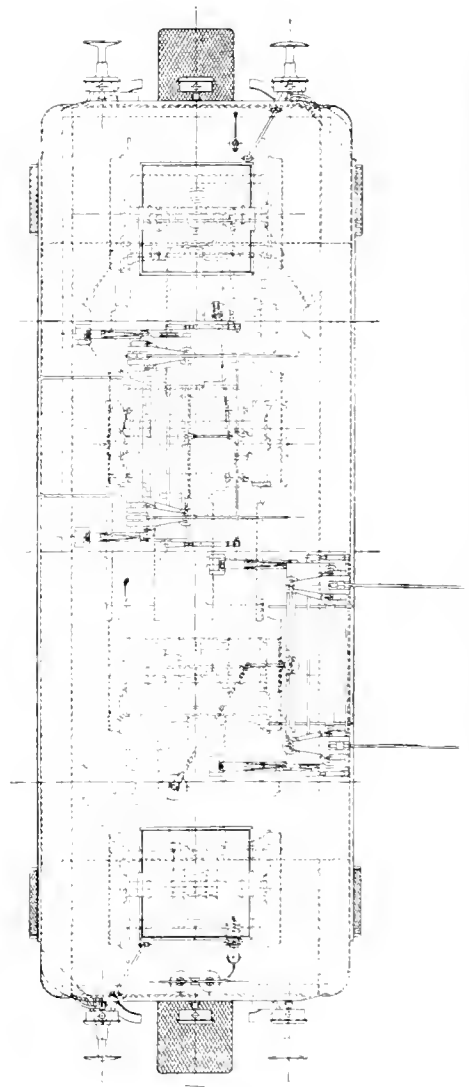
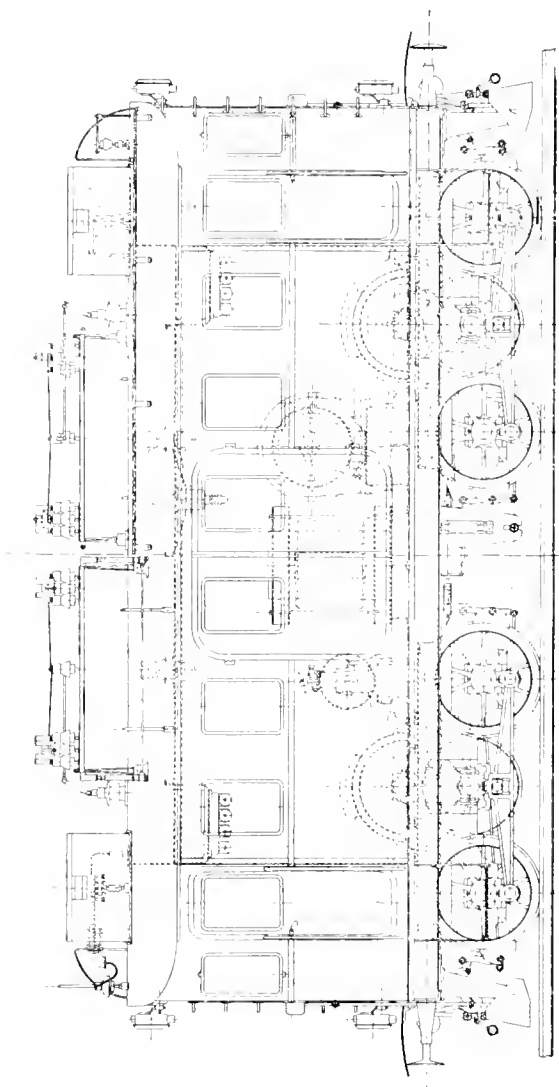
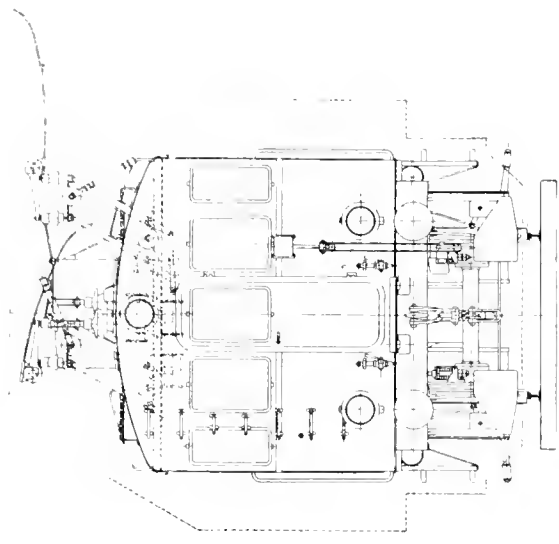

Fig. 308. OERLIKON 15,000-VOLT 15-CYCLE LOCOMOTIVE, EQUIPPED WITH SINGLE-PHASE

LOCOMOTIVES AND MOTOR CARRIAGES

Oerlikon 15,000-volt, Fifteen-cycle Locomotive, Equipped with Single-phase Commutator Motors.

In this single-phase locomotive, as in the latest Ganz three-phase locomotives, the motors ultimately deliver their power to the driving wheels through cranks and connecting rods, but, unlike the Ganz equipments, the Oerlikon motors also have speed reduction gearing. This may be seen from the photograph in Fig. 307, and from the drawings in Figs. 308 and 310. The periodicity is 15 cycles per second, and the trolley pressure is 15,000 volts. The current is collected at this high pressure by the standard Oerlikon collecting device, which may be seen in the above illustrations, and also in Figs. 318 to 321, given on pp. 352 to 354, in connection with the description of another type of Oerlikon locomotive. The current collected at the trolley is next carried through two air-cooled transformers located at the middle of the locomotive. These are of the dimensions shown in Fig. 309, and serve to reduce the potential from 15,000 volts to 600 volts. Each has a capacity for delivering 200-kilo-volt-amperes continuously. The secondary winding is divided into twenty equal sections, there thus being 30 volts per section.

The equipment comprises two single-phase commutator motors, with a rated capacity of 200 h.p. each, at a speed of 650 revolutions per minute. The motor, which has eight main poles and eight auxiliary reversing poles, is illustrated by the drawings in Fig. 310, and by the photograph in Fig. 311. A diagram illustrative of the principles of operation of this type

of motor is given in Fig. 312, from D.R.P. No. 30,388. As built, however, these principles were only partly incorporated. The compensating winding, for instance, threaded through apertures in the main poles, is omitted. In Fig. 313 is given the connection diagram of the wiring of this locomotive. The curves in Figs. 314 and 315 are plotted from test results obtained on the motors. At the normal speed of 650 revolutions per minute, the motor runs at nearly three times its synchronous speed for 15 cycles per second. The gear ratio is 1 to 3.1. The air compressor is driven by an additional 6 h.p. 500 revolutions per minute single-phase commutator motor supplied at a pressure of 240 volts. The compressed air is stored up in two receivers at a pressure of from 6.5 to 7.0 atmospheres, and is equipped with automatic control. The lighting at 15 cycles is thoroughly satisfactory, owing to the use of 20-volt lamps, which therefore have such a stout filament as to remain at practically constant incandescence in spite of the low periodicity.

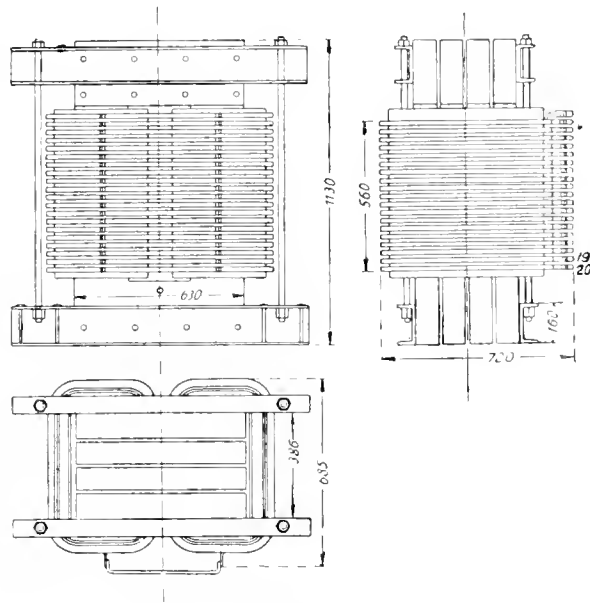

Fig. 309. OUTLINE DRAWINGS OF 200 KILOVOLT AMPERE AIR BLAST TRANSFORMER OF WHICH TWO ARE INSTALLED ON THE OERLIKON 15,000 VOLT, 15-CYCLE LOCOMOTIVE WITH SINGLE-PHASE COMMUTATOR MOTORS (DIMENSIONS IN MILLIMETERS).

ELECTRIC RAILWAY ENGINEERING

The total weight of the locomotive is 43 metric tons. Some of the itemised weights are given in Table CV.

TABLE CV.

Itemised Weights of Oerlikon 15,000-volt Fifteen-cycle Locomotive, with Single-Phase Commutator-Motors.

Cab and two bogie trucks	23.5 tons.
Electrical equipment and brake equipment	16.5 ..
One motor, exclusive of gearing	3.4 ..
Speed-regulating switch, complete in tank of oil	0.3 ..

Some runs were made with this locomotive hauling a 200-ton train, and it was shown that not only during starting with this load, but also during running at a speed

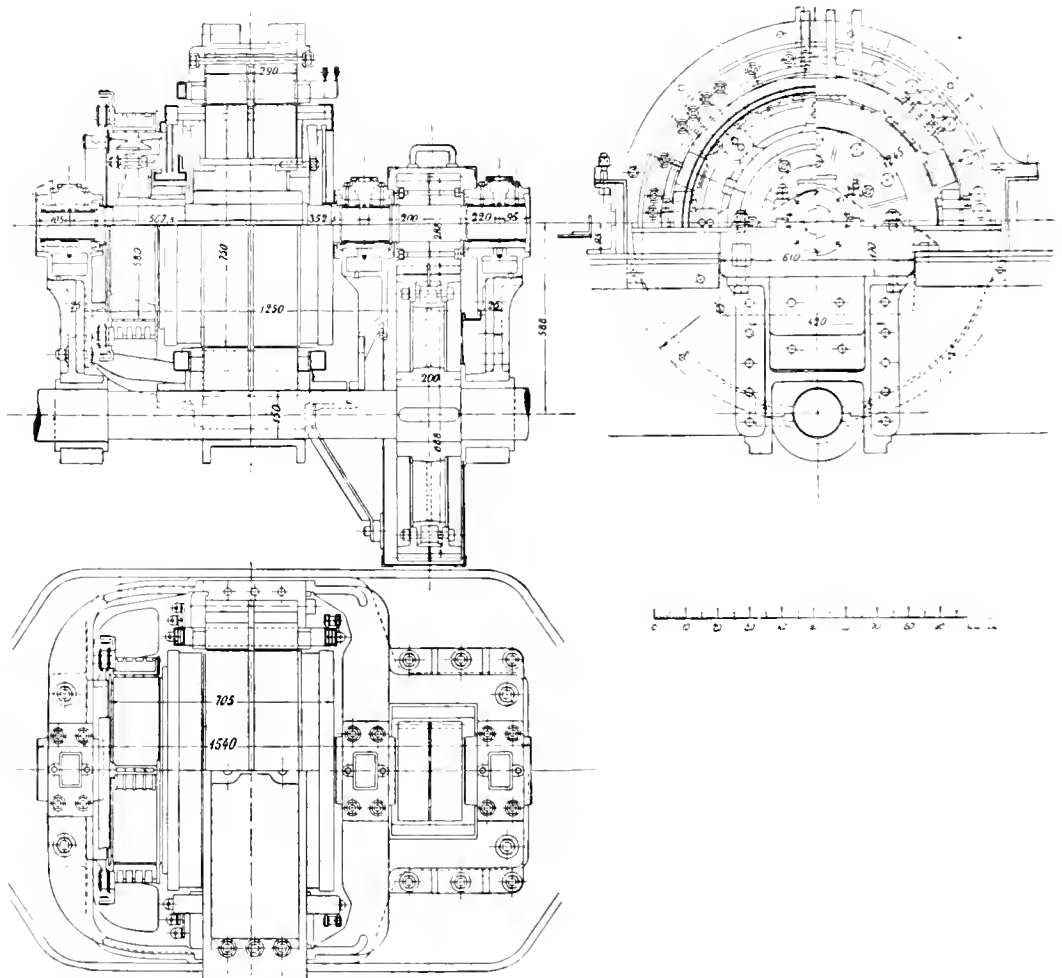

Fig. 310. 200 H.-P. SINGLE-PHASE COMMUTATOR MOTOR WITH REVERSING POLES AS INSTALLED ON THE 15,000 VOLT, 15-CYCLE OERLIKON LOCOMOTIVE.

LOCOMOTIVES AND MOTOR CARRIAGES

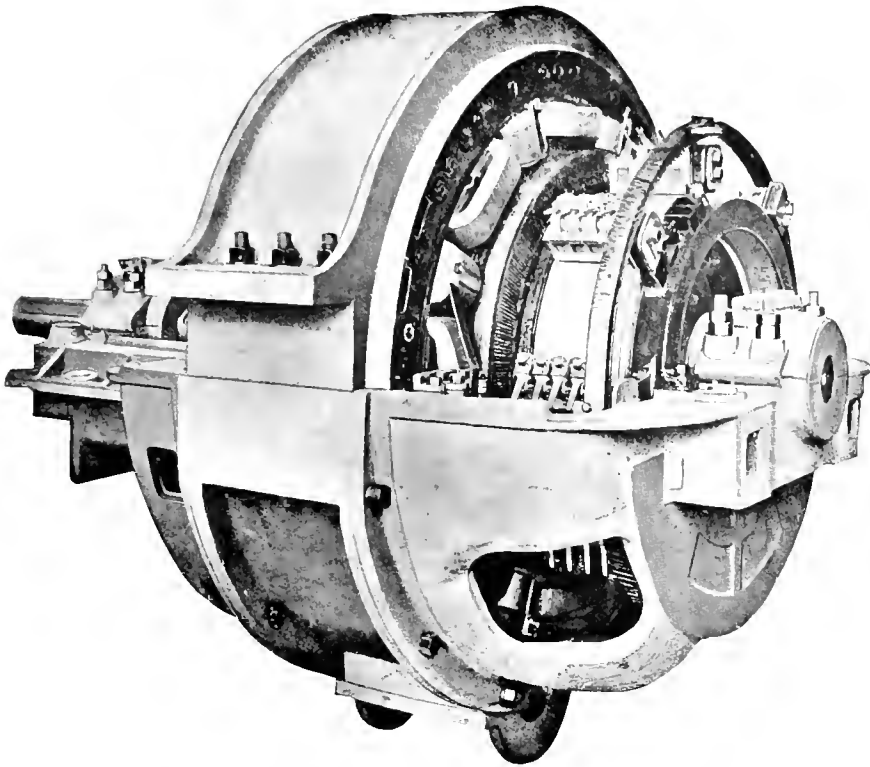

Fig. 311. 200 H.P. SINGLE-PHASE COMMUTATOR MOTOR WITH REVERSING POLES, AS INSTALLED ON THE 15,000 VOLT, 15-CYCLE OERLIKON LOCOMOTIVE.

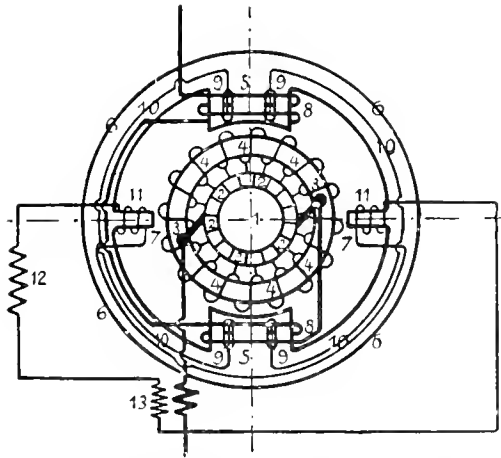

Fig. 312. DIAGRAM OF PRINCIPLES OF OPERATION OF 200 H.P. SINGLE-PHASE INTER-POLE COMMUTATOR MOTORS OF THE TYPE EMPLOYED ON THE OERLIKON 15,000 VOLTS, 15-CYCLE LOCOMOTIVE.

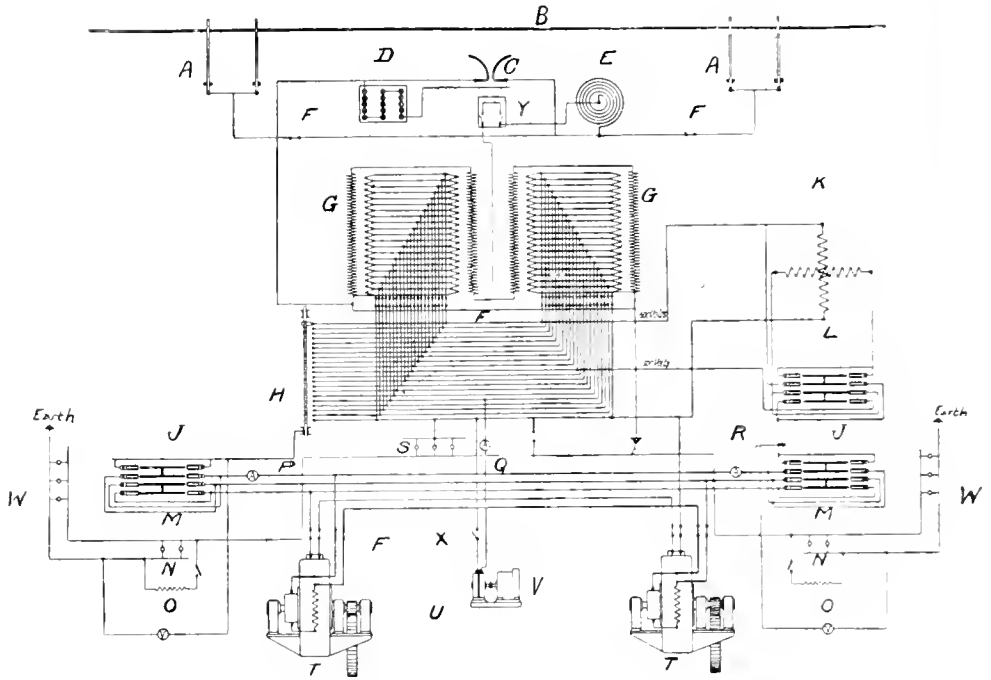

Fig. 313. CONNECTION DIAGRAM OF WIRING OF OERLIKON 15,000 VOLT, 15-CYCLE LOCOMOTIVE WITH SINGLE-PHASE COMMUTATOR MOTORS.

- | | |
|--|--|
| <p>A — Collecting device.
 B — Overhead trolley wire.
 C — Horn lightning arrester.
 D — Multiple cup lightning arrester.
 E — Circuit closer.
 F — 230 k.w. transformer — transforming from 15,000 volts primary to 600 volts secondary.
 G — Potential regulator.
 H — Low tension main switch.
 I — Induction regulator for + 150 volts and 600 amperes.
 K — Reversing switch for induction regulator.
 L — Lamps in motorman's compartment.
 M — Heating coil.
 N —</p> | <p>a — Voltmeter for 700 volts.
 P — Low tension main ammeter.
 Q — 50 ampere ammeter in air pump motor circuit.
 R — 900 ampere ammeter in low tension main circuit.
 S — Lamps in compartment containing the apparatus.
 T — 200 h.p. single-phase commutator motor for 3000 volts, 15 cycles.
 U — Single-phase commutator motor for 120 volts for driving air pump.
 V — Air pump.
 W — Lamps on the side walls of the locomotive.
 X — Automatic regulating switch for motor driving air pump.
 Y — Pneumatic overload circuit breaker.</p> |
|--|--|

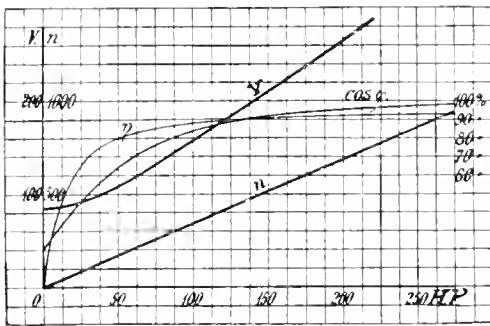

Fig. 314. CHARACTERISTIC CURVES OF OERLIKON 200 H.P. SINGLE-PHASE COMMUTATOR MOTOR (CURRENT CONSTANT AT 200 AMPERES).

- V_n — Terminal voltage.
 n — Speed in revs. per minute.
 $\cos \phi$ — Power factor.
 η — Efficiency.

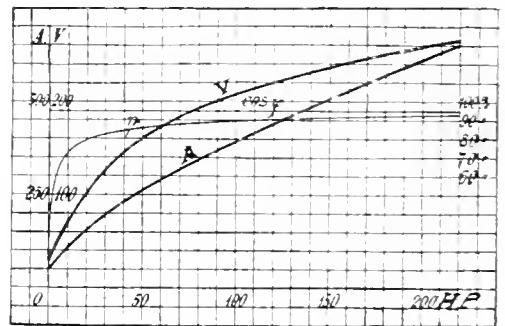

Fig. 315. CHARACTERISTIC CURVES OF OERLIKON 200 H.P. SINGLE-PHASE COMMUTATOR MOTOR (SPEED CONSTANT AT 650 R.P.M.).

- V — Terminal voltage.
 n — Speed in revs. per minute.
 $\cos \phi$ — Power factor.
 η — Efficiency.
 A — Current in amperes.

LOCOMOTIVES AND MOTOR CARRIAGES

of about 25 miles per hour on an upgrade of 0.8 per cent., there was no sparking at the commutator.

With the motors in series, the starting current for this load was about 1,000 amperes in the motors. It was about 780 amperes when running up a grade of 0.8 per cent. with this load, at a speed of 17 miles per hour, and with 450 volts at the motors.

Oerlikon Motor-generator Type of Single-phase Locomotive with Continuous-current Driving Motors.

Prior to the construction of the above-described single-phase locomotive, with single-phase commutator motors, the Oerlikon Co. had been developing a single-phase system of traction in which the locomotive is equipped with a motor-generator

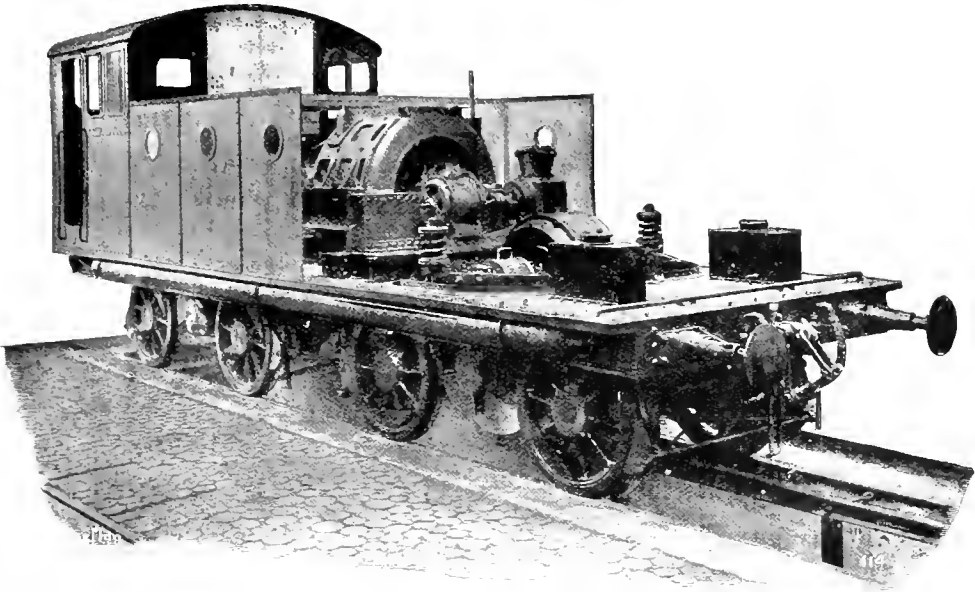

Fig. 316. OERLIKON HIGH-VOLTAGE SINGLE-PHASE LOCOMOTIVE OF THE MOTOR GENERATOR TYPE.

set comprising a single-phase motor directly connected to a continuous-current generator, from which continuous-current motors driving the axles are supplied with power. The system is often designated as the Ward-Leonard system. Some years ago H. Ward-Leonard clearly promulgated the proposition to

“ Vary the voltage as the speed desired,
Vary the current as the torque required.”

A photograph of a single-phase Oerlikon locomotive of this type is shown in Fig. 316. This locomotive is designed for a continuous output of 400 h.-p. and for a speed of 37 miles per hour. Fig. 317 contains drawings of this locomotive showing the outlines of the motor-generator set, located in the body of the locomotive and of

ELECTRIC RAILWAY ENGINEERING

the two continuous-current motors, which communicate their power, first through single reduction gearing and then through cranks and connecting rods, to the driving wheels.

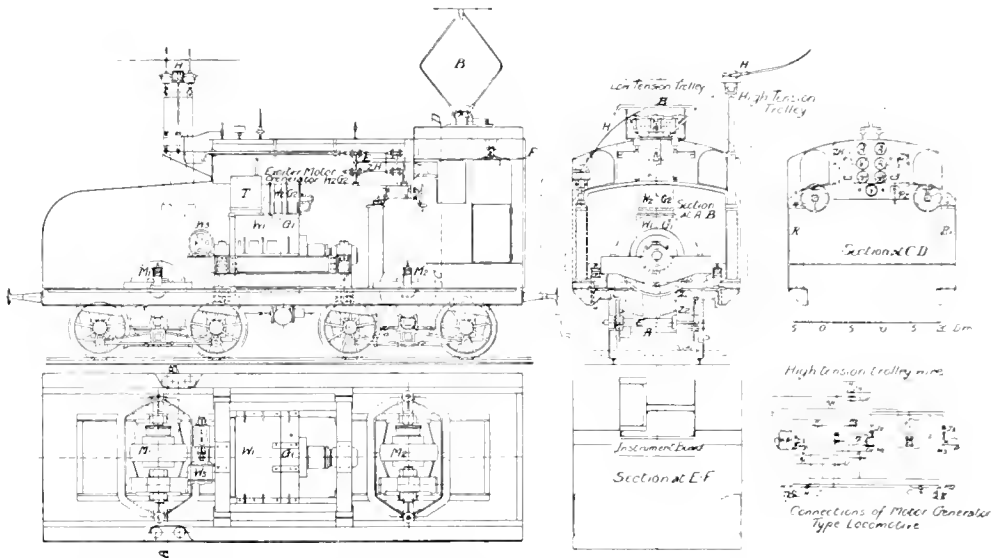

Fig. 317. HIGH-VOLTAGE SINGLE-PHASE MOTOR GENERATOR TYPE OERLIKON LOCOMOTIVE.

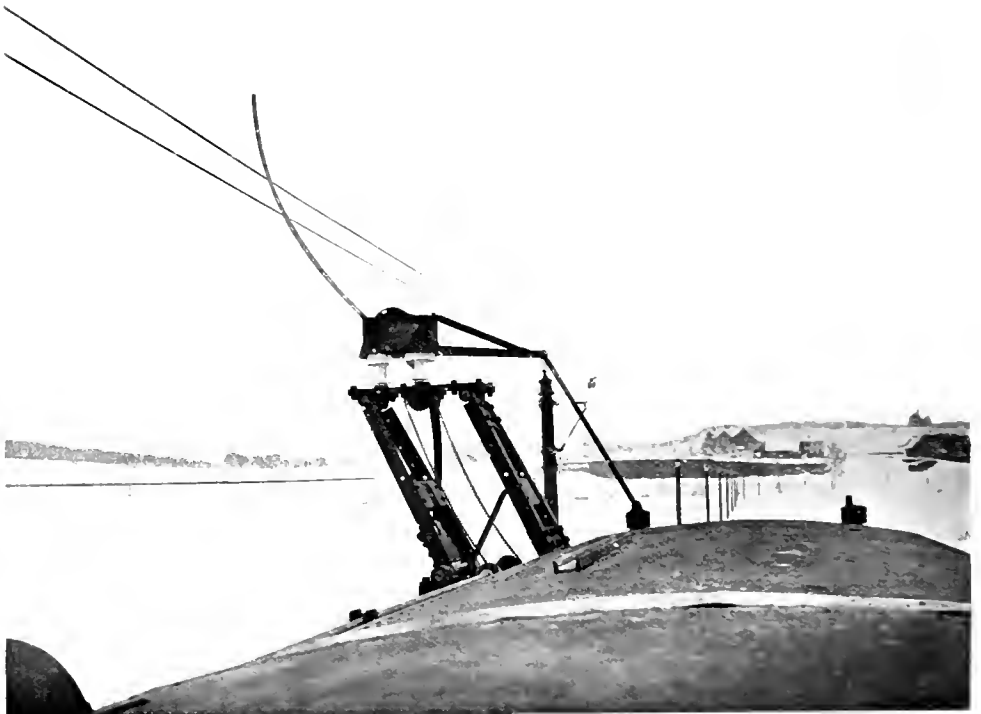

Fig. 318. OERLIKON TROLLEY.

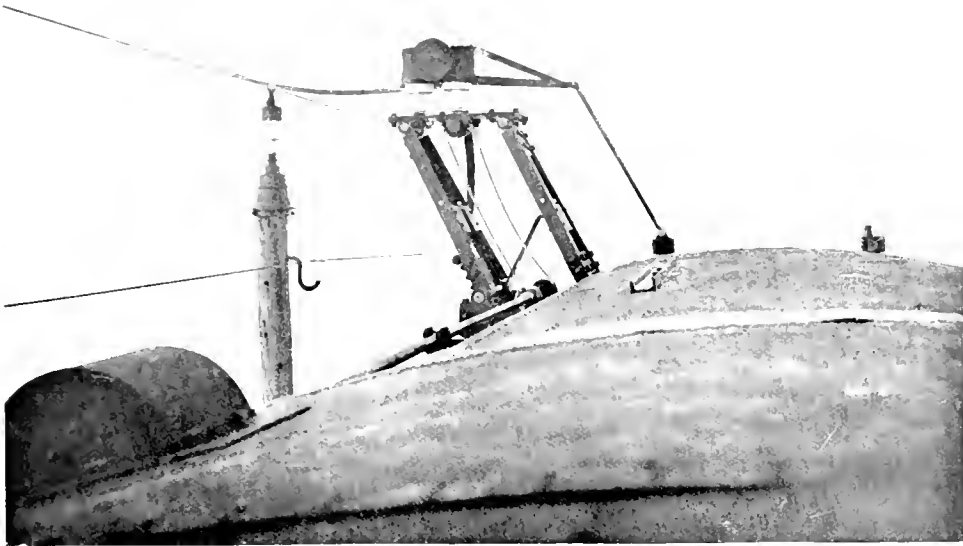

Fig. 319. OERLIKON TROLLEY.

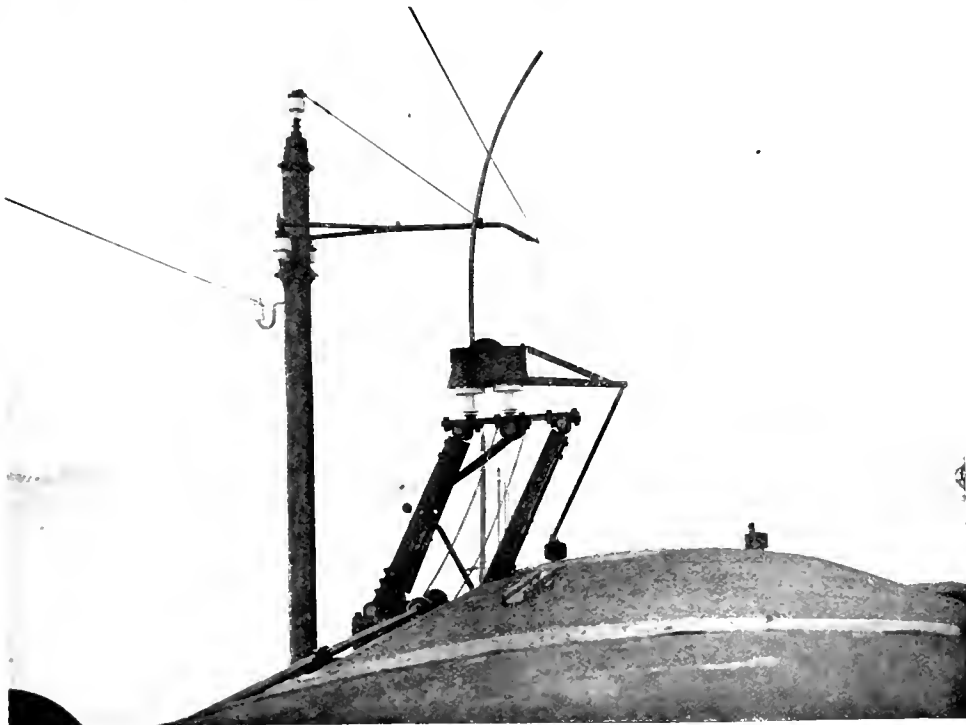

Fig. 320. OERLIKON TROLLEY.

ELECTRIC RAILWAY ENGINEERING

In types for higher speeds, the reduction gearing is omitted. The current is collected from the overhead wire at any voltage up to 15,000 volts, by the Oerlikon overhead trolley, shown in Figs. 318 to 322. For trolley pressures below 6,000 volts, the current is then led to a single-phase motor, generally of the non-synchronous type. For pressures of 6,000 volts and upwards, a step-down transformer is carried on the locomotive, the stator of the single-phase motor being wound for low potential corresponding to the secondary winding of the step-down transformer. A secondary pressure of 700 volts has generally been employed by the Oerlikon Co. in such cases.

The locomotive illustrated in Figs. 316 and 317 has a weight of 44.1 metric tons



Fig. 321. OERLIKON TROLLEY.

when the single-phase motor is wound for the full line potential. Of this weight the electrical equipment constitutes 25.1 metric tons. When a transformer is employed in order to step down from 15,000 volts to 6,000 volts, the weight of the electrical equipment is increased to 27.7 metric tons, and the complete weight of the locomotive is then 46.7 metric tons.

Siemens & Halske High Speed 10,000-volt Three-Phase Locomotive.

It will be convenient at this point to digress from the question of geared *versus* gearless motors in order to describe another notable instance of an extra-high voltage locomotive. In order to operate the driving motors direct from the extra-high voltage

LOCOMOTIVES AND MOTOR CARRIAGES

trolley line and to thus save the weight and expense of step-down transformers, it becomes inexpedient to locate the motors under the trucks of motor cars. It is distinctly advantageous in such cases to mount the motors on a locomotive and to keep all electric circuits away from the remainder of the train. In Figs. 323 and 324 is illustrated a Siemens & Halske high speed locomotive equipped with four 250 h.-p. three-phase induction motors wound direct for 10,000 volts. While the drawings show four motors, two on each truck, only two motors appear to have been actually built, and the tests were run with but these two motors.

The locomotive, which, with its equipment of two motors, weighs 40 metric tons, has hauled a carriage of 31 tons weight on the level at a speed of 65 miles per hour. Winding the motors direct for 10,000 volts, while it makes the motors large and heavy for their output, nevertheless considerably reduces the weight of the electrical equipment below that of an equipment with step-down transformers and low-voltage motors.

The locomotive is equipped with two 10,000-volt, three-phase, six-pole induction motors. For a line periodicity of 45 cycles per second, the corresponding synchronous speed of the motors is 900 revolutions per minute. Other data are given below:—

Driving wheel diameter = 49 ins.
 Number of teeth in gear = 147.
 pinion = 69.
 Gear ratio = 2.13:1.

From this we find that the corresponding speed of the locomotive is 66 miles per hour. There is, of course, a slip varying with the load. In the motor in question, this involves a loss of speed of 11 per cent. when the output per motor is at the maximum 45-cycle 10,000-volt value of 400 h.-p. The predetermined characteristic curves of the motor corresponding to 10,000 terminal volts and a periodicity of 45 cycles per second are given in Fig. 325. From these curves we find that the slip at 350 h.-p. output per motor is

$$\frac{900 - 845}{900} \times 100 = 6.1 \text{ per cent.}$$

Drawings of the motor are given in Figs. 326, 327, and 328. A photograph of the wound stator is shown in Fig. 329, and a photograph of the motor assembled complete, with gears and gear cases, in Fig. 330. Gears are employed at both ends of each

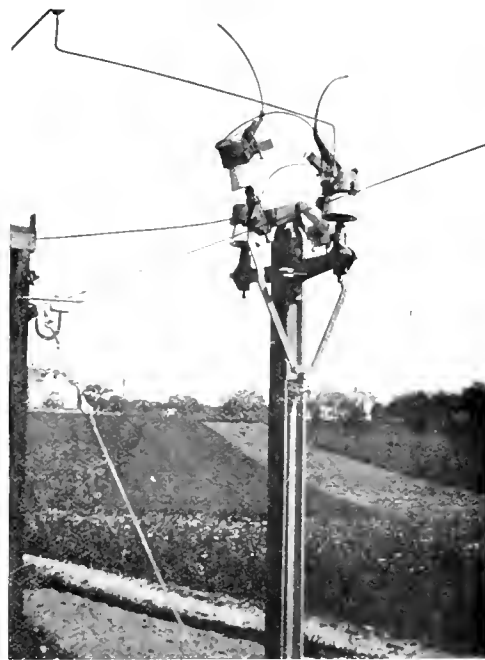

Fig. 322. OERLIKON OVERHEAD HIGH TENSION SWITCH.

ELECTRIC RAILWAY ENGINEERING

motor, owing to the large amount of power transmitted and to the high speed of the gear teeth. At a locomotive speed of 65 miles per hour, the speed at the pitch line of the gear teeth is 23 miles per hour. The diameter at the gear pitch line is 34.5 ins. This high speed requires special provision for lubrication. The means adopted consists in throwing the oil in several jets between the teeth at the entering side by the use of a low air pressure.

The motor has a gap diameter of 26.8 ins., and a gross core length of 11.8 ins. The internal dimensions of the bearings are 12 ins. length by 4 ins. diameter. These

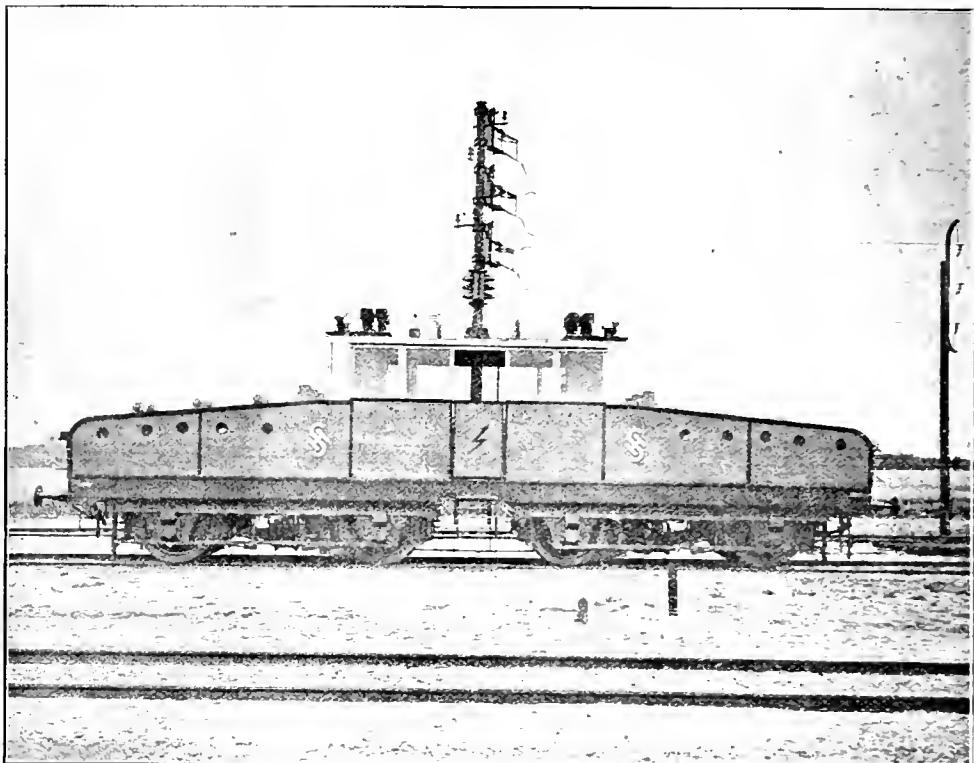

Fig. 323. SIEMENS AND HALSKE HIGH SPEED LOCOMOTIVE, WITH 10,000-VOLT THREE-PHASE MOTORS.

liberal proportions permit of employing a clearance at the air gap of only 0.07 ins. between rotor and stator. The bearings are of bronze, lined with white metal, and the lubrication is by means of oil and wicks.

The Y-connected 10,000-volt winding is placed on the stator, as shown in Fig. 329, and consists of 36 form-wound coils of 67 turns per coil, assembled in 72 slots. There are thus 4 stator slots per pole per phase. The slot insulation consists of tubes of mica. Great reticence is for some reason observed with regard to the thickness of the slot insulation of these motors. This winding is stated to have withstood an insulation test of 22,000 volts from copper to iron.

The rotor winding is a Y-connected wave winding consisting of 4 bars per slot in 90 half-closed slots. There are thus 5 slots per pole per phase. Two of the terminals

LOCOMOTIVES AND MOTOR CARRIAGES

of the rotor winding are carried to the two collector rings shown in Fig. 326, and the remaining terminal is grounded to the core of the rotor. At starting, the pressure in the rotor winding is 700 volts between terminals. The rotor end connections are secured against centrifugal force by bronze caps, as shown in Fig. 326.

Each motor weighs 4.1 metric tons.

Fig. 331 gives a diagram of the electrical connections which were employed. At starting, and for speed regulation, rheostats are employed in series with the rotor windings. These rheostats are of the metallic type, and are subdivided into 24 steps.

Exclusive of electrical equipment, the weight of the locomotive is 24 metric tons.

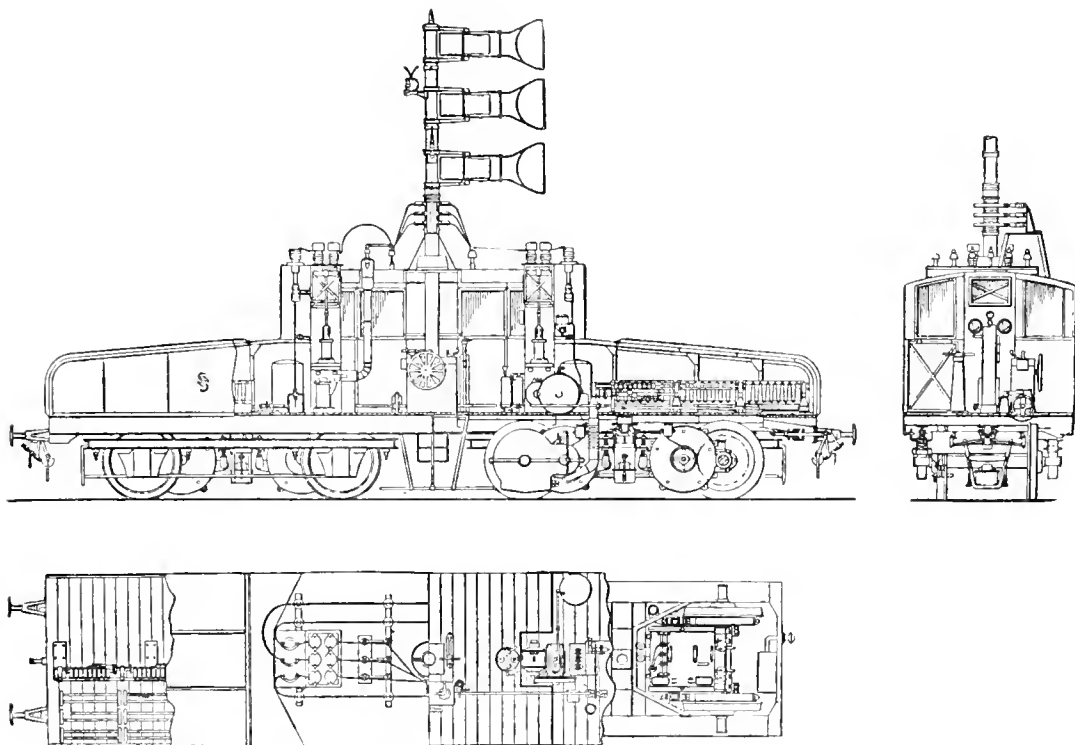

Fig. 324. SIEMENS AND HALSKE HIGH SPEED LOCOMOTIVE, WITH 10,000-VOLT THREE-PHASE MOTORS.

The total weight of the electrical equipment amounts to 16 metric tons. This gives a total weight of 40 metric tons for the locomotive equipped with two motors and accessories. Had it been equipped with its full complement of four 4.1-ton motors instead of with only two such motors, the weight, with a reasonable allowance for increased weight of auxiliary electrical gear, would have been increased to about 58 tons, or say

Non-electrical equipment	=	24 metric tons.
Electrical	=	28

The weight of the electrical equipment would thus have constituted some 54 per cent. of the total weight of the locomotive.

The published reports of the tests on this locomotive are disappointingly vague.

ELECTRIC RAILWAY ENGINEERING

They consist in stating that from June 17th to 26th, 1902, the voltage and periodicity were increased in successive tests, beginning with some 25 cycles and 6,000 volts, and

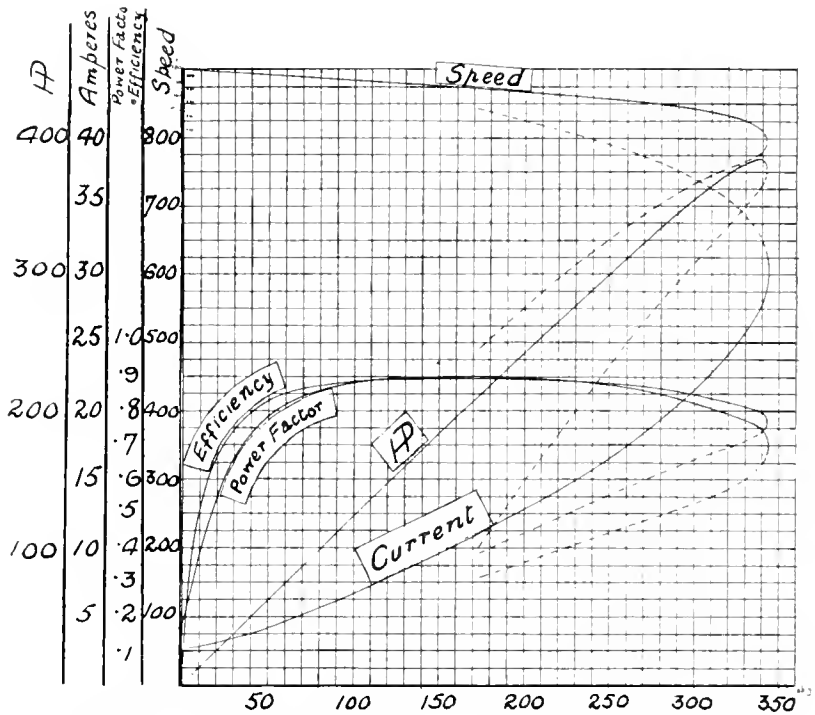

Fig. 325. CHARACTERISTIC CURVES OF 10,000-VOLT MOTORS OF THE SIEMENS AND HALSKE LOCOMOTIVE.

runs were made at speeds of from 34 to 62 miles per hour. The last test was made June 26th, 1902, with 11,000 volts and a periodicity of 42.5 cycles per second, when a railway carriage of 31 tons weight was hauled. A maximum speed of 65 miles per hour was attained. It is stated that it was found that the gearing still ran fairly quietly, and that the motors operated fairly satisfactorily. It is stated that the locomotive and trailer both ran smoothly. The energy consumption was about 260 kilowatts. This corresponds to an output of about 280 h.p. at the rims of the driving wheels. The locomotive was found to be able to start from rest when hauling a load of some 90 tons, making, with its own weight, a train weight of 130 tons.

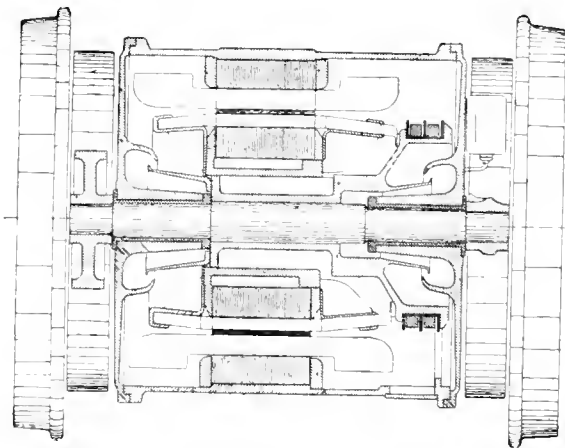

Fig. 326. SIEMENS AND HALSKE 10,000-VOLT THREE-PHASE MOTOR.

LOCOMOTIVES AND MOTOR CARRIAGES

The chief object of the tests was to demonstrate the practicability of employing polyphase motors wound directly for 10,000-volts pressure. It is, however, highly

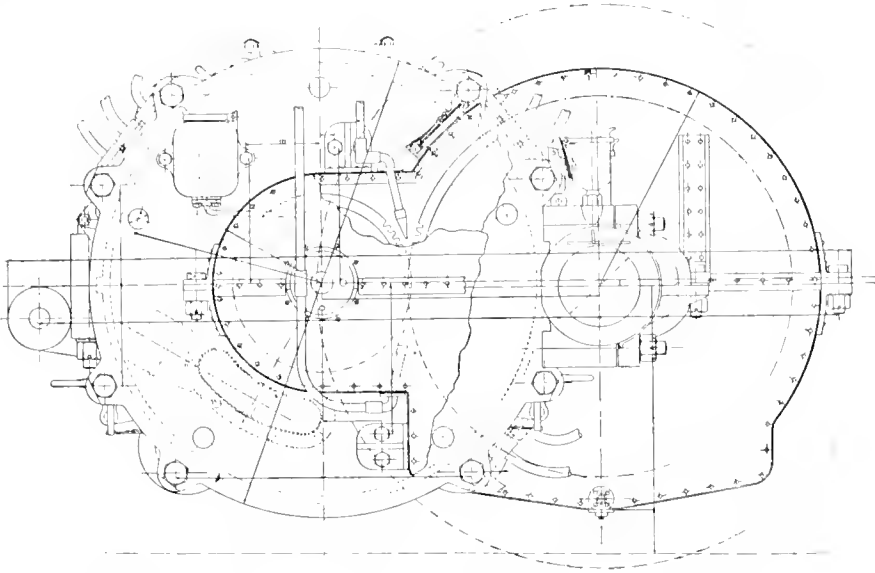

Fig. 327. SIEMENS AND HALSKE 10,000-VOLT THREE-PHASE MOTOR.

improbable that the use of 10,000-volt trolley lines will become necessary even in extensive railway projects. The heaviest work can be very satisfactorily and economically carried out with from 3,000 to 6,000 volts at the trolley. Nor is it at

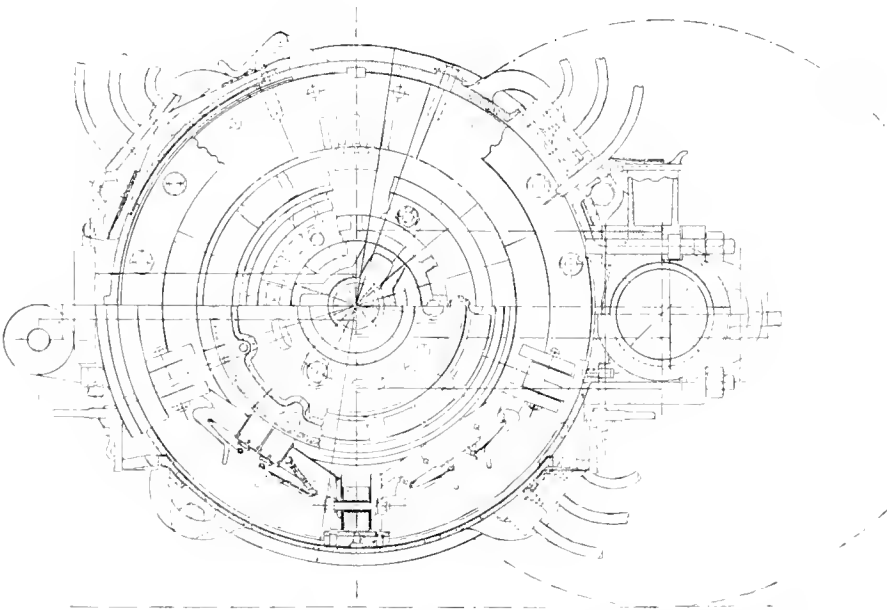

Fig. 328. SIEMENS AND HALSKE 10,000-VOLT THREE-PHASE MOTOR

ELECTRIC RAILWAY ENGINEERING

all improbable that high trolley voltage will be combined with the use of continuous current motors. The practicability of such a plan has been maintained by various authorities. In 1904, one of the writers worked out such a scheme in order to make a comparison with a high voltage single-phase scheme.¹ The result was distinctly in favour of the high voltage continuous-current system.

At that time the proposition met with no encouragement. High voltage continuous current for traction is, however, now advocated by F. J. Sprague,² who has expressed himself as follows:—

“On the general subject of alternating current and continuous-current operation, I beg to add a word. Affecting, as it vitally does, conductor capacity and sub-station distances, it is unfortunate that Mr. Scott should make a statement to the effect that 500 volts had become

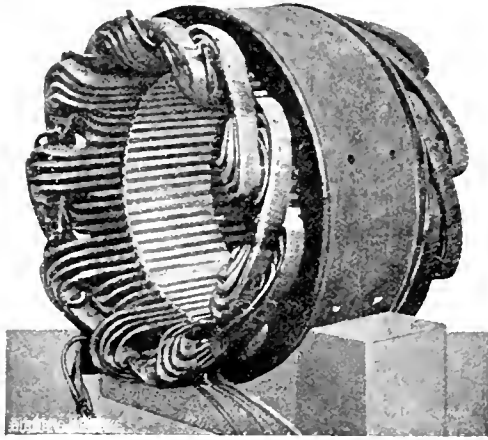

Fig. 329. STATOR OF 10,000-VOLT SIEMENS AND HALSKE THREE-PHASE MOTOR.

the standard, and, by inference, must necessarily be the limit for continuous-current operation, for although the New York Central's rail supply will be at 650 volts, its continuous-current motors are guaranteed for 750, the Berlin Elevated and the Zweisimmen-Montreux roads are built for 800 to 850; reliable companies in Europe are supplying continuous-current motors wound for 1,000 volts, and it may be safely assumed that, in spite of apparent difficulties, turbine operation of comparatively high voltage continuous-current dynamos is not an impossibility.”

Two months later in a letter to the *Street Railway Journal*,³ Sprague again takes this matter up, and concludes his communication as follows:—

“To that end I beg, therefore, to announce that if in any case, after considering the various kinds of equipment

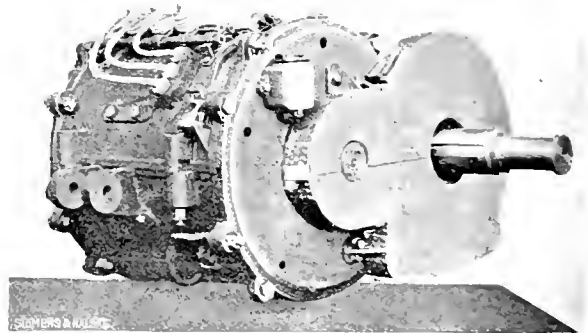

Fig. 330. SIEMENS AND HALSKE 10,000-VOLT THREE-PHASE MOTOR.

¹ “The Continuous-current System and the Single-phase System for Traction,” H. M. Hobart, *Electrical Review*, Vol. LIV., pp. 693—695, April 29th, 1904, and pp. 765—767, May 6th, 1904. See also “Interurban Electric Traction Systems: Alternating versus Direct Current,” P. M. Lincoln, *Electrical World and Engineer*, Vol. XLII., pp. 951—955, December 12th, 1903; discussion *re* above articles, *Electrical Review*, Vol. LIV., pp. 1031—1033, June 24th, 1904.

² “An Unprecedented Railway Situation,” *Street Railway Journal*, Vol. XXVI., pp. 775, 776, October 21st, 1905.

³ P. 1089, December 23rd, 1905.

LOCOMOTIVES AND MOTOR CARRIAGES

possible, it should seem from an analysis of all elements entering into the problem that a comparatively high potential continuous-current equipment would produce the

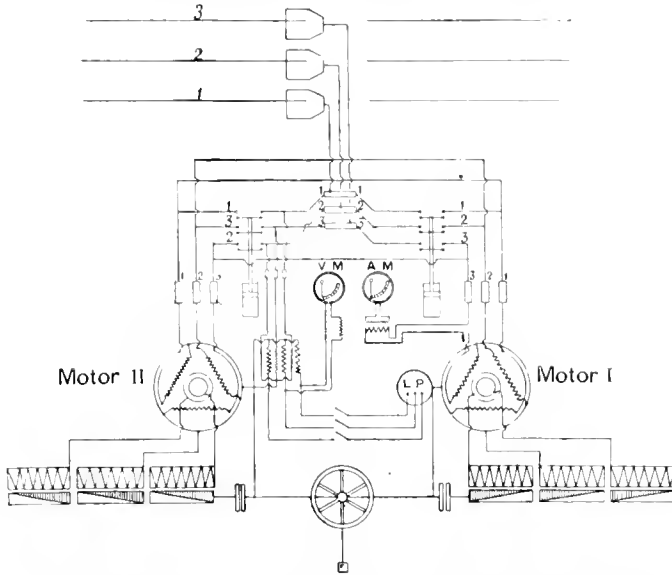

Fig. 331. DIAGRAM OF ELECTRICAL CONNECTIONS OF SIEMENS AND HALSKE 10,000-VOLT THREE-PHASE LOCOMOTIVE.

best net results, I am prepared to engineer and carry to a successful conclusion a continuous-current installation at a working pressure, even on a third rail, of not less than 1,500 volts, which is at least two and a-half times that ordinarily used.

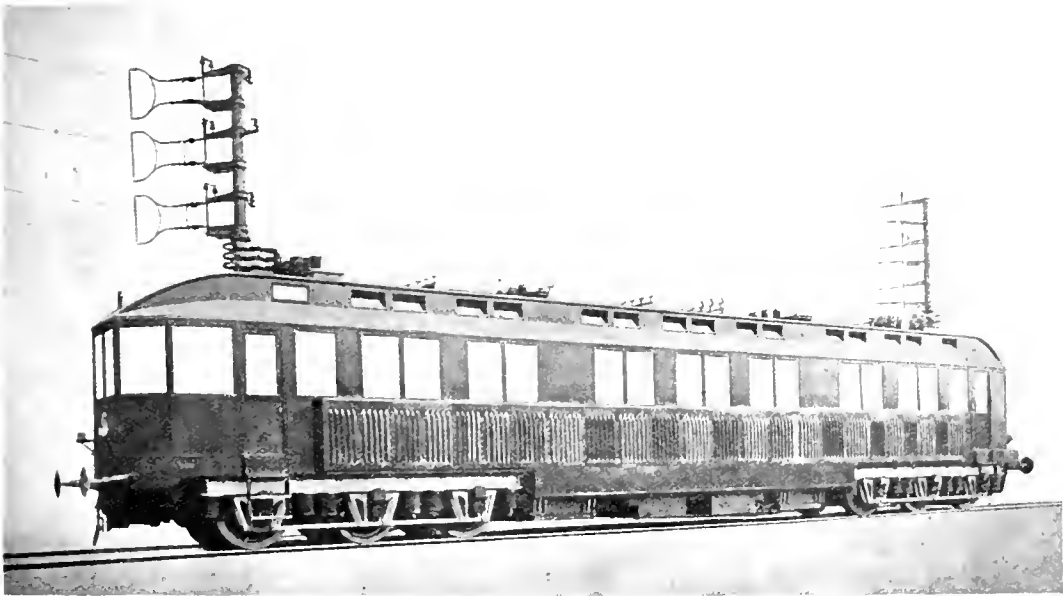

Fig. 333. SIEMENS AND HALSKE HIGH SPEED ZOSSEN MOTOR CAR.

ELECTRIC RAILWAY ENGINEERING

"I believe that it may be admitted that, although I have oftentimes taken a somewhat radical and advanced position in electric railway matters, I have never made a public proposal which I have not been ready, when called upon, to carry out, and should conditions arise warranting an equipment such as is proposed, I propose to establish a new and necessary comparative standard in equipment possibilities; and I venture further to affirm that 1,500 volts is not the limit of practical continuous-current operation."

In view of this, and of support from other quarters, it is evident that the subject of higher voltage for continuous-current traction will now be taken up with more enterprise than has heretofore been displayed by electrical manufacturers, and the advocates of single-phase traction will no longer be able to confine their comparisons to high tension alternating current voltages on the one hand and 500-volt continuous-current third rail voltages on the other.

S. & H. and A.E.G. High Speed Zossen Motor Cars.

In the principal tests carried out at Zossen in 1903, two motor cars were used. These two cars were built respectively by the firms of Siemens & Halske and the

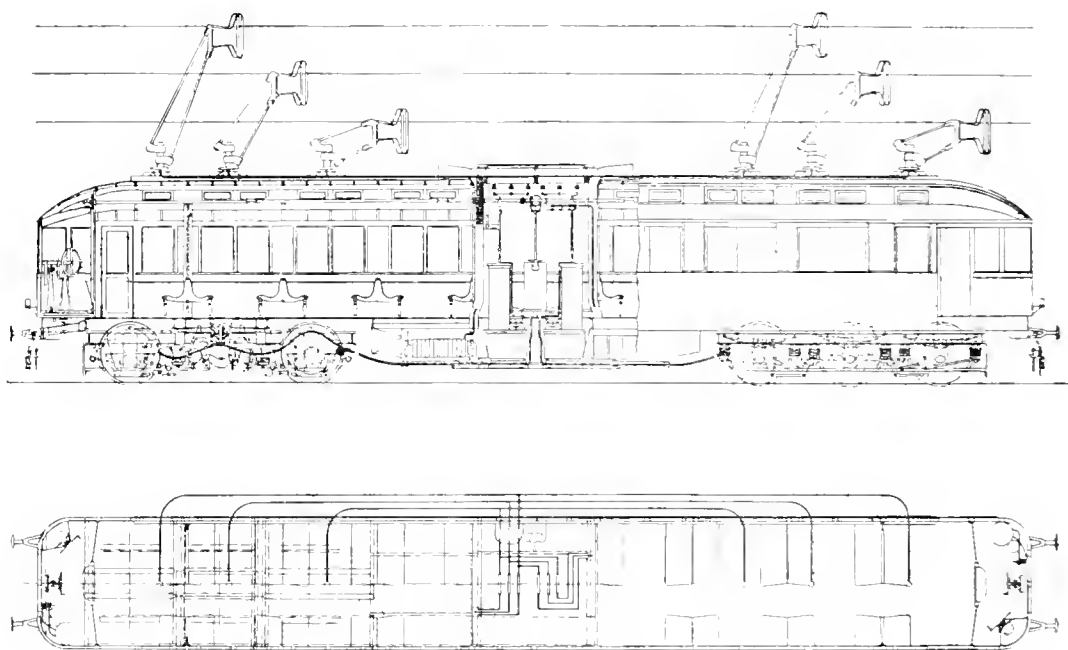

Fig. 334. A.E.G. HIGH SPEED MOTOR CAR.

Allgemeine Elektrizitäts Gesellschaft. The former is illustrated in Figs. 332 and 333, and the latter in Figs. 334 and 335. In each case the equipment consisted of four gearless three-phase motors of a normal rating of 250 h.-p. per motor, and a maximum output of 750 h.-p. per motor. These motors were supplied from the secondaries of step-down transformers carried on the car. The primary current during

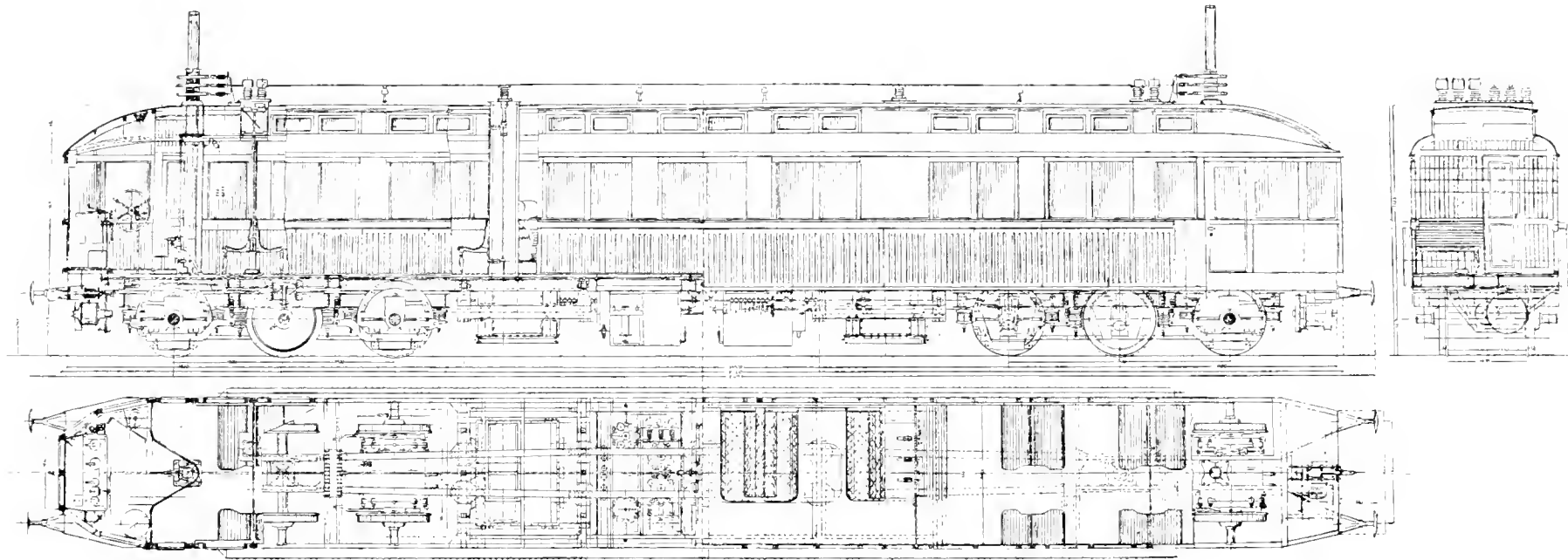

Fig. 332. SIEMENS AND HALSKE HIGH SPEED ZOSSEN MOTOR CAR.



LOCOMOTIVES AND MOTOR CARRIAGES

the extra high speed tests was of a periodicity of 50 cycles per second at a pressure of 10,000 volts. The S. & H. car had a complete weight of 77 metric tons, and

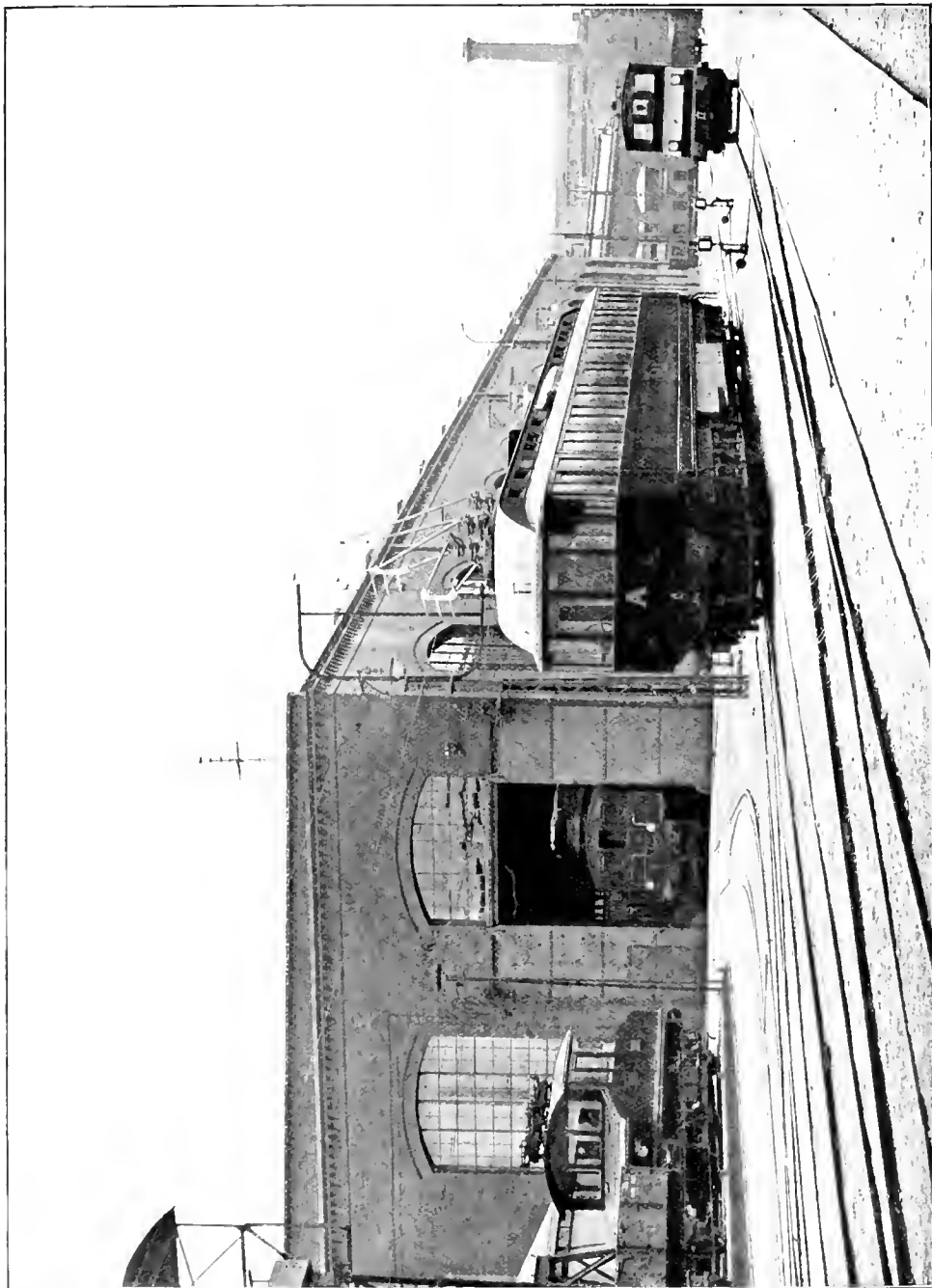

Fig. 355. ALLGEMEINE ELEKTRICITÄTS-GESELLSCHAFT HIGH SPEED MOTOR CAR USED IN BERLIN ZOSSEN TRAILS.

employed a secondary pressure of 1,150 volts at the slip rings of the rotors which carried the motor's primary winding. The A.E.G. car weighed 90 metric tons, and

ELECTRIC RAILWAY ENGINEERING

employed a secondary pressure of 435 volts at the terminals of the motor's primary windings, which, in their design, were located on the stator. The S. & H. motors weighed 3.2 metric tons each, and the A.E.G. motors weighed 1.1 metric tons each. The driving wheels of both cars were of 49.2 ins. (1,250 mm.) diameter.

Considerable confusion exists as regards the weight of these cars. As originally constructed the Siemens and Halske car weighed some 77 tons, to judge from statements appended to a number of the test curves. To the A.E.G. car a weight of some 90 tons is ascribed in most instances. The tests extended over several years (1901 to 1903), and in consequence of structural modifications made

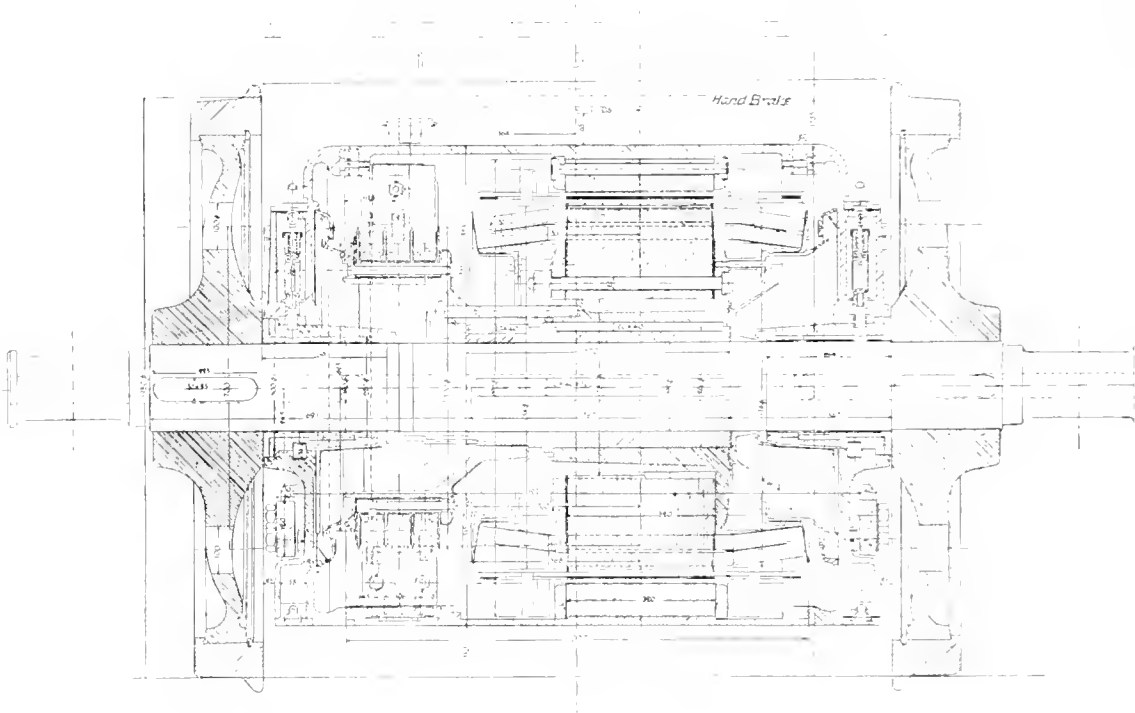

Fig. 336. S. & H. MOTOR FOR HIGH SPEED ZOS-EN MOTOR CAR.

during this period, the weights of both cars are generally quoted as some 93 tons during the latest tests. This increased weight may, however, be partly ascribed to the weight of the personal and to the artificial load, these factors being different on different occasions.

The S. & H. motors were mounted rigidly upon the driving axes, as shown in Fig. 336, while the A.E.G. motors were mounted on a hollow shaft and were spring supported from the driving wheels, as may be seen from the drawing in Fig. 337. Fig. 338 is a photograph of the spring supporting gear.

Fig. 339 shows a photograph of the S. & H. rotor rigidly mounted on the shaft, and carrying the primary winding, and Fig. 340 shows a photograph of the A.E.G. rotor mounted on a hollow shaft and carrying the secondary winding. Fig. 341 shows

ELECTRIC RAILWAY ENGINEERING

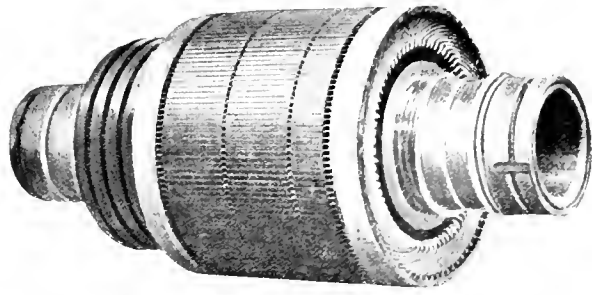

Fig. 340. ROTOR OF MOTOR OF A.E.G. ZOSSEN MOTOR CAR.

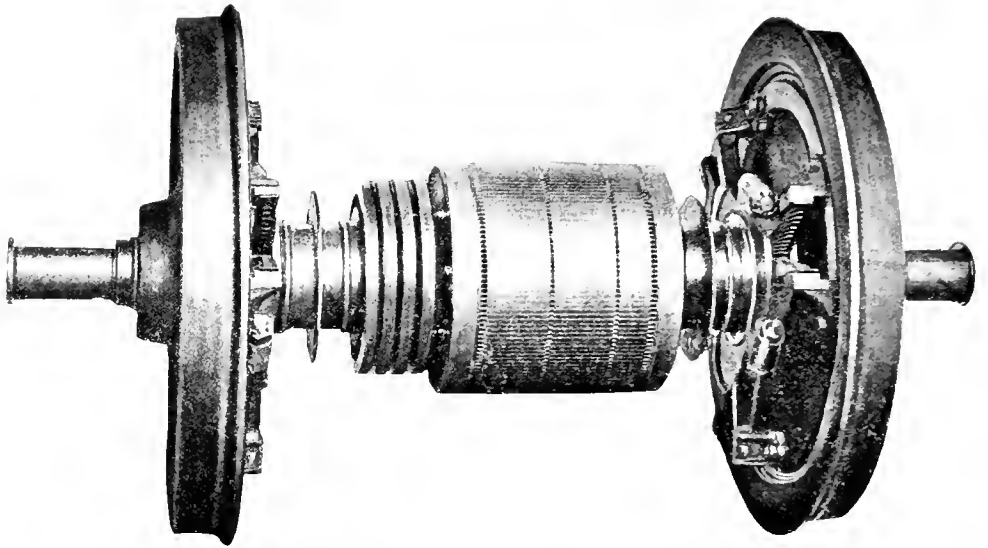

Fig. 341. ROTOR OF MOTOR OF A.E.G. ZOSSEN CAR IN PLACE ON AXLE.

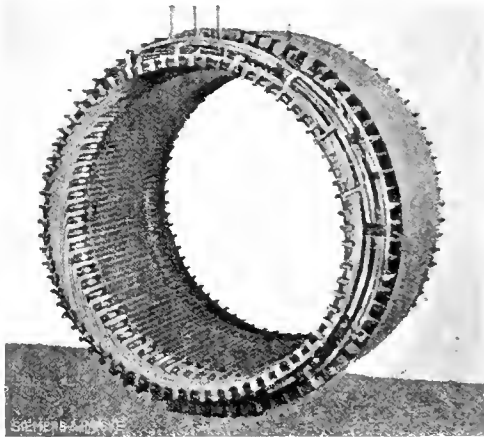

Fig. 342. STATOR CORE AND SECONDARY WINDING OF MOTOR OF S. & H. ZOSSEN MOTOR CAR.

LOCOMOTIVES AND MOTOR CARRIAGES

a photograph of the latter rotor in place on the axle. Here again the method of spring support from the driving wheels may be seen. A photograph of the S. & H.

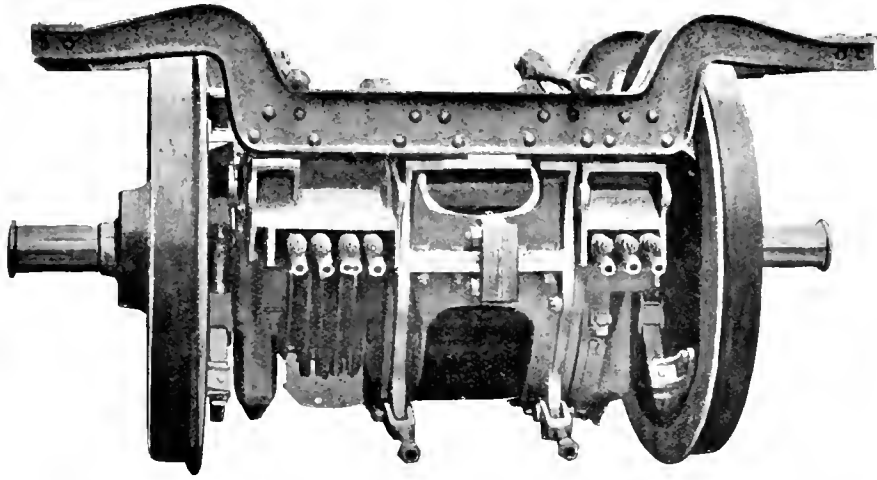

Fig. 343. ASSEMBLED MOTOR OF A.E.G. HIGH SPEED ZOSSEN MOTOR CAR.

stator core and secondary winding is shown in Fig. 342. An assembled A.E.G. motor is shown in the photograph in Fig. 343.

ROLLING STOCK FOR MONO-RAIL TRACTION SYSTEMS.

The writers are of opinion that, so far as there is any future for mono-rail traction, somewhat better prospect of success rests with systems designed for underslung rolling stock. The Langen mono-rail system falls under this heading, and has already undergone a certain amount of practical development. In the space at our disposal it will be necessary to forego any complete description of this very interesting system.

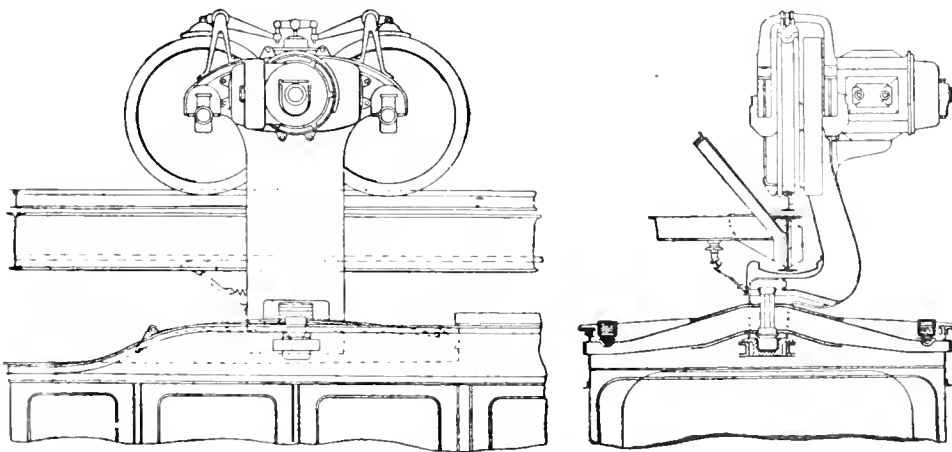

Fig. 344. METHOD OF SUSPENDING CARRIAGE OF LANGEN MONO-RAIL SYSTEM.

LOCOMOTIVES AND MOTOR CARRIAGES

of the centrifugal force. As the passengers are subject to the same force, they do not experience any disturbance. Indeed, it is claimed that they are not able to ascertain

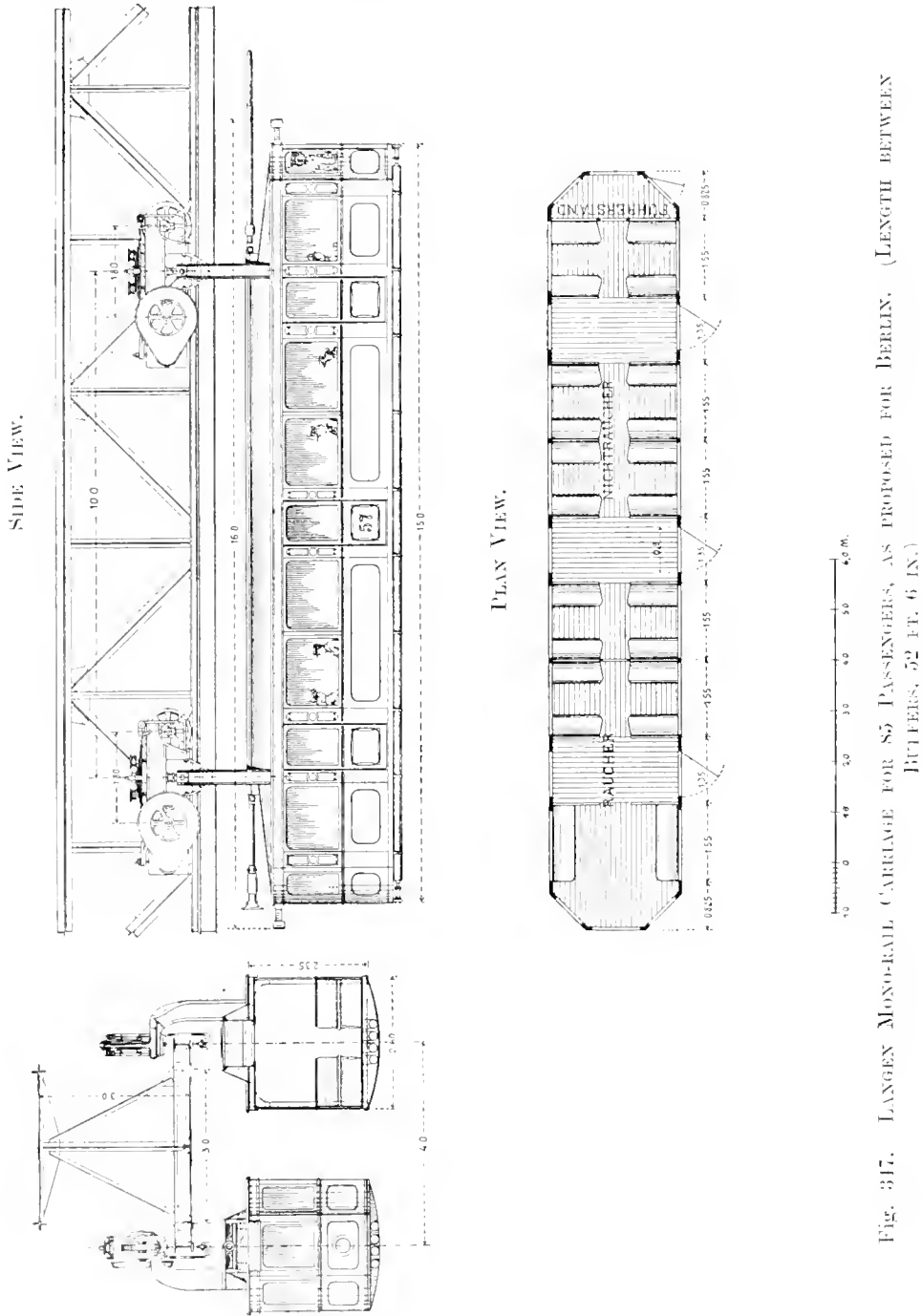

Fig. 317. LANGEN MONORAIL CARRIAGE FOR 85 PASSENGERS, AS PROPOSED FOR BERLIN. (LENGTH BETWEEN BUFFERS, 52 FT. 6 IN.)

whether the car is running on a curve or on a straight line unless they look out through the windows.

ELECTRIC RAILWAY ENGINEERING

Fig. 344 shows drawings of the suspension of a carriage. The suspension is designed to prevent the carriage from leaving the rail under any circumstance.

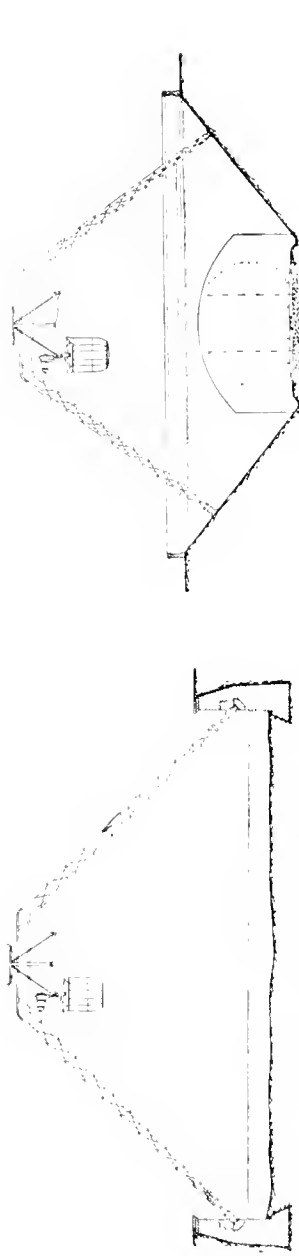

Fig. 348. DESIGNS OF LANGEN MONO-RAIL SYSTEM OVER A RIVER.

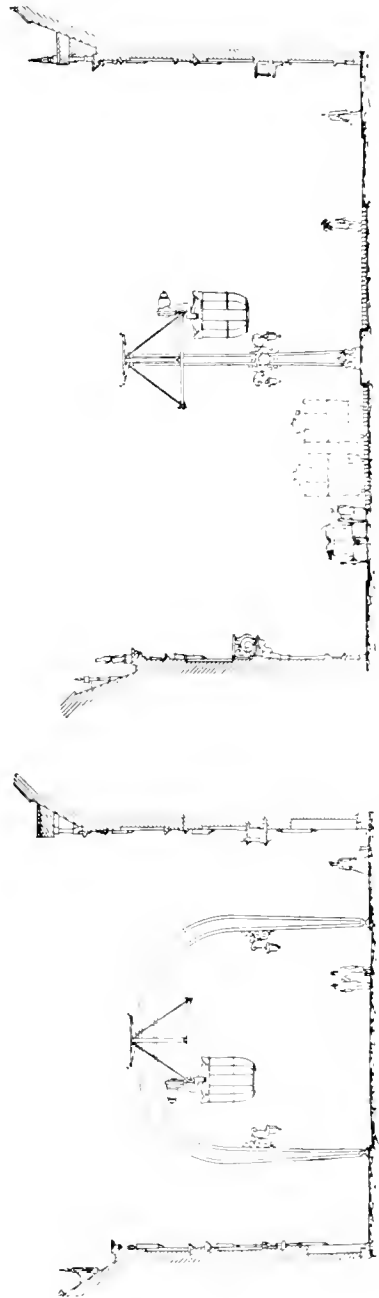

Fig. 349. DESIGNS OF LANGEN MONO RAIL SYSTEM OVER A STREET.

Fig. 345 gives the transverse and longitudinal sections of the carriages working at Elberfeld, and Fig. 346 shows one of the terminal stations.

The principal data of these carriages are given in Table CVI.

LOCOMOTIVES AND MOTOR CARRIAGES

TABLE CVI.

Principal Data of a Carriage of the Langen Mono-rail System.

Length between buffers	39 ft. 5 in.
Width	7 ft. 4 in.
Distance between the axles of the bogies	22 ft. 6 in.
Distance between the wheels of a bogie	3 ft. 9 in.
Weight of a completely equipped car with all seats occupied	16 tons
Seating capacity	48 passengers

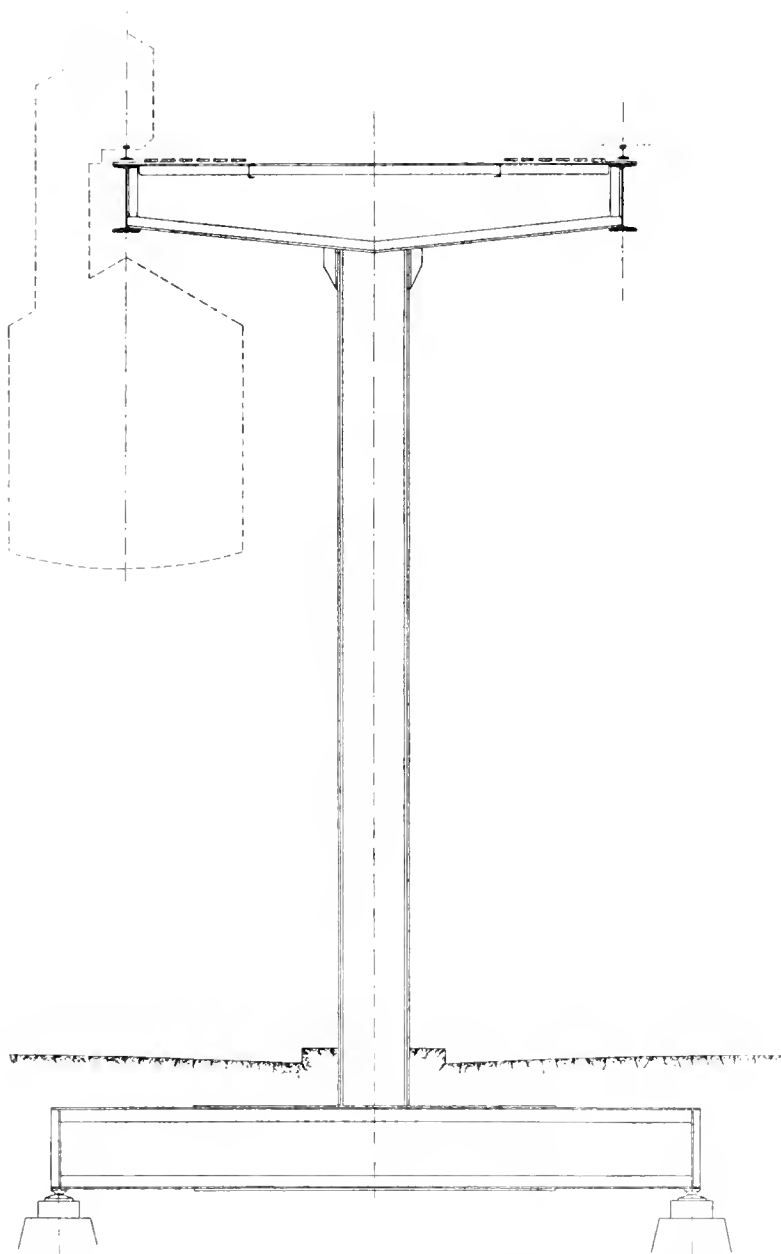

Fig. 350. SUPPORTING STRUCTURE FOR THE BERLIN PROJECT FOR A LANGEN MONO-RAIL SYSTEM (SCALE, 1:50).

ELECTRIC RAILWAY ENGINEERING

The carriages at Elberfeld are each equipped with two continuous-current 600-volt motors with a capacity of 35 h.-p. each. It is, however, only during acceleration that the motors are required to develop their rated load: at an average speed of 24 miles per hour the required power amounts to 23 h.-p. for each motor.

The cars which were proposed for a projected railway for Berlin, as shown in Fig. 347, were designed for a capacity of 85 passengers each, and for a maximum speed of 31 miles per hour. For this project, the schedule speed works out at about 18.5 miles per hour, and the average distance between stops is about half a mile. The loaded weight per car was estimated as 24 tons, and each was to be equipped with two motors of a maximum capacity of 100 h.-p. per motor.

The rails are carried by a framework resting on iron supports of suitable form, which is, of course, varied in accordance with the construction of the line, as regards crossing over existing railways, tramways or rivers or public roads, or whether it must pass into a brick tunnel or an iron tube.

The framework of the railway is so constructed as to involve a minimum of obstruction of light for the streets. The cars operate very smoothly and quietly.

Fig. 348 and Fig. 349 show the sections of the railway as projected to pass over a river and over a street. Both forms were employed on the Barmen-Elberfeld-Vohwinkel Railway, and have stood the test of practical use very satisfactorily. The projected railway for Berlin was to be made as far as practicable on the lines of a quite different design, as shown in Fig. 350. On this plan, two beams with a sway-bracing between them are substituted for the framework.

The station platforms are usually only about 16 feet above ground level, and lifts are therefore not necessary.

It is stated that on curves of not less than 250 feet radius, the resistance does not exceed that on straight lines, and that as a consequence the power required for maintaining a given schedule speed is considerably lower than on other railways. It is also stated that sharp curves may be traversed at a speed more than twice as high as with standard railways.

A STUDY OF THE RELATIVE WEIGHTS AND COSTS OF GEARLESS AND GEARED EQUIPMENTS.

The question of gearless *versus* geared motors involves a consideration of the relative weights and costs of the two equipments, aside from the weight and cost of the remainder of the locomotives. It also involves questions of design, diameter of driving wheels, etc., owing to the limitations of space available for the motors.¹ In fact, the choice of ratio of gearing is restricted to fairly narrow limits by these and other considerations which we propose to now set forth.

Let us first study the relation of the weight of an electric railway motor to its rated speed and rated capacity. In an article entitled "Heavy Electric Railroading"

¹ For passenger railway carriages with motors on trucks, the diameter of the driving wheel is necessarily small (generally 33 ins.); but in the case of locomotives the diameter of the driving wheel should be determined upon with especial care, and one of the determining factors should be the limitations of space available for the motors.

LOCOMOTIVES AND MOTOR CARRIAGES

on p. 860 of the *Electrical World and Engineer* for November 18th, 1905. Valatin has given interesting data, from which, together with data from other sources, we have deduced the following results.

The "weight coefficient" may be defined as follows:—

Rated horse-power (1-hour 75 degrees Cent. basis)

Weight coefficient = $\frac{\text{Rated horse-power (1-hour 75 degrees Cent. basis)}}{\text{Weight in metric tons (exclusive of gearing)} \times \text{speed in r.p.m.}}$

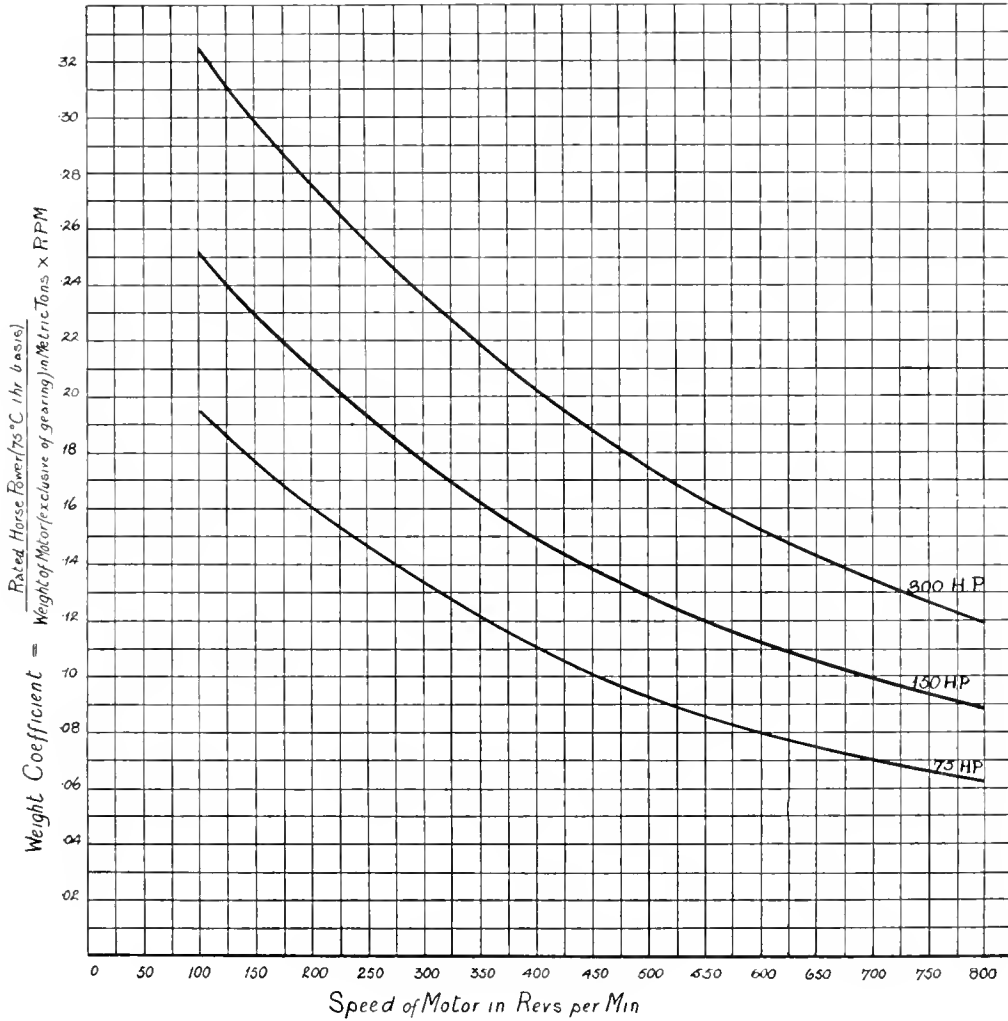

Fig. 351. CURVES SHOWING VARIATION OF WEIGHT COEFFICIENT OF RAILWAY MOTORS, WITH SPEED IN REVOLUTIONS PER MINUTE.

Then for continuous-current railway motors of from 500 to 1,000 volts we have the rough representative values for the weight co-efficient shown in Table CVII.

ELECTRIC RAILWAY ENGINEERING

TABLE CVII.

Weight Coefficients of Continuous Current Railway Motors.

Rated Output in Horse-power.	Weight Coefficient $\frac{\text{Horse-power}}{\text{Metric Tons} \times \text{R.P.M.}}$ for Following Rated Speeds:—			
	200 R.P.M.	400 R.P.M.	600 R.P.M.	800 R.P.M.
75	0.16	0.11	0.080	0.065
150	0.21	0.15	0.11	0.085
300	0.27	0.20	0.15	0.12

The values have been plotted in Fig. 351, which gives curves showing the relation between speed and weight coefficient for motors rated at 75, 150, and 300 h.-p.

This gives us for the total weight of motors, exclusive of gearing, the values shown in Table CVIII.

TABLE CVIII.

Total Weights of Continuous Current Railway Motors, exclusive of Gearing.

Rated Output in Horse-power.	Total Weight of Motor (exclusive of Gearing) in Metric Tons for Following Rated Speeds:—			
	200 R.P.M.	400 R.P.M.	600 R.P.M.	800 R.P.M.
75	2.3	1.71	1.56	1.44
150	3.6	2.5	2.3	2.2
300	5.6	3.8	3.3	3.1

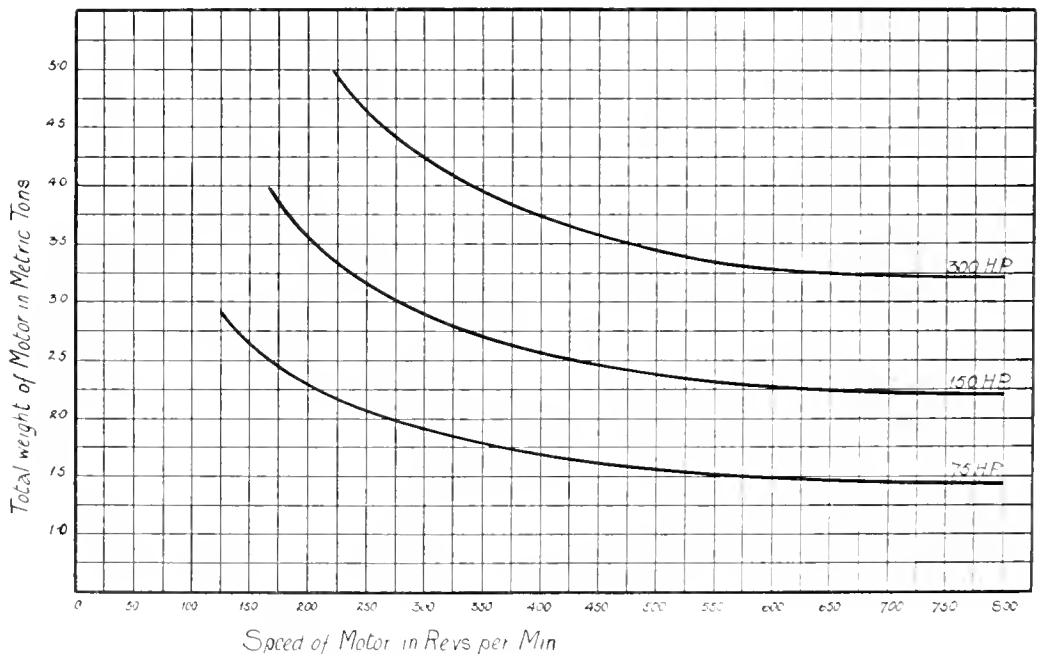

Fig. 352. CURVES SHOWING VARIATION OF THE TOTAL WEIGHT OF RAILWAY MOTORS, WITH SPEED AND REVOLUTIONS PER MINUTE.

LOCOMOTIVES AND MOTOR CARRIAGES

These values have been plotted in Fig. 352, giving curves showing the relation between speed and weight for motors of 75, 150, and 300 h.-p.

Single-phase commutator railway motors will weigh considerably more than the above values, and three-phase railway motors may weigh considerably less.

Valatin's data constitute a valuable source of reference, and are therefore reproduced in Table CIX., by permission :

TABLE CIX.
Valatin's Data for Railway Motors.

Reference Number.	Name of Manufacturer and Type of Motor.	Name of the Line where Motor was used.	Horse-power.	Speed in R.P.M.	Voltage.	Periodicity in Cycles per Second.	Method of Driving.	Weight in Metric Tons.		Wt. Cou. = Rated H.P. (1 hour 75° C. Basis). Wt. in Met. Tons. Exclusive of Gearings. R.P.M.	Source of Data.
								Including Cou.	Excluding Gear.		
1	U. Elek. Gesell. — "G.E. 57"	—	50	580	—	—	Geared	—	1.35	0.064	
2	Westinghouse "56"	—	55	475	—	—	Geared	—	1.360	1.22	0.095
3	Siemens & Halske, D. 17'90"	Berlin Elev. and Subway	60	800	750	—	Geared	1.4	1.57	1.40	0.054
4	Westinghouse "56"	—	75	490	—	—	Geared	—	1.940	1.80	0.085
5	Siemens & Halske, 19/30	—	85	720	750	—	Geared	—	1.750	1.55	0.076
6	General Electric Co.	C.L. Ry. motor car, first type	100	475	500	—	Geared	1:27	—	1.82	0.116
7	Westinghouse "56"	—	150	550	—	—	Geared	—	2.400	2.25	0.121
8	Oerlikon	Freiburg-Musten Line motor car	150	400	750	—	Geared	1.4	3.050	2.70	0.139
9	Gen. Elec. Co., "G.E. 55A"	C.L. Ry., geared loco.	150	500	500	—	Geared	1:7.3	—	2.46	0.122
10	Gen. Elec. Co., "G.E. 56"	C.L. Ry., gearless loco.	170	165	500	—	Direct	—	—	5.42	0.190
11	Siemens & Halske, D. 25/50	—	210	520	—	—	Direct	—	—	4.10	0.098
12	General Electric Co.	N.Y.C. and H.R.R. loco.	550	300	600	—	Direct	—	—	5.0	0.307
13	Oerlikon	Experimental motor	35	1000	290	25	Geared	—	—	1.00	0.035
14	A.E.G. Union, W.E. 31	Stubaithal motor car	40	800	550	40	Geared	1:5.07	—	1.33	0.036
15	Gen. Elec. Co., G.E.A. 604	Schenectady Ballston Line	50	—	290	25	Geared	1:3.74	—	—	—
16	Gen. Elec. Co., G.E.A. 605	Bloomington, Pontiac, and Joliet Line	75	700	290	25	Geared	1:4.3	—	1.9	0.056
17	Siemens-Schuckert	Murhau-Oberammergau	100	530	270	16	Geared	1.5	—	—	—
18	A.E.G. Union	Spindlersfeld Railway	100-120	800	6000	25	Geared	—	2.360	2.10	0.050-0.071
19	Westinghouse	Swedish Govt. loco.	150	1270	200	25	Geared	1:3.88	—	2.50	0.047
20	Oerlikon	Proposed loco.	200	650-1000	—	15	Geared	—	—	3.00	0.103-0.066
21	Westinghouse	Experimental loco.	225	300	140-325	—	Geared	1:5.27	—	—	—
22	Brown-Boveri	Burgdorf-Thun mot. car	60	609	750	40	Geared	1.3	—	1.50	0.066
23	Brown-Boveri	Burgdorf-Thun loco.	150	300	750	40	Geared	1:1.88	—	4.00	0.125
24	Brown-Boveri	Jungfrau loco.	120	750	500	38	Geared	—	—	2.10	0.073
25	Siemens & Halske	Marienfeld - Zossen (250 m. High Speed Railway)	900	1150-1850	45-50	—	Direct	—	—	3.20	0.080-0.240
26	A.E.G.	Marienfeld - Zossen (250 m. High Speed Railway)	900	435	50	—	Direct	—	—	4.08	0.064-0.192
27	Ganz & Co.	Wollersdorf loco.	75	600	3000	42	Geared	1.6	1.440	1.07	0.118
28	Ganz & Co.	Canada motor car	120	750	1100	25	Geared	1:3.27	—	1.75	0.091
29	Ganz & Co.	Port Madoc loco.	180	750	600	50	Geared and driv. comp. rod	1.3	—	1.61	0.140
30	Ganz & Co.	Valtellina old loco.	225	128	3000	15	Direct	—	—	1.90	0.358
31	Ganz & Co.	Valtellina motor car	250	300	3000	15	Direct	—	—	3.80	0.219
32	Ganz & Co.	Proposed loco, Interurban	400	168	2000	14	Comp. rod	—	—	6.95	0.313
33	Ganz & Co.	Proposed motor car Interurban	350	990	3000	30	Geared	1:3.1	2.800	2.55	0.152
34	Ganz & Co.	Proposed loco.	600	225	3000	15	Direct-com.	—	—	6.70	0.308
35	Ganz & Co.	New Valtellina loco, without cascade motor	600	225	3000	15	Comp. rod	—	—	8.15	0.327
36	Ganz & Co.	New Valtellina loco, with cascade motor	450	112.5	3000	15	Comp. rod	—	—	12.40	0.322
37	Ganz & Co.	Italian State Railways	1500	225	—	—	—	—	—	13.10	0.51

ELECTRIC RAILWAY ENGINEERING

One may, for rough preliminary estimates, take the weight, including gear and gear case, at a 15 per cent. higher value than the weights in Table CVIII., although the precise percentage is, of course, a function of the power to be transmitted, the ratio of gearing, and the design of the gear and gear case.

Taking for the present, the weight without gear and gear case and confining our attention to continuous-current railway motors, we may transfer our ideas from weight

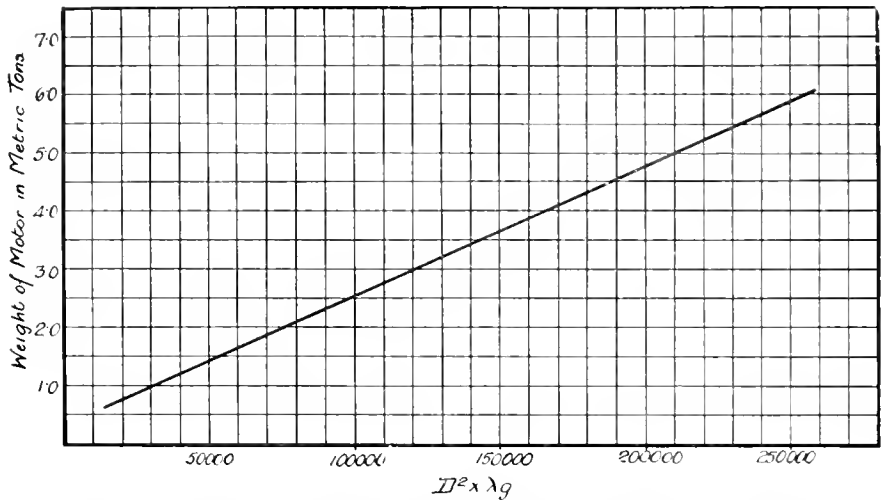

Fig. 353. CURVE SHOWING RELATION OF WEIGHT OF MOTOR IN METRIC TONS TO $D^2\lambda g$ OF ARMATURE FOR CONTINUOUS CURRENT RAILWAY MOTORS.

to volume by a consideration of the curve in Fig. 353. This curve conforms sufficiently to good modern practice to serve our purpose of arriving at the approximate limiting quantities.

$D\delta$ = diameter of armature at air gap in centimetres.

λg = gross length of armature core between end flanges in centimetres.

By means of this curve we may obtain the values set forth in Table CX.

TABLE CX.

Values of $D^2\lambda g$ for Continuous-current Railway Motors.

Rated Output in Horse-power.	$D^2\lambda g$ of Continuous-current Railway Motors for Following Rated Speeds in R.P.M. at Rated Loads. <small>$D\delta$ and λg are expressed in Centimetres.</small>			
	200 R.P.M.	400 R.P.M.	600 R.P.M.	800 R.P.M.
75	91,000	61,000	51,000	50,000
150	115,000	100,000	90,000	85,000
300	235,000	158,000	135,000	123,000

The armature diameter for single reduction geared motors will generally be equal to from 35 per cent. to 65 per cent. of the diameter of the driving wheels. We may take 50 per cent. as a mean value for the purpose of arriving at general

LOCOMOTIVES AND MOTOR CARRIAGES

conclusions. This value will also be fairly representative for gearless motors. For given diameters of driving wheels, and for motors of given weight, we can therefore deduce

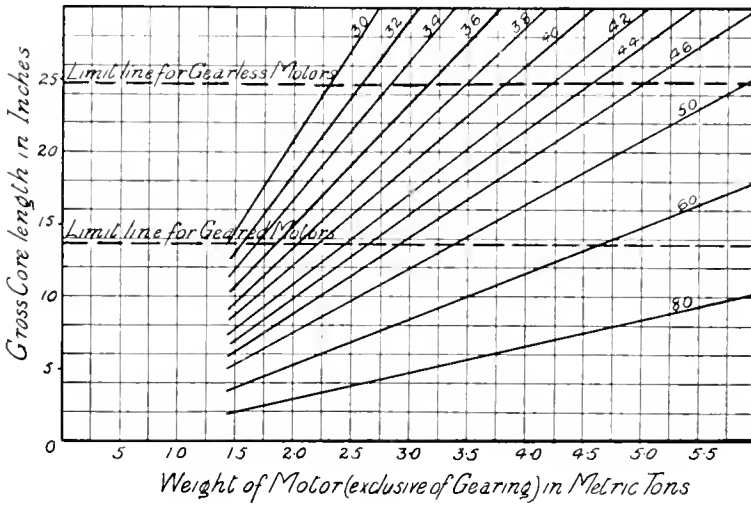

Fig. 354. CURVES SHOWING VALUES OF GROSS CORE LENGTH OF ARMATURE FOR VARIOUS WEIGHTS OF MOTORS AND DIAMETERS OF DRIVING WHEELS. (See Table CXI.)

the value of λg , the gross core length. The gross core length is shown in centimetres in Table CXI., and in the curves of Fig. 354, it is plotted in inches.

TABLE CXI.

Gross Length of Core in Centimetres (λg) of Motors of various Weights, for Driving Wheels of various Diameters, taking $D = 0.5 \times$ Diameter of Driving Wheel.

Total Weight of Motor in Metric Tons.	Diam.	Diameter of Driving Wheel in Inches.														
		30.	32.	34.	36.	38.	40.	42.	44.	46.	48.	50.	55.	60.	70.	80.
1.44	50,000	34.5	30.3	26.9	24	21.5	19.4	17.6	16.0	14.6	13.5	12.4	10.2	8.61	6.32	4.85
1.56	50,600	34.9	30.7	27.2	24.2	21.7	19.6	17.8	16.2	14.8	13.6	12.6	10.3	8.7	6.40	4.91
1.71	60,300	<u>41.6</u>	<u>36.6</u>	<u>32.5</u>	<u>28.9</u>	<u>25.9</u>	<u>23.4</u>	<u>21.2</u>	<u>19.3</u>	<u>17.7</u>	<u>16.3</u>	<u>14.9</u>	<u>12.3</u>	<u>10.4</u>	<u>7.63</u>	<u>5.85</u>
2.2	85,500	58.6	51.5	45.7	40.7	36.5	33.0	29.9	27.2	24.9	22.9	21.1	17.4	14.6	10.7	8.25
2.3	90,300	62.3	54.7	48.6	43.3	<u>38.8</u>	<u>35.0</u>	31.8	28.9	26.4	24.3	22.4	18.4	15.5	11.4	8.75
2.5	100,000		60.6	53.8	48.0	43.0	<u>38.7</u>	<u>35.2</u>	<u>32.0</u>	29.3	26.9	24.8	20.4	17.2	12.6	9.7
3.1	122,500			58.7	52.6	47.5	43.1	<u>39.2</u>	<u>35.8</u>	33.0	30.4	25.0	21.1	15.5	11.9	
3.3	135,000				58.0	52.3	47.5	43.2	<u>39.5</u>	<u>36.4</u>	33.4	27.6	23.2	17.1	13.1	
3.6	145,000				63.4	56.1	51.0	46.5	42.5	<u>39.1</u>	<u>36.0</u>	29.6	24.9	18.4	14.1	
3.8	157,000					60.8	55.3	50.3	46.0	42.3	<u>38.9</u>	<u>32.1</u>	27.0	19.9	15.2	
5.6	235,000									63.3	58.2	<u>43.0</u>	<u>40.5</u>	29.7	22.8	

Values below the heavy black lines refer to gearless motors only.

ELECTRIC RAILWAY ENGINEERING

As a very rough guide, but as one which will enable us to arrive at certain approximate conceptions, let us take the length of the motor over its frame as equal, for gearless motors, to twice the gross core length, and as equal to three times the gross core length for geared motors, as the latter require independent bearings. These figures have been chosen after examining the dimensions of a number of traction motors. For gearless motors the ratio is generally near 2, and for geared motors it varies from 3 to 4.5. The larger figures are, however, for standard motors of several years ago, the most modern designs making the length over frame more nearly 3 for geared motors. Hence we have chosen the latter figure as a basis for comparison. The length over frame does not include the gearing, which latter generally occupies some 5 to 8 ins. axially.

Confining our attention to the standard gauge of 4 ft. 8½ ins., it will not be practicable to allow more than 50 ins. of overall width of motor frame for gearless motors, or more than, say, 43 ins. for geared motors. In the latter case, the remaining space is occupied by the speed reduction gearing. The maximum gross core length of a gearless motor which can be got in, is thus $\frac{50}{2} = 25$ ins., and for geared motors $\frac{43}{3} = 14$ ins. The heavy line in Table CXI. indicates the limit for geared motors, all core lengths above this line being less than 14 ins., and no core length is included which is greater than 25 ins., the limit for gearless motors. The precise value of all such limitations is a matter of detail designing, whereas our present object is to arrive at a broad view of the general nature of the limitations.

We are now able to construct Table CXII. and Fig. 355, which show us for any given weight of gearless motor the minimum practicable diameter of driving wheel, and, in a similar way, Table CXIII. and Fig. 356 for geared motors.

TABLE CXII.

Overall Length of Frame, in Inches, of Gearless Motors of various Weights for Driving Wheels of various Diameters.

Total Weight of Motor in Metric Tons.	Diameter of Driving Wheel in Inches.															
	DEAL.															
	30.	32.	34.	36.	38.	40.	42.	44.	46.	48.	50.	55.	60.	70.	80.	
1.44	50,000	27.2	23.9	21.2	18.9	16.9	15.3	13.7	12.6	11.5	10.6	9.76	8.03	6.78	4.98	3.82
1.56	50,600	27.5	24.2	21.4	19.1	17.1	15.4	14.0	12.7	11.6	10.7	9.83	8.11	6.85	5.04	3.87
1.71	60,300	32.8	28.8	25.6	23.7	20.4	18.4	16.7	15.2	13.9	12.8	11.7	9.70	8.20	6.01	4.60
2.2	85,500	46.1	40.5	36.0	32.1	28.7	26.0	23.5	21.4	19.6	18.0	16.6	13.8	11.5	8.42	6.50
2.3	90,300	49.0	43.1	38.3	35.7	30.6	27.5	25.0	22.7	20.8	19.1	17.6	14.5	12.2	8.97	6.90
2.5	100,000		47.7	42.4	37.8	33.9	30.5	27.7	25.2	23.1	21.2	19.5	16.1	13.5	9.9	7.64
3.1	122,500			46.2	41.4	37.4	34.0	30.8	28.2	26.0	23.9	19.7	16.6	12.2	9.36	
3.3	135,000				45.6	41.2	37.4	34.0	31.1	28.6	26.3	21.7	18.3	13.5	10.3	
3.6	145,000				49.8	44.1	40.1	36.6	33.4	30.8	28.3	23.3	19.6	14.5	11.1	
3.8	157,000					47.9	43.6	39.6	36.2	33.3	30.6	25.3	21.3	15.7	12.0	
5.6	235,000								49.8	45.8	33.9	31.9	23.4	18.0		

Overall Length of Frame in Inches.

LOCOMOTIVES AND MOTOR CARRIAGES

TABLE CXIII.

Overall Length of Frame, in Inches, of Geared Motors of various Weights for Driving Wheels of various Diameters.

Total Weight of Motor in Metric Tons.	D.Wt.	Diameter of Driving Wheel in Inches.														
		30.	32.	34.	36.	38.	40.	42.	44.	46.	48.	50.	55.	60.	70.	80.
1.41	50,000	40.7	35.8	31.8	28.3	25.4	22.9	20.8	18.9	17.3	15.7	14.6	12.1	10.2	7.47	5.73
1.56	50,600	41.2	36.2	32.2	28.6	25.6	23.1	21.0	19.1	17.5	16.1	14.9	12.2	10.3	7.56	5.8
1.71	60,300		43.2	38.4	33.0	30.6	27.6	25.1	22.8	20.9	19.3	17.6	14.5	12.3	9.02	6.91
2.2	85,000					43.1	39.0	35.3	32.1	29.4	27.1	24.9	20.6	17.2	12.6	9.75
2.3	90,300						41.3	37.6	34.2	31.2	28.7	26.5	21.7	18.3	13.5	10.3
2.5	100,000							41.6	37.8	34.6	31.8	29.3	24.1	20.3	14.9	11.4
3.1	122,500									42.3	39.0	35.9	29.5	24.9	18.3	14.1
3.3	135,000										43.0	39.5	32.6	27.4	22.0	15.5
3.6	145,000											42.5	35.0	29.4	21.7	16.7
3.8	157,000												38.0	32.0	23.5	18.0
5.6	255,000														35.1	26.9

Overall Length of Frame in Inches.

As already suggested, these results are controlled by our fundamental assumptions, which can only be general. Cases will be found where greater weights of motor are

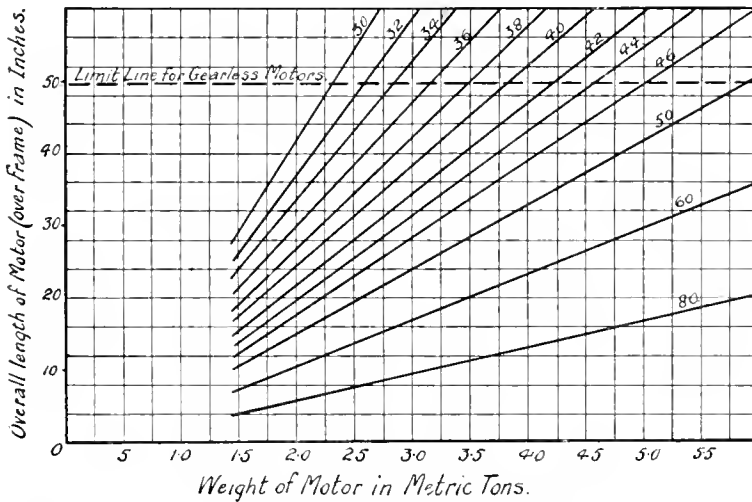

Fig. 355. CURVES FOR GEARLESS MOTORS, SHOWING OVERALL LENGTH OF MOTOR FRAME FOR VARIOUS MOTOR WEIGHTS AND DIAMETERS OF DRIVING WHEELS. (See Table CXIII.)

associated with given driving wheel diameters; nevertheless it is instructive to examine the tendencies at work. The limitations here arrived at are of a general order, which will lead to a sound design without undue crowding of parts, and without resorting to unusual designs as regards form of motors or their location.

The diagrams in Fig. 357 have been constructed from the diagrams in Figs. 355 and 356, and show us, for motors of 75, 150, and 300 h.-p. respectively, the relation between the limiting lowest armature speed at rated output and the driving wheel

ELECTRIC RAILWAY ENGINEERING

diameters. The limiting lowest speed is determined by reference to Fig. 352, which gives a connection between the weight and speed of the motor. From Figs. 355 and 356 we can ascertain what is the weight of the heaviest motor that can be used with a given driving wheel, and then, referring to the curves of Fig. 352, we obtain the motor speed corresponding to this weight. In this way we have plotted the limiting lowest speed practicable, against the diameter of driving wheel for 75, 150, and 300 h.-p. gearless motors in the upper horizontal set of curves in Fig. 357. For geared motors we assume that the gearing occupies 7 ins., or 15 per cent. of the length between wheels, the maximum available length for the motor frame being thus 43 ins.

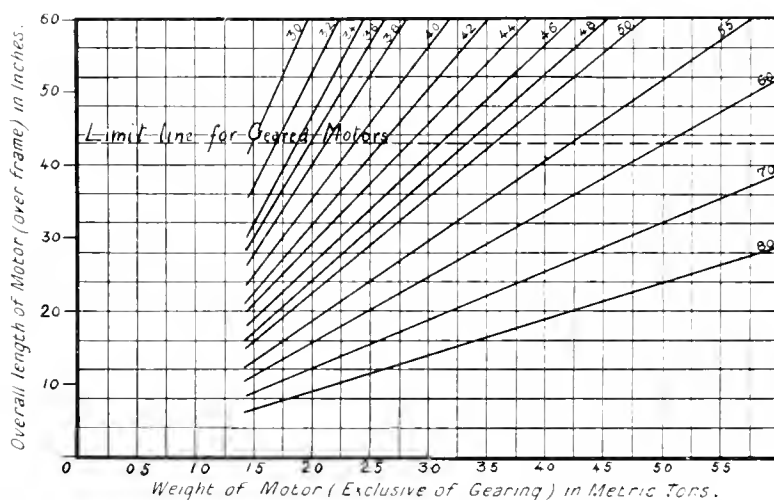

Fig. 356 CURVES FOR GEARED MOTORS, SHOWING OVERALL LENGTH OF MOTOR FRAME FOR VARIOUS MOTOR WEIGHTS AND DIAMETERS OF DRIVING WHEELS. (See Table CXIII.)

Hence we have set this as the limiting motor frame length in Fig. 356, and have derived in a similar way to that just described for gearless motors, the lower horizontal set of curves in Fig. 357, showing the lowest speeds practicable with various driving wheel diameters for motors of 75, 150, and 300 h.-p.

The limiting highest speed is partly a question of commutation and partly a question of mechanical design, in which a leading consideration is the design of the reduction gearing. The ordinary series-wound railway motor, when running at light loads, attains a speed of the order of twice its speed at its rated output. It would therefore appear reasonable to assign the following values as the highest limiting speeds at *rated* loads :—

75 h.-p.	800 r.p.m.
150 h.-p.	600 ..
300 h.-p.	400 ..

We have now the highest limiting speed, and the lowest limiting speed as a function of the driving wheel diameter, for motors of 75, 100, and 300 h.-p. In Tables CXIV., CXV., and CXVI., we have set out the practicable motor speed in revolutions per minute necessary to give running speeds ranging upwards, from 15 miles per hour with driving wheels of diameters from 30 ins. upwards, these three tables relating respectively to 75, 150 and 300 h.-p. motors.

LOCOMOTIVES AND MOTOR CARRIAGES

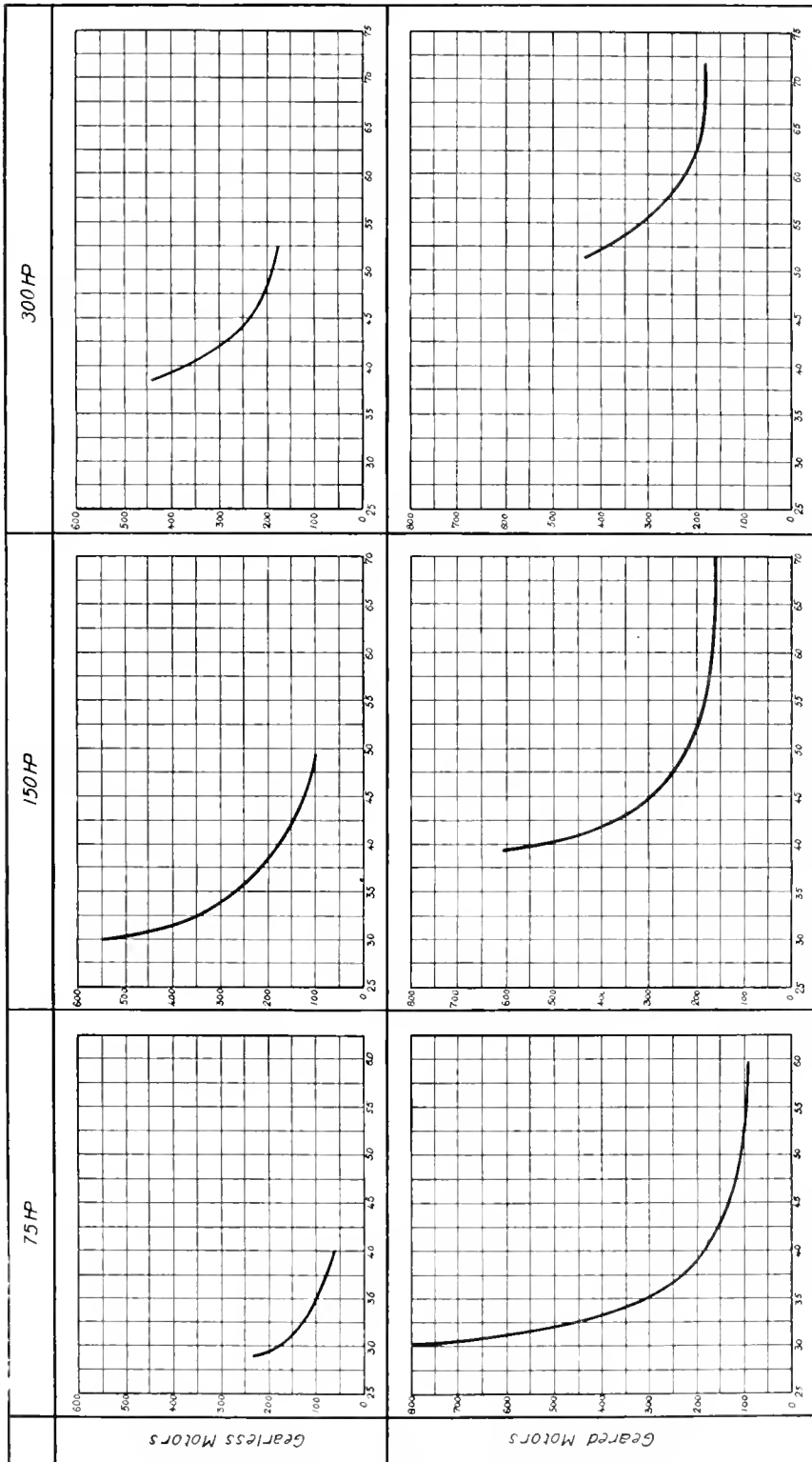

Abcissae denote Diameter of Driving Wheels in Inches

Fig. 357. CURVES SHOWING LIMITING LOWEST SPEEDS OF 75 H.P., 150 H.P. AND 300 H.P. GEARED AND GEARLESS MOTORS FOR VARIOUS DIAMETERS OF DRIVING WHEELS.

Ordinates denote Rated Speed of Motors in Revolutions per Minute

TABLE CXV.
Speeds of 150-h.p. Motor for various Locomotive Speeds in Miles per Hour and various Driving Wheel Diameters.

Diameter of Driving Wheel in Inches.	Ratio of Gearing.															Motor Speeds in Revolutions per Minute.																																																																																																																																																																																																																																																																																																																																																																																																																																																																																																																																																																																																																																																																																																																																																																																																																																																																																																																																																																																																																																																										
	1 : 1.					1 : 2.					1 : 3.						1 : 4.					1 : 5.																																																																																																																																																																																																																																																																																																																																																																																																																																																																																																																																																																																																																																																																																																																																																																																																																																																																																																																																																																																																																																																				
	Speed in Miles per Hour.					Speed in Miles per Hour.					Speed in Miles per Hour.						Speed in Miles per Hour.					Speed in Miles per Hour.																																																																																																																																																																																																																																																																																																																																																																																																																																																																																																																																																																																																																																																																																																																																																																																																																																																																																																																																																																																																																																																				
30	20	30	40	50	60	80	100	15	20	30	40	50	60	80	15	20	30	40	50	60	15	20	30	40	15	20	30	40	600																																																																																																																																																																																																																																																																																																																																																																																																																																																																																																																																																																																																																																																																																																																																																																																																																																																																																																																																																																																																																																													
32	158	316	420	526	636	848	320	366	458	570	696	864	1080	345	459	578	717	878	1080	1350	360	480	600	750	900	1125	1400	1725	2100	2520	3000	3600	4200	4800	5400	6000																																																																																																																																																																																																																																																																																																																																																																																																																																																																																																																																																																																																																																																																																																																																																																																																																																																																																																																																																																																																																																						
34	148	296	396	494	592	792	219	292	382	471	560	648	736	824	330	438	574	710	846	982	315	420	536	652	768	884	1000	1116	1232	1348	1464	1580	1696	1812	1928	2044	2160	2276	2392	2508	2624	2740	2856	2972	3088	3204	3320	3436	3552	3668	3784	3900	4016	4132	4248	4364	4480	4596	4712	4828	4944	5060	5176	5292	5408	5524	5640	5756	5872	5988	6104	6220	6336	6452	6568	6684	6800	6916	7032	7148	7264	7380	7496	7612	7728	7844	7960	8076	8192	8308	8424	8540	8656	8772	8888	9004	9120	9236	9352	9468	9584	9700	9816	9932	10048	10164	10280	10396	10512	10628	10744	10860	10976	11092	11208	11324	11440	11556	11672	11788	11904	12020	12136	12252	12368	12484	12600	12716	12832	12948	13064	13180	13296	13412	13528	13644	13760	13876	13992	14108	14224	14340	14456	14572	14688	14804	14920	15036	15152	15268	15384	15500	15616	15732	15848	15964	16080	16196	16312	16428	16544	16660	16776	16892	17008	17124	17240	17356	17472	17588	17704	17820	17936	18052	18168	18284	18400	18516	18632	18748	18864	18980	19096	19212	19328	19444	19560	19676	19792	19908	20024	20140	20256	20372	20488	20604	20720	20836	20952	21068	21184	21300	21416	21532	21648	21764	21880	21996	22112	22228	22344	22460	22576	22692	22808	22924	23040	23156	23272	23388	23504	23620	23736	23852	23968	24084	24200	24316	24432	24548	24664	24780	24896	25012	25128	25244	25360	25476	25592	25708	25824	25940	26056	26172	26288	26404	26520	26636	26752	26868	26984	27100	27216	27332	27448	27564	27680	27796	27912	28028	28144	28260	28376	28492	28608	28724	28840	28956	29072	29188	29304	29420	29536	29652	29768	29884	30000	30116	30232	30348	30464	30580	30696	30812	30928	31044	31160	31276	31392	31508	31624	31740	31856	31972	32088	32204	32320	32436	32552	32668	32784	32900	33016	33132	33248	33364	33480	33596	33712	33828	33944	34060	34176	34292	34408	34524	34640	34756	34872	34988	35104	35220	35336	35452	35568	35684	35800	35916	36032	36148	36264	36380	36496	36612	36728	36844	36960	37076	37192	37308	37424	37540	37656	37772	37888	38004	38120	38236	38352	38468	38584	38700	38816	38932	39048	39164	39280	39396	39512	39628	39744	39860	39976	40092	40208	40324	40440	40556	40672	40788	40904	41020	41136	41252	41368	41484	41600	41716	41832	41948	42064	42180	42296	42412	42528	42644	42760	42876	42992	43108	43224	43340	43456	43572	43688	43804	43920	44036	44152	44268	44384	44500	44616	44732	44848	44964	45080	45196	45312	45428	45544	45660	45776	45892	46008	46124	46240	46356	46472	46588	46704	46820	46936	47052	47168	47284	47400	47516	47632	47748	47864	47980	48096	48212	48328	48444	48560	48676	48792	48908	49024	49140	49256	49372	49488	49604	49720	49836	49952	50068	50184	50300	50416	50532	50648	50764	50880	50996	51112	51228	51344	51460	51576	51692	51808	51924	52040	52156	52272	52388	52504	52620	52736	52852	52968	53084	53200	53316	53432	53548	53664	53780	53896	54012	54128	54244	54360	54476	54592	54708	54824	54940	55056	55172	55288	55404	55520	55636	55752	55868	55984	56100	56216	56332	56448	56564	56680	56796	56912	57028	57144	57260	57376	57492	57608	57724	57840	57956	58072	58188	58304	58420	58536	58652	58768	58884	59000	59116	59232	59348	59464	59580	59696	59812	59928	60044	60160	60276	60392	60508	60624	60740	60856	60972	61088	61204	61320	61436	61552	61668	61784	61900	62016	62132	62248	62364	62480	62596	62712	62828	62944	63060	63176	63292	63408	63524	63640	63756	63872	63988	64104	64220	64336	64452	64568	64684	64800	64916	65032	65148	65264	65380	65496	65612	65728	65844	65960	66076	66192	66308	66424	66540	66656	66772	66888	67004	67120	67236	67352	67468	67584	67700	67816	67932	68048	68164	68280	68396	68512	68628	68744	68860	68976	69092	69208	69324	69440	69556	69672	69788	69904	70020	70136	70252	70368	70484	70600	70716	70832	70948	71064	71180	71296	71412	71528	71644	71760	71876	71992	72108	72224	72340	72456	72572	72688	72804	72920	73036	73152	73268	73384	73500	73616	73732	73848	73964	74080	74196	74312	74428	74544	74660	74776	74892	75008	75124	75240	75356	75472	75588	75704	75820	75936	76052	76168	76284	76400	76516	76632	76748	76864	76980	77096	77212	77328	77444	77560	77676	77792	77908	78024	78140	78256	78372	78488	78604	78720	78836	78952	79068	79184	79300	79416	79532	79648	79764	79880	80000	80116	80232	80348	80464	80580	80696	80812	80928	81044	81160	81276	81392	81508	81624	81740	81856	81972	82088	82204	82320	82436	82552	82668	82784	82900	83016	83132	83248	83364	83480	83596	83712	83828	83944	84060	84176	84292	84408	84524	84640	84756	84872	84988	85104	85220	85336	85452	85568	85684	85800	85916	86032	86148	86264	86380	86496	86612	86728	86844	86960	87076	87192	87308	87424	87540	87656	87772	87888	88004	88120	88236	88352	88468	88584	88700	88816	88932	89048	89164	89280	89396	89512	89628	89744	89860	89976	90092	90208	90324	90440	90556	90672	90788	90904	91020	91136	91252	91368	91484	91600	91716	91832	91948	92064	92180	92296	92412	92528	92644	92760	92876	92992	93108	93224	93340	93456	93572	93688	93804	93920	94036	94152	94268	94384	94500	94616	94732	94848	94964	95080	95196	95312	95428	95544	95660	95776	95892	96008	96124	96240	96356	96472	96588	96704	96820	96936	97052	97168	97284	97400	97516	97632	97748	97864	97980	98096	98212	98328	98444	98560	98676	98792	98908	99024	99140	99256	99372	99488	99604	99720	99836	99952	100068	100184	100300	100416	100532	100648	100764	100880	101000	101116	101232	101348	101464	101580	101696	101812	101928	102044	102160	102276	102392	102508	102624	102740	102856	102972	103088	103204	103320	103436	103552	103668	103784	103900	104016	104132	104248	104364	104480	104596	104712	104828	104944	105060	105176	105292	105408	105524	105640	105756	105872	105988	106104	106220	106336	106452	106568	106684	106800	106916	107032	107148	107264	107380	107496	107612	107728	107844	107960	108076	108192	108308	108424	108540	108656	108772	108888	109004	109120	109236	109352	109468	109584	109700	109816	109932	110048	110164	110280	110396	110512	110628	110744	110860	110976	111092	111208	111324	111440	111556	111672	111788	111904	112020	112136	112252	112368	112484	112600	112716	112832	112948	113064	113180	113296	113412	113528	113644	113760	113876	113992	114108	114224	114340	114456	114572	114688	114804	114920	115036	115152	115268	115384	115500	115616	115732	115848	115964	116080	116196	116312	116428	116544	116660	116776	116892	117008	117124	117240	117356	117472	117588	117704	117820

ELECTRIC RAILWAY ENGINEERING

TABLE CXVI.

Speeds of 300-h.-p. Motor for various Locomotive Speeds in Miles per Hour and various Driving Wheel Diameters.

Diameter of Driving Wheel in Inches.	Ratio of Gearing.															Motor Speed in Revolutions per Minute.		
	1 : 1.					1 : 2.					1 : 3.			1 : 4.			1 : 5.	
	Speed in Miles per Hour.					Speed in Miles per Hour.					Speed in Miles per Hour.			Speed in Miles per Hour.			Speed in Miles per Hour.	
	30.	40.	50.	60.	80.	15.	20.	30.	40.	15.	20.	30.	15.	20.	15.		20.	
30																		
32																		
34																		
36																		
38																		
40																		
42		320	400															
44		305	382															
46		292	365															
48	210	280	350															
50	202	268	336	402						402								
55	183	244	305	366				366		366		368						
60	168	224	280	336			224	336		252	336		336					
70	144	192	240	288	383		192	288	384	216	288		288	384	360			
80	126	168	210	252	336		168	252	336	189	252	378	252	336	315			

No speeds are included in these tables which fall below the lowest limiting speeds of Fig. 357, or above the highest limiting speeds given above. The results in Tables CXIV., CXV., and CXVI. have been plotted in Fig. 358, which gives a series of enclosed areas obtained by plotting the maximum and minimum practicable speeds of motor for each speed of train in miles per hour (corresponding to the various driving wheel diameters). These areas indicate the limits of motor speed and train speed for motors of 75, 150, and 300 rated h.-p. for various gear ratios. Thus, supposing the locomotive speed and its rated horse-power are given, we can determine the most desirable motor speed and driving wheel diameter. It is now probable that the best point at which to work will be somewhere in the region of the centre of gravity of each of the areas in Fig. 358. Hence we have determined roughly the centre of each area, and in Table CXVII. we have brought together the particulars of the motors corresponding to each of these points.

Table CXVII. shows the speed in miles per hour, the revolutions per minute of the motor, diameter of driving wheel, and weight per horse-power of output. The weight of motor and gearing has been included on the assumption that the gearing weighs an additional 15 per cent. of the motor weight. Taking the weight of the auxiliary equipment at 0.005 ton per horse-power, the total weight of motor, gearing, and equipment per horse-power, has been added. The figure of 0.005 ton per horse-power is based on the figures for four representative locomotives, particulars of which are given in Table CXVIII. The weight of the auxiliary equipment per horse-power comes out to a very uniform value in these cases, the average being 0.005 ton per horse-power.

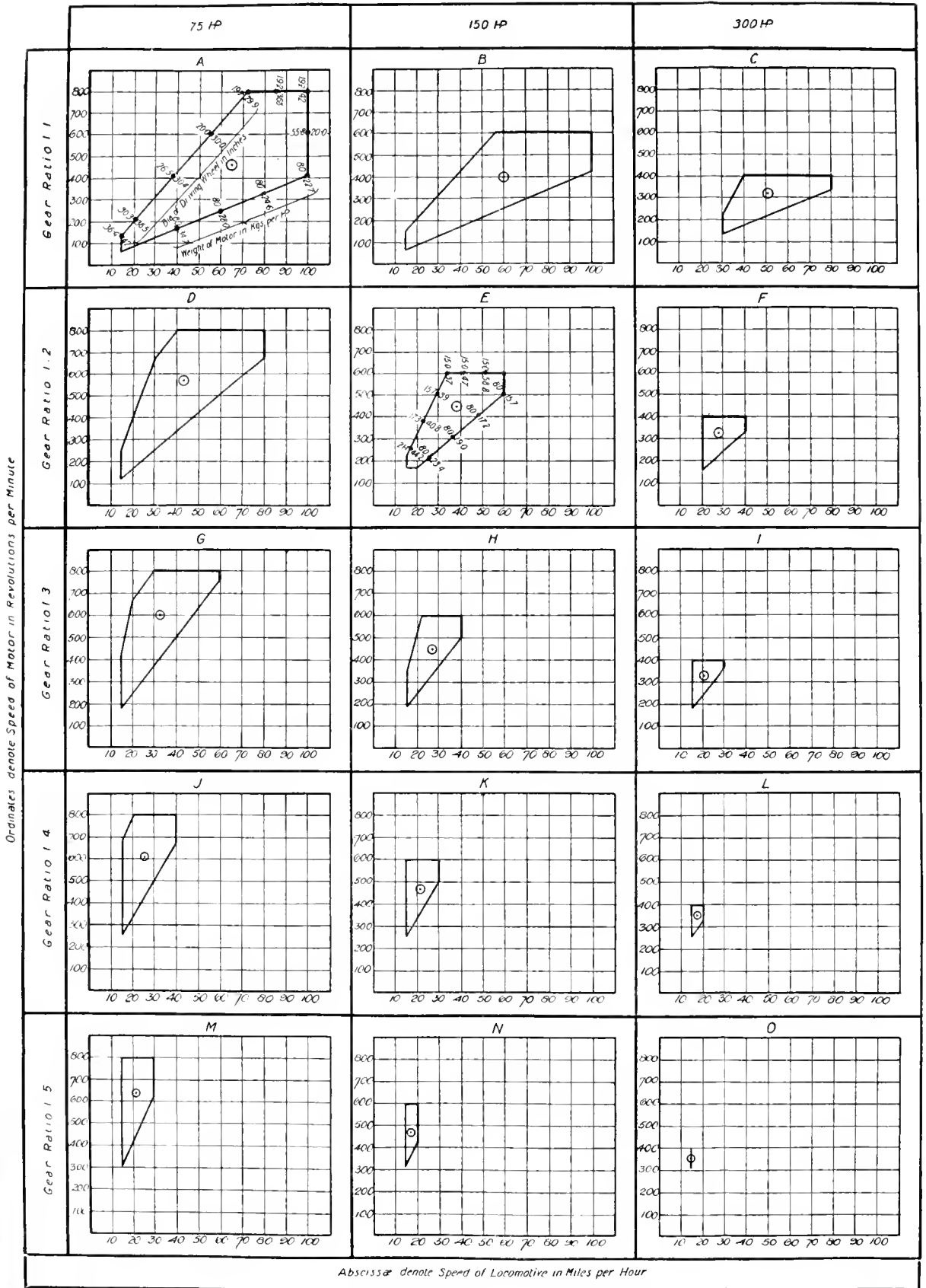

Abscissæ denote Speed of Locomotive in Miles per Hour

Fig. 358. LIMITING VALUES OF MOTOR SPEED (R.P.M.) FOR DIFFERENT TRAIN SPEEDS (MILES PER HOUR) FOR MOTORS OF 75, 150, AND 300 H.P.

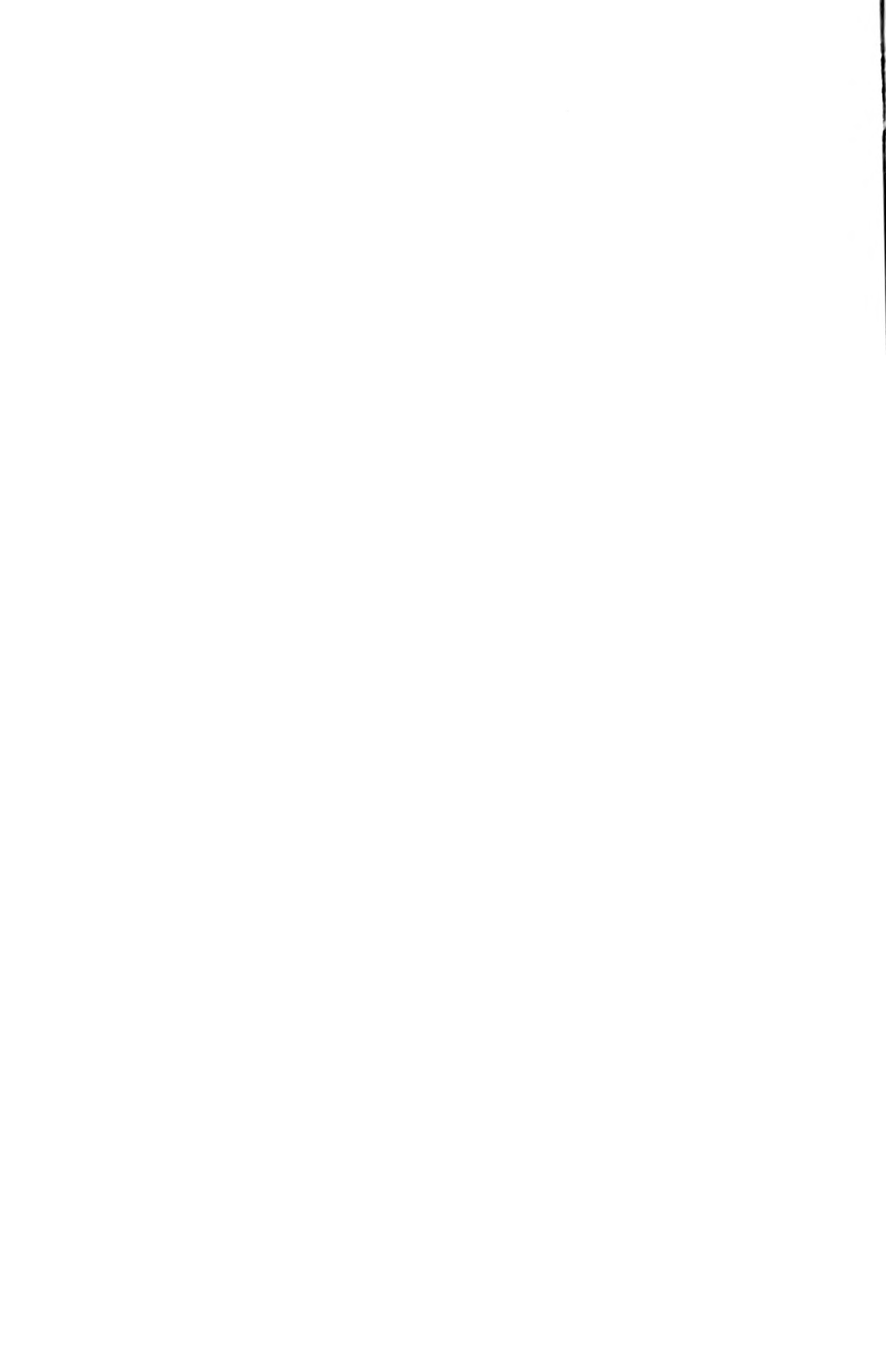

LOCOMOTIVES AND MOTOR CARRIAGES

TABLE CXVII.
Showing Particulars of Motors for the Mean Points in Fig. 358.

Ratio of Gearing.		75 H.-p.						150 H.-p.						300 H.-p.						
		Speed in Miles per Hour.	Motor Speed in Revolutions per Minute.	Diameter of Driving Wheel in Inches.	Motor only.	Motor + Gearing.	Motor + Gearing + Equipment.	Ratio of Gearing.	Speed in Miles per Hour.	Motor Speed in Revolutions per Minute.	Diameter of Driving Wheel in Inches.	Motor only.	Motor + Gearing.	Motor + Gearing + Equipment.	Ratio of Gearing.	Speed in Miles per Hour.	Motor Speed in Revolutions per Minute.	Diameter of Driving Wheel in Inches.	Motor only.	Motor + Gearing.
1.1	1.1	65	450	48.6	0.0220	0.0270	1.1	60	400	50.4	0.0173	0.0173	0.0223	1.1	50	310	51.4	0.0140	0.0140	0.0190
1.2	1.2	43	650	51.6	0.0200	0.0250	1.2	37	450	50.4	0.0157	0.0181	0.0231	1.2	27	320	56.6	0.0135	0.0135	0.0205
1.3	1.3	33	600	53.5	0.0200	0.0280	1.3	27	450	60.6	0.0157	0.0181	0.0231	1.3	26	330	61.4	0.0135	0.0135	0.0205
1.4	1.4	25	600	56.0	0.0200	0.0280	1.4	21	460	61.5	0.0156	0.0179	0.0229	1.4	18	350	63.1	0.0131	0.0131	0.0201
1.5	1.5	22	650	57.0	0.0198	0.0277	1.5	18	480	63.0	0.0155	0.0178	0.0228	1.5	15	357	70.6	0.0129	0.0148	0.0198

ELECTRIC RAILWAY ENGINEERING

TABLE CXVIII.

Data for Weights of Locomotives and Motor Equipments.

Railway on which Locomotive is used.	Total H.-P. of Motors.	Weight in Metric Tons.				Weight in Metric Tons per H.-P.			
		Complete Locomotive.	Electrical Equipment, including Motors.	Motors only.	Electrical Equipment only.	Complete Locomotive.	Electrical Equipment, including Motors.	Motors only.	Electrical Equipment only.
Baltimore and Ohio, Geared	800	73	20.3	16.1	4.2	0.091	0.0255	0.0201	0.00526
Paris-Orleans, Geared	1,000	49	21.3	16.2	5.0	0.049	0.0213	0.0162	0.00500
New York Central, Gearless	2,200	85	27.8	17.1	10.6	0.0386	0.0125	0.0077	0.00477
Central London Railway, Gearless	680	41.3	24.8	21.8	3.0	0.0645	0.0321	0.0320	0.00435

The results in Table CXVII. have been plotted in Fig. 359. The curves in the left-hand column of this figure show the variation of weight of motor gearing and equipment, with the speed in miles per hour, for motors of 75, 150, and 300 h.-p. In the right-hand column of the same figure the curves show for any given speed in miles per hour the motor speed (revolutions per minute), the driving wheel diameter, and the gear ratio.

The weight of the rheostats and control apparatus in general, is, of course, a function of the frequency and duration of rheostatic running. Hence for very severe service 0.005 tons per horse-power will not cover the weight of equipment other than motor weight, and this figure may approach 0.008 or even 0.010 tons per horse-power. Of course, however, it will be independent of the ratio of gearing and the diameter of the driving wheels.

A high voltage traction system is necessary before thoroughly rapid progress can be made in superseding steam by electricity on main line railways. Some progress has already been made along these lines, both with single-phase and polyphase systems. An as yet much-neglected system is that employing high voltage continuous-current motors. Some years ago¹ one of the present writers put in a word for this system, and in a fairly careful comparison for a certain case, arrived at results which were much more satisfactory than those obtained by single-phase operation. But little interest could then be roused on the subject. Now, however, it is again attracting attention, and, in one form or another, will doubtless be actively followed up. High tension continuous-current railway motors are already on the market, and it is the writers' belief that half the sum spent in developing the single-phase commutator motor to its present condition (in which it still remains less efficient, more bulky, and less satisfactory in several respects than the 600-volt continuous-current motor) will result in the development of thoroughly satisfactory high tension continuous-current motors. These motors will be as efficient and as light for a given temperature rating and a given speed, as the present standard 600-volt motors. The commutation will be better. As traction motors increased in size, they were designed

¹ "The Continuous-current System and the Single-phase System for Traction." H. M. Hobart. *Electrical Review*, London, Vol. LIV., p. 693, April 29th, and May 6th, 1904.

LOCOMOTIVES AND MOTOR CARRIAGES

successively with five, four, three, two, and finally one turn per segment. Beyond that point, the commutation difficulties with increasing capacity can only be met with reversing poles, or their equivalent. Going up to 1,500 volts and higher, it will again be practicable in motors of large capacity to improve the commutation in virtue of the

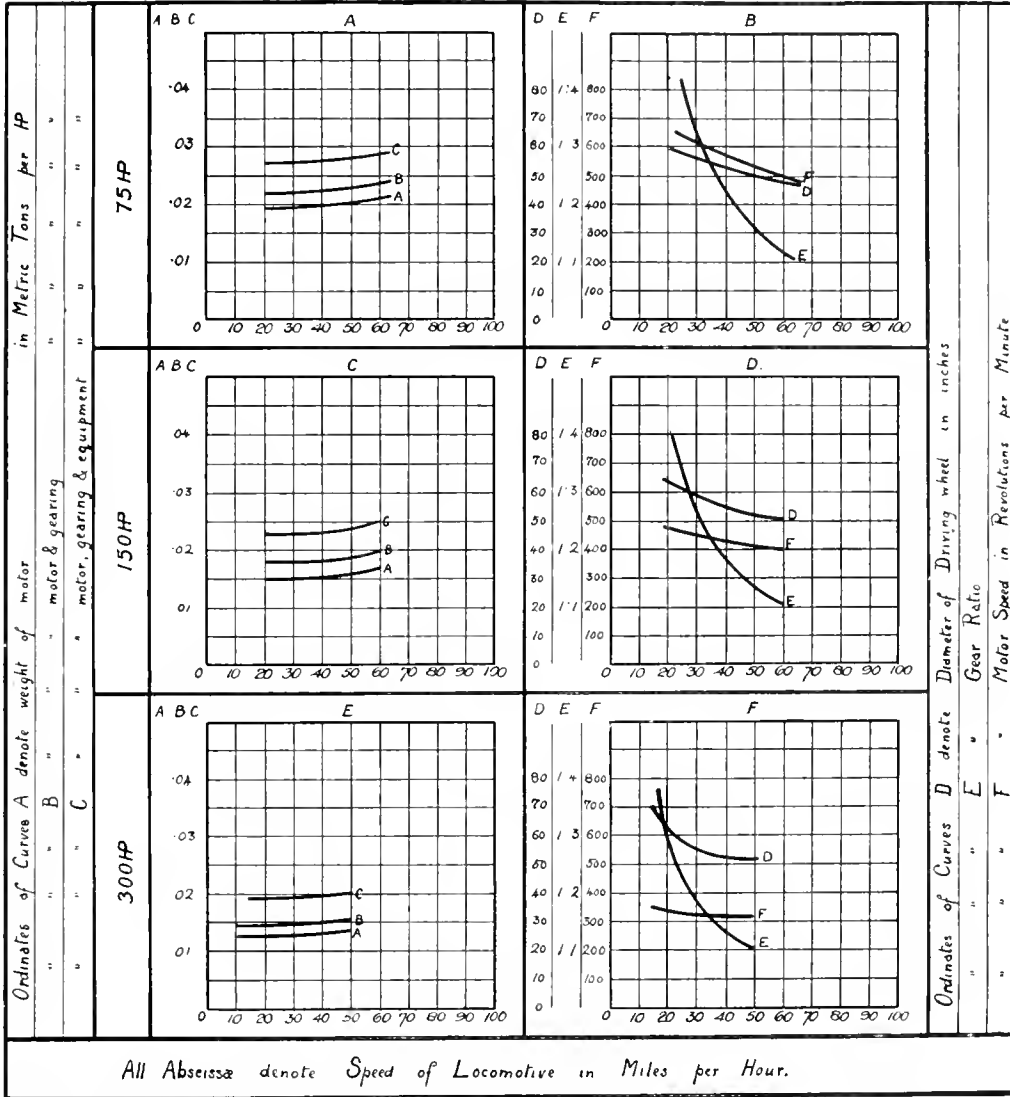

Fig. 359. CURVES SHOWING RELATION BETWEEN SPEED OF LOCOMOTIVE AND DRIVING WHEEL DIAMETER, MOTOR SPEED, AND WEIGHT.

decreased current, and when, in addition to this, reversing poles are employed (in the cases where they are suitable), there need be no apprehension that commutation will present any difficulties. Indeed, the commutator of a 1,500-volt continuous-current motor will be much shorter than that of a 600-volt continuous-current motor, since the current to be collected is so much less. The total brush surface will be correspondingly

ELECTRIC RAILWAY ENGINEERING

reduced. Thus a greater space between wheels may be devoted to armature and winding, and motors of larger capacity will be practicable for a given driving wheel diameter and gear ratio. In other words, the limiting areas in Fig. 358 will become larger. The very slightly increased space necessary for high voltage slot insulation, will be an almost negligible factor as affecting the bulk of the motor for a given rated capacity when this rated capacity is a matter of 100 h.-p. and upwards.¹

If, on the other hand, we turn our attention to the single-phase commutator motor, we find it in possession of over twice as large a commutator (as this is for 250 volts) as its 600-volt continuous-current equivalent. This alone takes away valuable space between wheels, and leaves a less available width for the armature. As, however, the latter also is large for its rated output (for equal rated speeds), the areas corresponding to those in Fig. 358, are, for single-phase commutator motors, very restricted indeed. There will be a tendency to keep down the dimensions by employing a higher rated speed and ratio of gearing. This means, in motors of high rated capacity, serious losses in gearing and rapid deterioration of gearing. It is also unfavourable for commutator and brushes.

There thus appears good reason to anticipate better results from high voltage continuous-current traction than from single-phase traction with commutator motors. For long distance service, however, both may in the course of development be surpassed by the polyphase induction motor, which, when examined on the plan of the diagrams of Fig. 358, shows up very favourably in this class of service. For locomotive service, sight must not be lost of the alternative single-phase system with a motor-generator on the locomotive, intermediate between the high tension line and the motors. Even in this case, fairly high tension continuous-current motors on the trucks may give the best results because of the more compact commutator and the more satisfactory commutation which will be obtained in large capacity motors, by an increase in the armature voltage.

The lower saturation necessary in an alternating-current motor as compared with a continuous-current motor, the impracticability of employing the outer shell as active material in the magnetic circuit, the larger commutator and greater amount of brush gear, tend to make the single-phase motor very heavy for its dynamical capacity, compared with the continuous-current motor. Moreover, the former is so much lower in efficiency than the latter, and accordingly has to dissipate so much more heat, that the service capacity is low in comparison with the dynamical capacity. Any service, therefore, which makes the heating of the motors a limiting feature, requires a weight of single-phase motor equipment far in excess of that necessary on the continuous current system.

The great disadvantage of the single-phase motor as regards weight, has been very clearly brought out by Carter in his reply to the discussion of his recent paper entitled "Technical Considerations in Electric Railway Engineering" (read before the British Institution of Electrical Engineers, January 25th, 1906). In the discussion on the paper, Dawson made the following statement:—

"The weight of a 150-h.-p. motor, rated on the American principle to which the author referred, is 2·7 tons, and the weight of a 115-h.-p. motor rated exactly on the

¹ For smaller capacities, 1,500-volt continuous-current armatures would, through the increased space required for slot insulation, be slightly larger for a given output and speed. In a general way, the most favourable voltage, from the standpoint of the design of the motor, increases as the rated output increases.

ELECTRIC RAILWAY ENGINEERING

Gearing increases the above motor weights by 10 to 15 per cent. Auxiliary equipment, in the case of the continuous current system, amounts to some 4 to 6 kilogrammes per rated horse-power of the motors. It is highly improbable that for single-phase equipments, the auxiliary equipment weighs less than 10 kilogrammes per (correctly) rated horse-power of the motors.

Schoepf, in the course of the discussion, also quoted some figures which, rightly considered, indicate the great equipment weight incident to the single-phase system. He gave the weight of the single-phase equipment of a motor-coach, suitable for use on the suburban lines of the London, Brighton and South Coast Railway, as 31,000 lbs., and the continuous-current equipment of the motor-coaches used on the Metropolitan Railway as 29,500 lbs. Since on the former system, two motor-coaches are required for a 3-coach train, and on the latter, two motor-coaches for a 6-coach train, the coaches being of practically the same size in the two cases, it follows that the single-phase equipment for a given train is more than twice as heavy as the corresponding continuous-current equipment for this class of service.

The service capacity of the single-phase motor is even lower, for its weight, in comparison with the continuous-current motor, than the hourly rating would indicate. In the hour run the greater part of the heat is expended in raising the temperature of the motor and but little is dissipated, whilst the final temperature attained in service depends on the rate at which the heat can be dissipated by the motor. The heavier the motor the greater will be its capacity for heat and the higher it will rate; but the increased weight does not involve a proportional increase in dissipative power, and accordingly the service capacity is low for the rating. Comparison on the basis of a definite temperature rise after 1 hour's run, therefore, is too favourable to the single-phase motor.

It is thus evident that the single-phase railway motor is greatly handicapped as regards weight. The seriousness of this disadvantage is made the more apparent by reference to the curves in Fig. 358 (facing p. 384). For the single-phase motor the areas in that figure will be much more restricted. On the other hand, with high tension continuous-current motors, or with polyphase induction motors, the areas will increase.

Thus from the standpoint of its technical merits, the single-phase commutator motor is at present a factor in the railway electrification problem only in so far as the possibility of its further improvement at an early date entitles it to consideration. Although the last three years have witnessed the advent of several types of single-phase commutator motor, each of which constitutes a great step in advance of the old induction type single-phase motor without commutator, there is still a wide gap to be bridged before it can, on the basis of its engineering merits, rival the continuous-current motor. The single-phase motor has the non-technical advantage that it is now fully realised that some radical innovation is essential to the success of railway electrification, and it appeals to the speculative instincts in human nature to take up a promising novelty rather than to undertake radical but comparatively uninteresting modifications of a well-tried and reliable system, especially as there is a prevailing belief that this would only postpone the inevitable, ultimately successful, introduction of the alternating current railway motor. It will, however, not be denied that a treble or quadruple increase in the traditional continuous-current trolley voltage would permit of greatly increasing the practicability of introducing electric traction on main line railways without discarding continuous-current railway motors.

LOCOMOTIVES AND MOTOR CARRIAGES

The single-phase commutator motor is not readily understood from an abrupt description of the motor as it now stands developed. It is instructive, and conduces to a better understanding of this motor, to trace the evolution of the ideas which have culminated in its inception. The polyphase induction motor first attracted general attention fifteen years ago, on the occasion of the Frankfort Exhibition. The simplicity of its construction, and especially the absence of a commutator, at once led to very optimistic predictions as to its rapid and ultimately universal adoption for all work for which electric motors are required. The polyphase induction motor was found to have high efficiency and high starting torque. The dependence of a high power factor upon the use of an excessively small air gap, was felt to be a comparatively trifling drawback to set against the otherwise excellent mechanical design. In America the induction motor was built rather large and heavy, with a reasonably deep air gap, and with partly or completely open slots and form-wound coils. In consequence of these concessions to the requirements of a rugged construction, it had a somewhat lower power factor than the European induction motors, which were built with an excessively small air gap, hand-wound coils, and with a minimum of material. A disadvantage of the polyphase induction motor, much more serious than poor power factor and small air gap, soon came to be recognised. This related to the inefficiency with which variable speed could be obtained. The simplest method consisted in the introduction of resistances in the rotor circuits, but this involved great sacrifice in efficiency. The efficiency decreased in direct proportion to the speed, so that at one-quarter or one-half full speed, the efficiency was respectively 25 and 50 per cent. of the full speed efficiency. The first suggestions for employing the polyphase induction motor for traction work, were met with this objection: that variable speed could not be economically obtained. This led to the development of the then so-called "concatenated" system of motor control. This is now designated "cascade" control, and consists in the use of a main motor and an auxiliary motor. For full speed the main motor alone is in circuit; for half-speed the main motor supplies half its energy mechanically direct to the train, and the other half electrically from its secondary to the primary of the auxiliary motor. This system is exploited by the firm of Ganz & Co., of Buda-Pesth, and is in successful operation on the Valtellina Railway in Northern Italy, and on other less important roads. It permits of regenerative braking above half-speed. The chief objections to this system, in addition to the still grave limitations to efficient speed control, are the small air gaps of the motors, their low power factor, the weight and cost of the auxiliary motors, the complicated control connections, and the need for at least two trolley wires or rails, and for a corresponding number of trolleys or contact shoes. This system has the great advantage of employing three-phase motors, which, for a given output, may be built lighter and cheaper than continuous-current motors, and, for high rated speeds, are more efficient. At a sufficiently low periodicity, the power factor is very high, and all the properties are greatly improved. Of course, the main advantage is that inherent to all alternating current systems: the facility of transformation, which permits the use of high voltage transmission lines, and thus of the economic transmission of electric energy over long distances.

On the now historical high speed railway tests at Zossen, near Berlin, we again find three-phase motors employed, but not with concatenated connection. Little significance is, however, to be attached to this latter circumstance, since these tests were made more with a view to establishing the practicability of attaining high speeds,

ELECTRIC RAILWAY ENGINEERING

and of collecting the high voltage electric current at these speeds. Patent considerations probably also affected the choice of system.¹

The speed-torque characteristic of the polyphase induction motor is unfavourable for traction in that its inherent property of running at constant speed independently of the torque, imposes far heavier peaks of load upon the generating station and on the line than are imposed by the continuous-current series motor, in which the speed falls off as the torque increases, thus equalising the load to a considerable extent. This inferiority of the polyphase induction motor becomes greatly accentuated in main line work with heavy trains running at high speeds at great distances apart, and would easily lead to requiring power-house installations capable of supplying twice as high peaks of load as would be required of power-house installations for roads employing motors with the speed-torque characteristic of the continuous-current motor.

The constant speed characteristic of the motors has the further practical disadvantage of confining their use to trains drawn by a single locomotive or motor-coach. In operation the driving wheels are worn down by some 8 per cent. before being retired, and if a train were drawn by two units, one with new wheels and the other with worn wheels, the motors on the former might be running 8 per cent. slower than those on the latter, taking practically all the load, and possibly driving the others as generators.² This prevents the promiscuous mixing of motor stock which is inevitable where a multiple unit system is employed.

The chief faults of the three-phase motor for railway electrification, may be summed up as follows:—

- (1) Constant speed characteristic;
- (2) Necessity for at least two trolleys;
- (3) Small air gap;
- (4) Low average power factor.

From the very earliest days of three-phase motor developments it has been known that, once started, a three-phase motor will continue to run when one of the three circuits leading to it is opened. It thus operates as a single-phase motor. This property is used on three-phase railways at points where the nature of the line does not permit of more than one trolley. It was also known that a three-phase motor would start as a single-phase motor, if, with one of its windings short-circuited, another was thrown on the line. Why then is not the first of the above-tabulated objections, *i.e.*, the need for more than one trolley, thereby overcome? It is not overcome for the reason that this pure induction-type single-phase motor has exceedingly weak starting torque, and far lower capacity than when operated three-phase, a lower average power factor, and greater heating for a given load. Nevertheless, the need for a single-phase motor was believed to be so acute, that every attempt was made to improve the properties of the pure induction type single-phase motor without a commutator. At the end of ten years of effort, nothing in the remotest degree approaching a commercially satisfactory motor had been produced on these lines.

Matters were in this state in the beginning of the year 1901. In this year, Heyland and Latour independently demonstrated the practicability of operating three-phase motors at unity power factor at some one load, by the addition of a commutator

¹ It is notable that Reichel, who was prominently associated with the design of the Siemens and Halske equipments and with the conduct of these Zossen tests, is now an advocate of the employment of the continuous-current motor for railway electrification.

² See Carter, "Elec. Rev." Vol. 54, p. 868. Also "Jour. Inst. Elec. Eng." Vol. 36, p. 256.

LOCOMOTIVES AND MOTOR CARRIAGES

to the rotor, thus reviving arrangements more or less resembling those proposed in 1888 by Wilson (see British Patent No. 18,525 of 1888) and reinvented, tested, and set aside by Görges in 1891. The light thrown by these investigations of Heyland and Latour on the properties of polyphase induction motors and the formulation by Latour of the closely related conception of the panchronous operation of generators, were soon followed by another very important advance, namely, the invention by Winter and Eichberg of an economical means of controlling the speed of three-phase motors. By means of brushes bearing on a commutator, these inventors supplied current to the rotor windings of an ordinary polyphase induction motor, using a variable voltage source, such as a variable ratio transformer or, and generally preferably, an induction regulator. The rotor speed is inversely proportional to the voltage applied at the brushes. This invention would undoubtedly have led to renewed activity in the use of three-phase motors for railway electrification, in spite of the double-trolley difficulty, had not Lamme in Pittsburg, U.S.A., already announced the success of a *single-phase* railway system in which a series-wound, laminated field, commutator motor was employed. At any rate, Latour in Paris and Winter and Eichberg in Vienna and Berlin soon evolved from this variable speed idea a type of single-phase commutator motor which, however great its faults, is a tremendous advance on the induction type of single-phase motor without commutator.

The Repulsion Type of Single-Phase Commutator Motor.

A form of single-phase commutator motor which has been proposed and tried for railway work, is the so-called repulsion motor. This was invented many years ago by Elihu Thomson at Lynn, U.S.A., and has been employed to some extent where small stationary motors, having series characteristics, are required.

It is shown diagrammatically in Fig. 360. It has the advantage of having no conducting connection between the armature and power supply, so that the field may be wound for high potential, although this entails extra weight and expense on account of the space required for the heavier insulation between field turns. Another advantage of the repulsion motor is that it cannot flash over at the commutator, since the brushes are short circuited. For reversing the direction of running and for regenerative braking, either the brushes must be shifted, or more or less complicated control of the stator connections must be employed. This motor has an effective range of speed from low speeds up to about 25 per cent. above synchronous speed, above which the commutation is unsatisfactory.

In 1903 the repulsion motor was taken up for alternating current traction work.

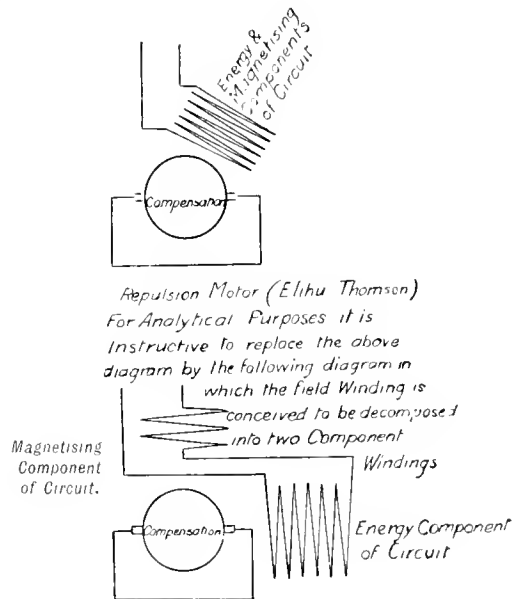

Fig. 360.—DIAGRAM OF REPULSION
TYPE SINGLE-PHASE MOTOR.

ELECTRIC RAILWAY ENGINEERING

The results obtained indicate that it has a fair average power factor, but considerable rotor losses and a somewhat low specific starting torque. It now appears to have been abandoned in favour of the Latour-Winter-Eichberg and the Lamme types of motor.

The L. W. E. Type of Single-Phase Commutator Motor.

The Latour-Winter-Eichberg single-phase motor which is shown diagrammatically in Fig. 361, resembles the repulsion motor in having short-circuited brushes on the commutator under the poles: in having an effective range of speed for practical work from low-speed to a little above synchronism, and in having rather excessive rotor losses. It may in fact, as far as its main action is concerned, be regarded as a repulsion motor in which, instead of the brushes being shifted to change the direction or magnitude of the torque, the exciting field is shifted by the introduction of a cross

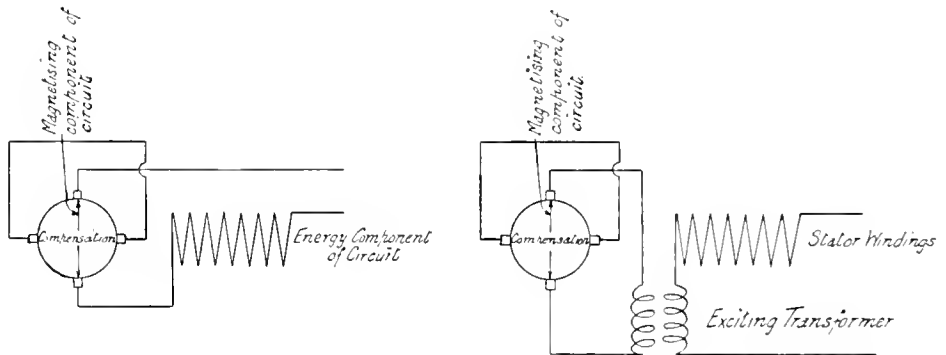

Fig. 361. DIAGRAMS OF THE LATOUR-WINTER-EICHBERG TYPE OF SINGLE-PHASE COMMUTATOR MOTOR.

The diagram at the left shows the arrangement without a transformer.

" " " " right " " " " with " "

In the Latour-Winter-Eichberg type the compensation is obtained by the induced current in the armature between the short-circuited brushes.

field in phase with it. This auxiliary field is produced by introducing into the armature, through brushes at the neutral points, either the main power current, or a current proportional to the same, taken from a series transformer. The two alternative arrangements are shown in Fig. 361. The latter of these has the following advantages over the former: (1) There is no conducting connection between armature and power supply, so that the stator can be wound for high, or any desired pressure. (2) The motor characteristics can be varied by varying the ratio of the auxiliary transformer on the secondary side, which involves dealing only with small currents at low voltage, and affords an exceedingly safe and flexible method of control. With reference to the first of the above advantages, it has not usually been considered desirable to wind these motors direct for line pressure, the excessive vibration to which they are subject, and the impracticability of having them under continued expert supervision, rendering it practically necessary to insert a main transformer between line and motors so as to confine the region of high potential to the simplest and most reliable of appliances. The motors now being built by the Allgemeine Electricitäts Gesellschaft for the South London line of the London, Brighton and South Coast Railway, are of the

LOCOMOTIVES AND MOTOR CARRIAGES

Winter-Eichberg type, and a main transformer is included in the equipment between the line and motors, the latter being wound for a reasonably low voltage.

The Winter-Eichberg type of motor, which is supplied in this country by the British Thomson-Houston Company, consists of a stator more or less resembling that of an ordinary polyphase induction motor, and carrying a single-phase winding. The rotor is similar to the armature of a continuous-current machine, except that the commutator is larger in proportion. Short-circuited brushes bear on the commutator at the centre of the poles, and exciting brushes at the neutral point. There is thus rather a large amount of brush gear, and the losses due to brush friction and contact resistance are somewhat excessive—requiring a large commutator, which in any case is very liable to run hot.

The Compensated-Series Type of Single-Phase Commutator Motor.

The compensated-series type of alternating current railway motor is a development of the series motor as used for continuous currents. The latter motor, if provided with a completely laminated magnetic circuit, could be operated from an alternating-current power supply, but necessarily offers so high an impedance as to have an exceedingly low power factor, whilst very poor commutation is to be expected, and altogether such a motor is impracticable, except in very small sizes. Recognising the need of diminishing the effect of armature reaction in this type of motor, Lamme¹ introduced longitudinal slits or holes in the pole pieces, in order to impose reluctance in the path of the armature flux, and in some of the holes placed copper bars, connected together so as to form short-circuited coils at right angles to the armature flux, the current induced in which tends still further to cut down the cross-magnetisation of the armature. In order to improve the commutation of the machine, Lamme adopted the well-known expedient of inserting high-resistance leads between the armature coils and the commutator bars. Finzi, of Milan, independently investigated the series motor for traction purposes, and also adopted the expedient of dividing the pole pieces across the path of the armature flux, and of inserting high-resistance commutator leads, but did not employ compensating coils. His motor is, therefore, not a compensated motor, but nevertheless appears satisfactory for small tramway sizes. Shortly after this, the General Electric Company of America took up the development of the alternating-current series motor, and their engineers appear to have been amongst the first to fully realise the importance of the arrangement of the compensating winding. Instead of bunching this in one slot in the centre of each pole, as in Lamme's motor, they distributed it uniformly over the stator face, connecting it in series with the armature, and arranging to have practically the same number of ampere-conductors per unit of peripheral length in the compensating as in the armature winding. The compensating winding was of course connected so as everywhere to oppose the armature field with an equal field, thus completely neutralizing the armature reaction. The distributed compensating winding has now been generally adopted for this type of motor.

The compensated-series type of motor, which is shown diagrammatically in Fig. 362, is distinguished from the above-mentioned repulsion types in having its range of practicable and efficient speed, from synchronism to some two or two and a half times synchronous speed. Its efficiency is somewhat higher than, whilst its

¹ See British Patent 2,746. 1902.

ELECTRIC RAILWAY ENGINEERING

average power factor is quite as high as, that of the Latour-Winter-Eichberg type,

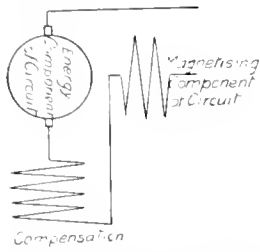

Fig. 362. COMPENSATED SERIES TYPE OF SINGLE-PHASE COMMUTATOR MOTOR.

(Westinghouse (Lammie).—The compensation is obtained by the current in the stationary series windings wound in slots in the surface of the pole shoes and in quadrature with the main field winding. In the earlier form, the compensation was obtained by the current induced in a compensating winding short-circuited on itself.)

and considerably higher than the pure repulsion type. Compared with the continuous-current series motor, it has a rather weak field and proportionally large armature reaction, which is taken care of by the compensating field. This type of motor is well suited for use as a continuous-current motor, although for this purpose it is of advantage to employ a stronger field. The General Electric Company of America have accordingly adopted the practice of winding the exciting coils in sections, which are put in series for continuous-current working and in parallel for alternating-current working. As a continuous-current motor, the compensated series motor has a higher efficiency and greater capacity than when used as an alternating-current motor, although it falls short of the ordinary continuous-current railway motor in these respects.

The following description of the motor and its auxiliaries, and of the method of control, applies to a 75 h.-p. motor designated G.E.A. 605, as manufactured by the General Electric Company in America, and by the British Thomson-Houston Company in England. The motor is illustrated in Figs. 363, 364, 365, and 366, and an assembly drawing giving the main dimensions is shown in Fig. 367.

It is designed to operate at from 200 to 250 volts, taking power at a frequency of 25 cycles per second. The rating is 75 h.-p. at

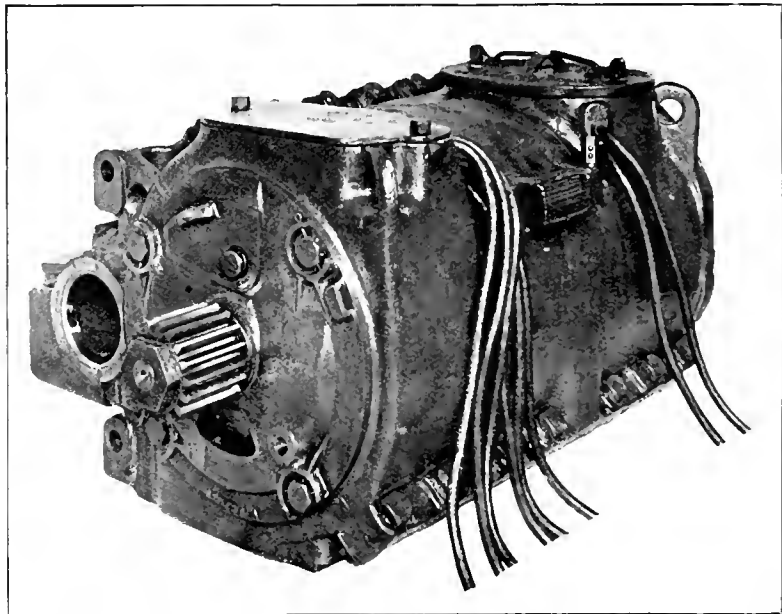

Fig. 363. ASSEMBLY OF BRITISH THOMSON-HOUSTON CO.'S COMPENSATED SERIES SINGLE-PHASE RAILWAY MOTOR.

Rating as a continuous-current motor on the one-horn 75 deg. Cent. standard, is 75 h.-p. at 200 volts.

LOCOMOTIVES AND MOTOR CARRIAGES

200 volts when operating as a continuous-current motor, and on the basis of 75 Cent.

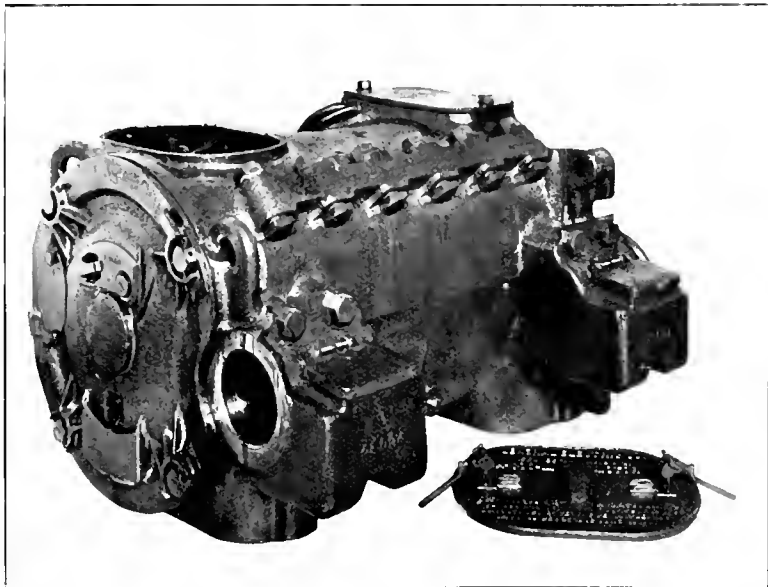

Fig. 364. ASSEMBLY OF BRITISH THOMSON-HOUSTON Co.'s COMPENSATED SERIES SINGLE-PHASE RAILWAY MOTOR.

rise after one hour's run, as defined by the American Institute of Electrical Engineers Committee of Standardisation.¹

The frame of the motor is made of steel and is split diagonally, the two sections being bolted firmly together. The frame encloses and holds securely the laminated field structure. At the ends of the frame are large bored openings, into which malleable iron frame heads carrying the armature shaft bearings are bolted. Through these openings, the armature is put in place or removed from the frame.

A large aperture is provided in the frame above the commutator, through which the commutator can be inspected or the brush gear adjusted. The opening is closed by a malleable iron cover with a felt gasket—the cover being held in place by a quickly adjustable cam-locking device.



Fig. 365. FIELD FOR BRITISH THOMSON-HOUSTON Co.'s COMPENSATED SERIES SINGLE-PHASE RAILWAY MOTOR.

¹ Transactions A.M. Inst. Elec. Engrs., Vol. XIX., p. 1083.

LOCOMOTIVES AND MOTOR CARRIAGES

completely neutralise the armature reaction, which would otherwise cause field distortion and result in sparking at the commutator. The compensating winding also materially improves the power factor, by reducing the inductive drop. The exciting windings are arranged in two circuits, which are connected in parallel for alternating-current operation, and in series for continuous-current operation. The winding is insulated with mica, asbestos, and specially prepared fabric, which makes it semi-fireproof and practically impervious to moisture.

The exciting field has 24 turns, wound in 24 brass slots spaced so as to form 4 poles. The compensating field has 60 turns wound in 60 slots in laminations distributed uniformly over the pole face. Dimensions of the slots: 1.47 in. by 0.49 in. by 0.22 in. Pole arc = 86 per cent. Both compensating and exciting windings are made of 0.5 in. \times 0.12 in. copper bar.

The armature closely resembles the standard continuous-current railway armature. The connection is four-pole multiple drum, and the armature is bar wound—a large number of single-turn coils being employed for the purpose of improving the commutation. The bars are separately insulated with mica and are assembled in sets, which are then insulated as a whole with mica, and covered with an outside protective covering of specially prepared tape.

The diameter of the armature is 16 in., the gross core length 19 in., there being 55 slots each, of size 1.59 in. \times 0.54 in. There are no ventilating ducts provided in the armature.

The radial depth of iron below the slots is 2.41 in. The winding has one turn per coil and 6 conductors per slot, the size of the conductor being 0.55 in. \times 0.11 in. The average length of air gap is 0.11 in.

The construction of the commutator is similar to that of standard continuous-current railway motors. The segments are of hard drawn copper, insulated throughout with the very best grade of mica, of such hardness as to wear down evenly with the copper. The commutator ears into which the armature conductors are soldered, are formed integral with the segments. The diameter of the commutator is 13.25 in., and it has 165 segments.

There are four brush holders, mounted on a revolving yoke, and each containing four carbon brushes. The holders are made of cast bronze, and are supported on mica-insulated studs, bolted to the revolving yoke. The brushes slide in finished ways, and are pressed against the commutator by independent fingers, which give practically uniform pressure throughout the working range of the brush. The size of brush is $1\frac{7}{8}$ in. by $\frac{3}{8}$ in.

The frame heads carrying the armature shaft bearings are extended in cone shape well under the commutator shell and pinion-end armature core head. This construction forms a support for the bearing linings, which are very strong and rigid. The heads have large oil wells, into which oily wool-waste is packed and comes into contact with a large surface of the armature shaft, through an opening cut in the low pressure side of the bearing linings. The armature shaft linings are unsplit bronze sleeves finished all over, having a thin layer of babbitt metal soldered to the interior. The babbitt furnishes an ideal bearing surface, and is so thin that it does not allow the armature to rub on the poles in case it is melted out by overheating. Waste oil is prevented from reaching the vital parts of the motor by means of a series of oil deflectors, which throw the oil into large grooves cast in the bearing heads, from which it is conducted to drip-cups cast on the outside of the heads. The bearing boxes are practically the same as standard car axle boxes,

ELECTRIC RAILWAY ENGINEERING

and are reached through large hand holes protected by swing covers, held in place by springs.

The axle linings are in two segments and are held in place by cast steel caps, which are tongued and bolted to planed and grooved surfaces on the frame. Large oil wells are cast in the caps, into which is packed oily wool-waste which comes into contact with a large surface of the axle through openings cut in the bearing linings.

The gear is made of a superior grade of cast steel, and contains 73 teeth of 3 diametral pitch. It is of the split type, accurately bored and provided with a keyway for securing to the axle. The pinion is of forged steel, extra hammered to improve the quality of the metal. It contains 17 teeth, and has a taper fit on the

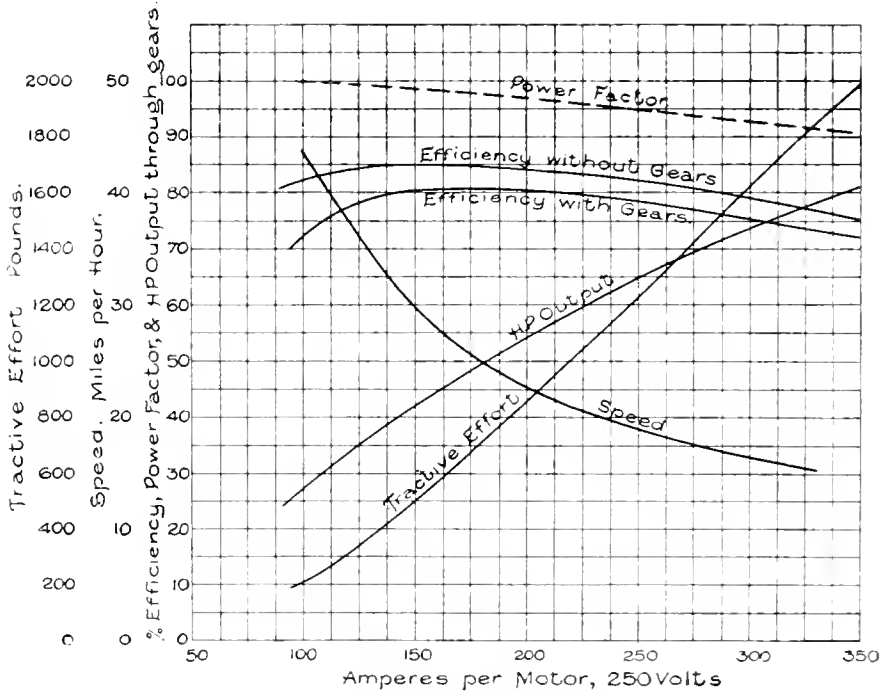

Fig. 368. G.E.A. 605 RAILWAY MOTOR. CHARACTERISTIC CURVES ON 250-VOLT ALTERNATING-CURRENT CIRCUIT, 25 CYCLES. EFFICIENCY CORRECTED FOR A COPPER TEMPERATURE OF 75° CENT. 33-INCH WHEELS 73:17 GEAR. (BRITISH THOMSON-HOUSTON CO.)

armature shaft of $\frac{3}{8}$ in. to the foot measured radially. The gear ratio is 4:3. The gear case is strongly made of malleable iron, with a substantial form of support.

The following are the weights of the motor, excluding pinion, gear, and gear case:—

Frame	1,934 lbs.
Field	1,217 lbs.
Armature	1,143 lbs.
Total	4,294 lbs.

The characteristic curves of this motor are shown, for alternating-current operation, in Fig. 368, and for continuous-current operation in Fig. 369.

LOCOMOTIVES AND MOTOR CARRIAGES

The method of control applied to these motors is shown diagrammatically in Fig. 370, which shows the connections for four motors with controller and compensator.

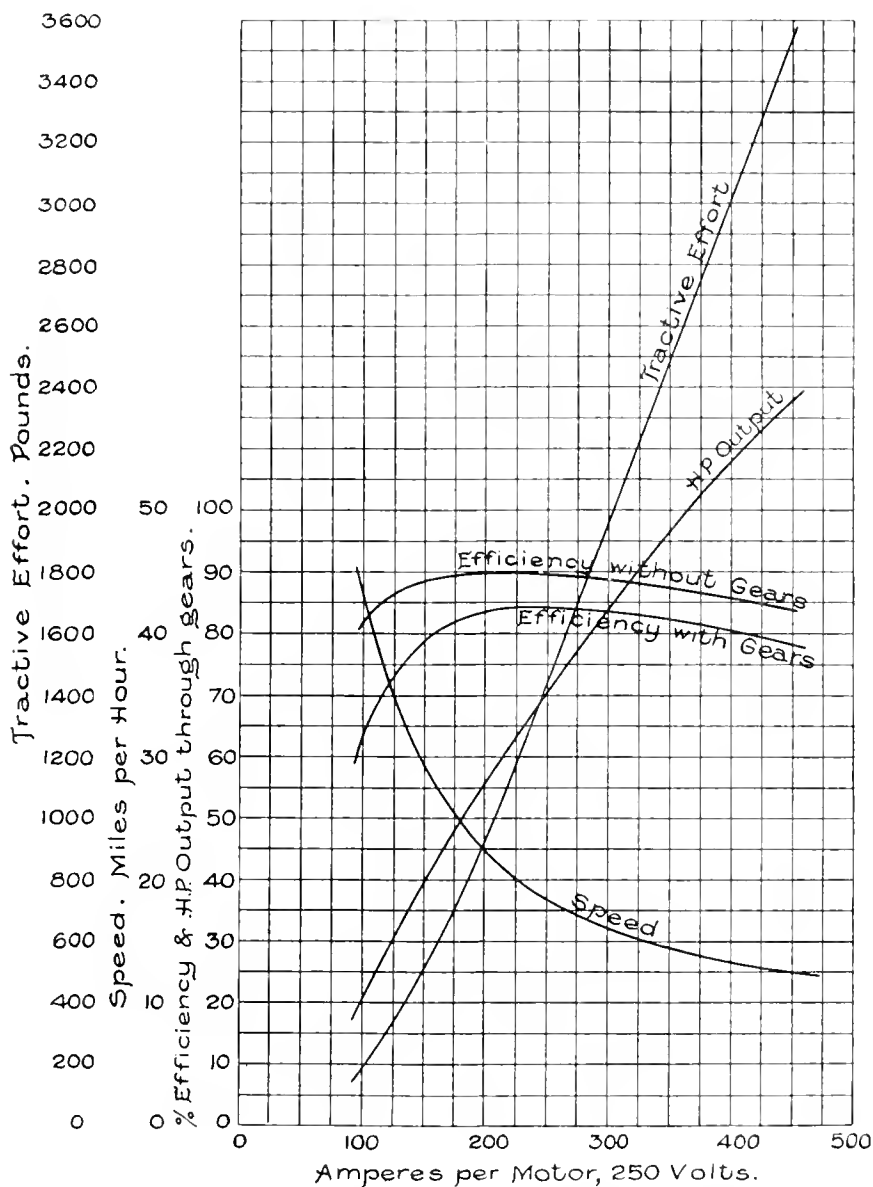

Fig. 369. G.E.A. 605 RAILWAY MOTOR. CHARACTERISTIC CURVES ON 250-VOLT CONTINUOUS-CURRENT CIRCUIT. EFFICIENCY CORRECTED FOR A COPPER TEMPERATURE OF 75° CENT. 33-INCH WHEELS 73/17 GEAR (BRITISH THOMSON-HOUSTON Co.).

For alternating-current working, the motors are connected permanently in series, the circuit connections leading first through the field windings of the four motors, and then in series through the armatures and their compensating windings.

ELECTRIC RAILWAY ENGINEERING

The speed variations are obtained by varying the voltage across the group of

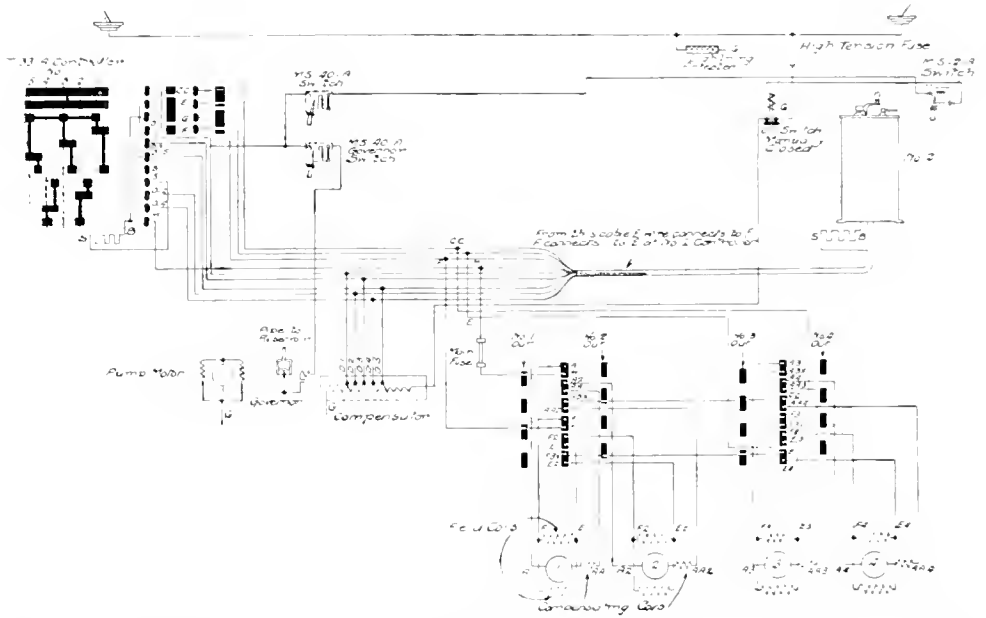

Fig. 370. CAR WIRING FOR T-33 A CONTROLLERS WITH FOUR G.E.A. 605 COMPENSATED MOTORS FOR A.C. OPERATION (BRITISH THOMSON-HOUSTON Co.).

four motors, by connecting with different taps of the compensator or auto-transformer. The latest form of compensator is shown in Fig. 371, and is of the oil-cooled type.

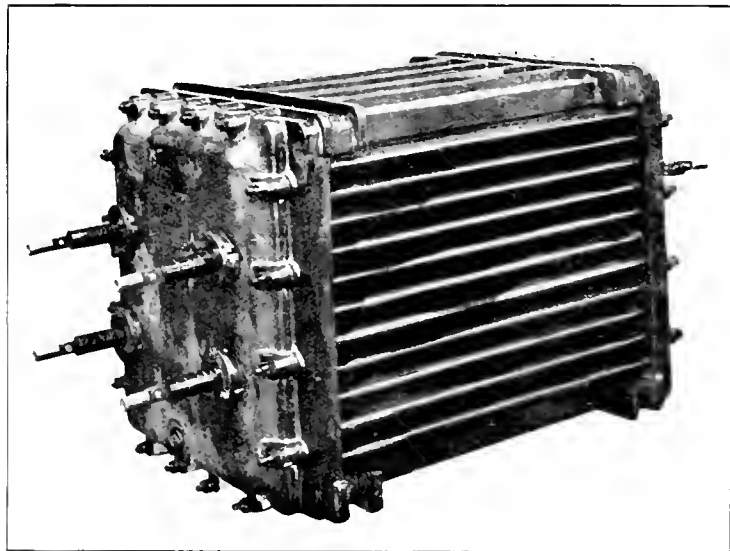

Fig. 371. BRITISH THOMSON-HOUSTON Co.'s LATEST FORM OF OIL-COOLED COMPENSATOR, AS EMPLOYED IN SINGLE-PHASE RAILWAY SYSTEM.

LOCOMOTIVES AND MOTOR CARRIAGES

A diagram of connections for a multiple-unit system of control is shown in Fig. 372, in which the various circuit connections are made by means of contractors

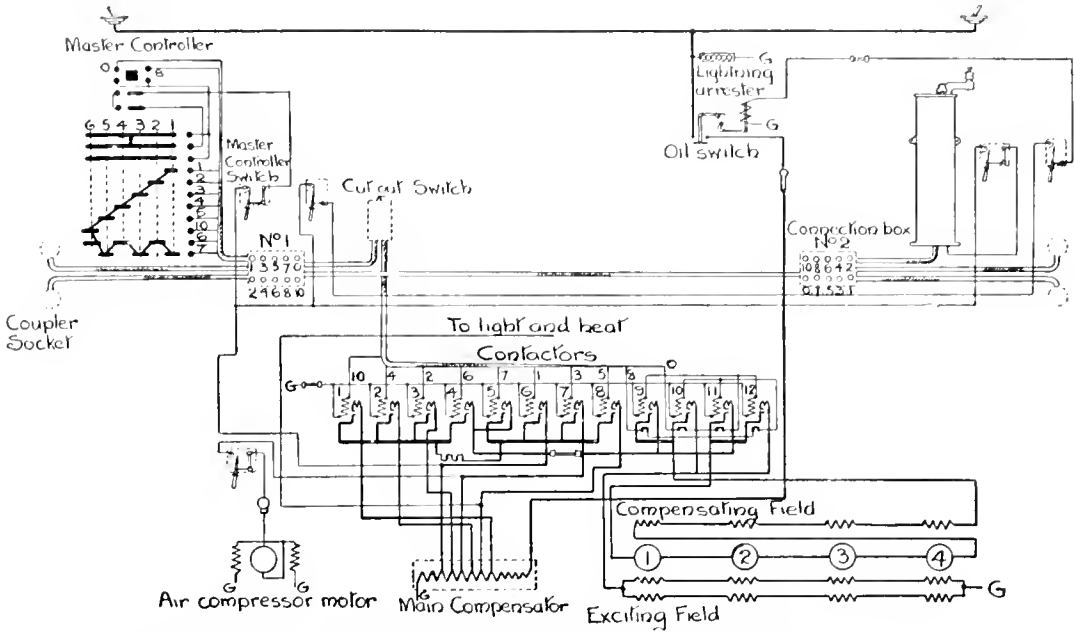

Fig. 372. DIAGRAM OF CONNECTIONS OF BRITISH THOMSON-HOUSTON CO.'S SINGLE-PHASE RAILWAY SYSTEM AS ARRANGED FOR THE MULTIPLE-UNIT SYSTEM OF CONTROL.

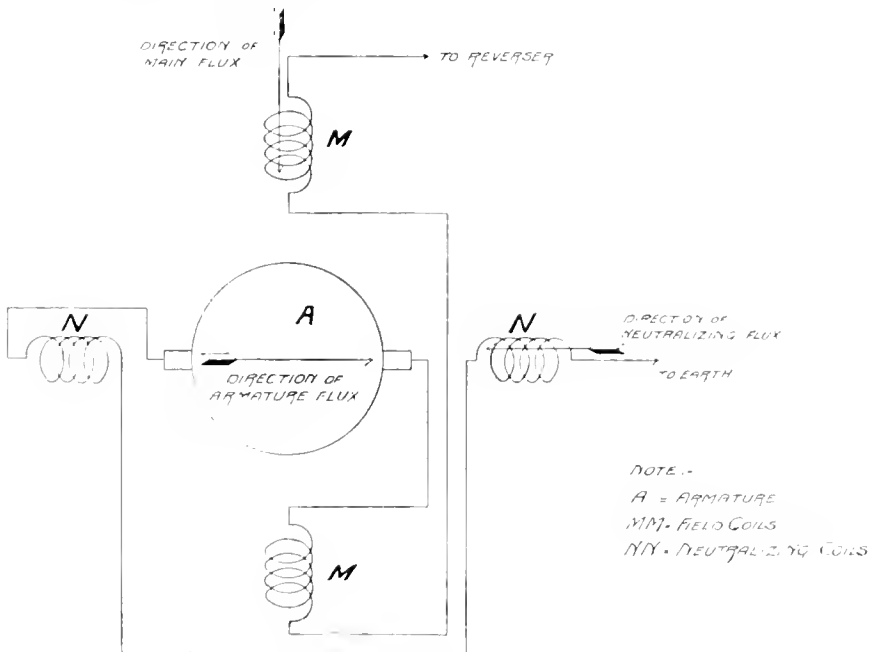

Fig. 373. DIAGRAM OF BRITISH WESTINGHOUSE ELECTRIC AND MANUFACTURING CO.'S SINGLE-PHASE SERIES MOTOR, WITH FORCED NEUTRALISING WINDING, AND SHOWING NORMAL DISTRIBUTION OF MAGNETIC FLUX.

ELECTRIC RAILWAY ENGINEERING

energised by a small master controller, instead of being made directly by the controller.

This motor, in common with others of this type, will operate equally well on a

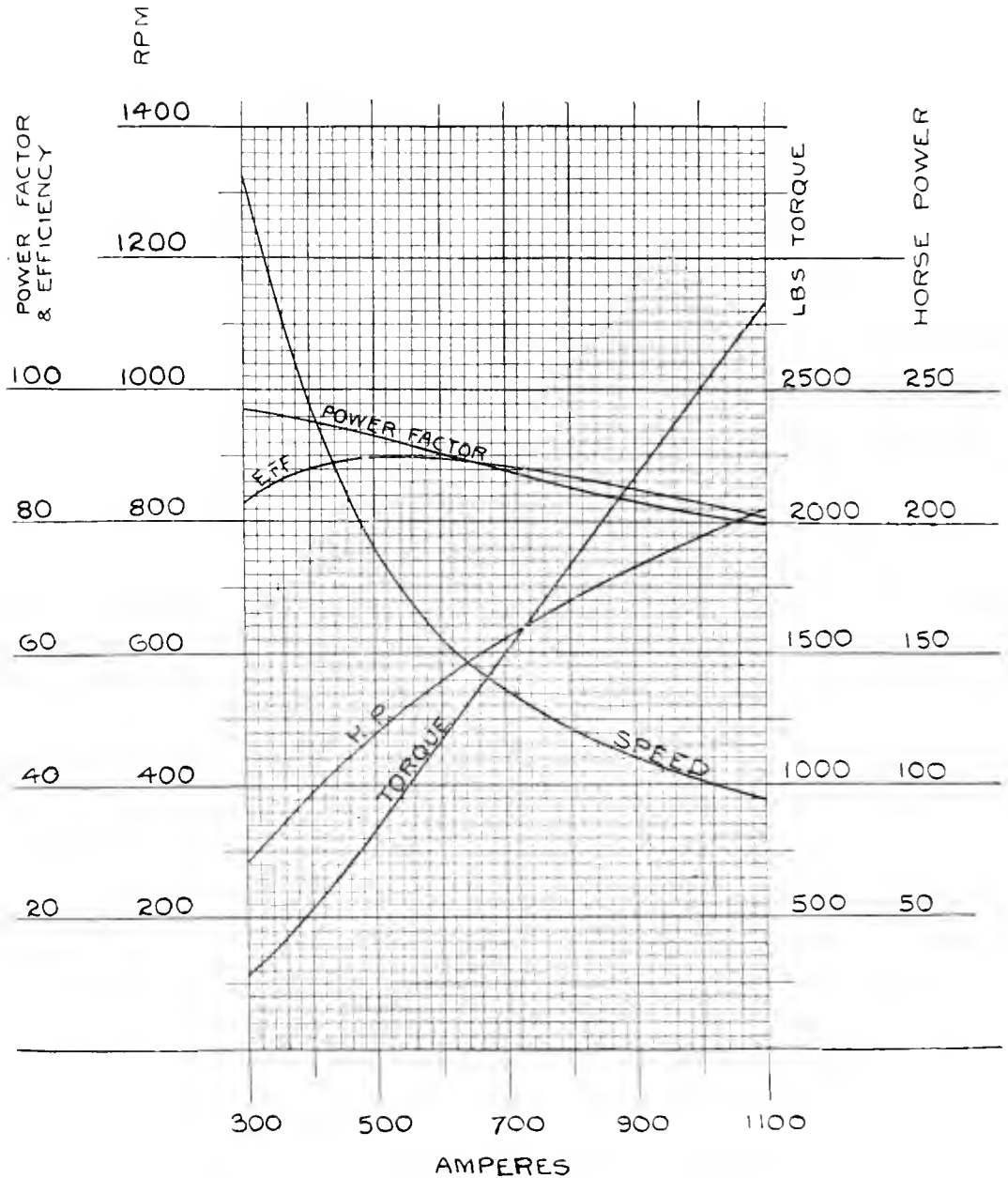

Fig. 371. CHARACTERISTIC CURVES OF BRITISH WESTINGHOUSE ELECTRIC AND MANUFACTURING Co's STANDARD SINGLE-PHASE RAILWAY MOTOR.

continuous-current circuit. The modifications which are necessary for adapting the equipment for continuous-current working from a 500 to 600 volt circuit, consists in

LOCOMOTIVES AND MOTOR CARRIAGES

grouping the motors in sets of two, connected in series, and operating the groups in series or in parallel by means of the ordinary series parallel control. A special commutation switch is employed for making the necessary changes in connections in passing from alternating to continuous current working, or *vice versa*.

In the Westinghouse system the high voltage line current is reduced to a suitable pressure for use by the motors, by means of an auto-transformer. The motors themselves are of the series type with forced neutralising winding embodied in the stator, illustrated in diagrammatic form in Fig. 373. In general, with good climatic conditions and line voltages up to about 6,600, the air blast type of transformer is

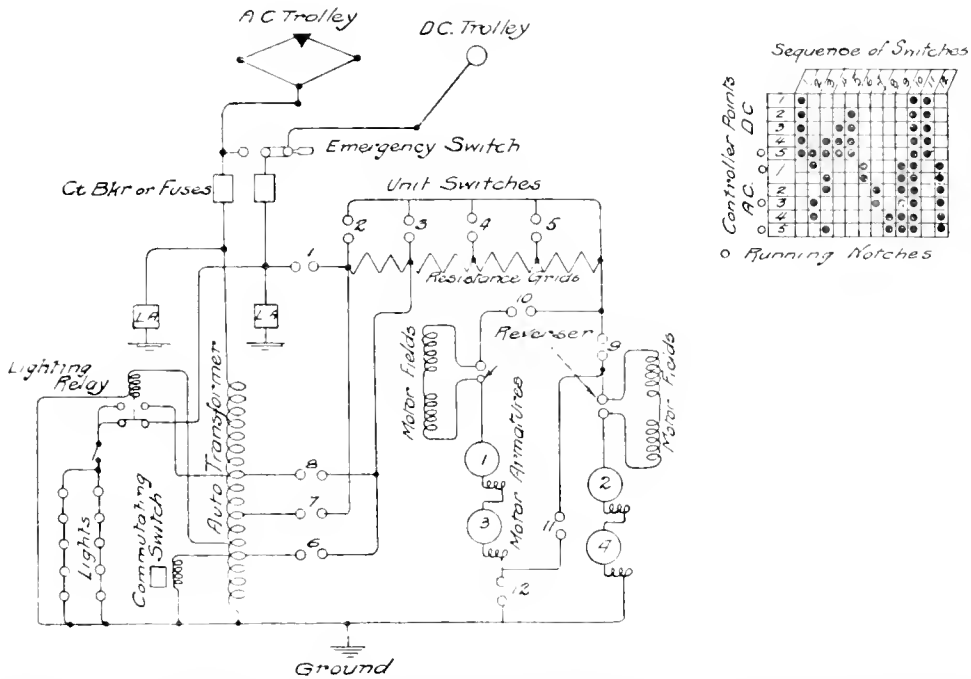

Fig. 375. BRITISH WESTINGHOUSE ELECTRIC AND MANUFACTURING CO.'S SINGLE-PHASE MOTORS AND CONTROL EQUIPMENT CONNECTIONS FOR WORKING ON ALTERNATING-CURRENT OR CONTINUOUS-CURRENT CIRCUITS.

used, whilst with higher voltages or bad climatic conditions, such as working in damp tunnels, etc., the oil insulated, self-cooling type of transformer is used.

Figure 374 shows curves of speed torque, power factor, efficiency, and horse-power for the standard 150 h.-p. Westinghouse motor.

No change is made in the motor for working on alternating or on continuous current. The neutralising winding on the field frame is permanently in series with the armature, and is retained in use whilst working on continuous current since it tends to improve the commutation of the motor under that condition. Fig. 375 shows the connections of the motor and control equipment for working on alternating and on continuous current.

Figure 376 shows the connections for multiple-unit train control.

In the 150 h.-p. motor the weight of the stator is approximately 3,900 lbs. and that of the armature approximately 1,500 lbs. The pinion, gear, and gear case weigh

ELECTRIC RAILWAY ENGINEERING

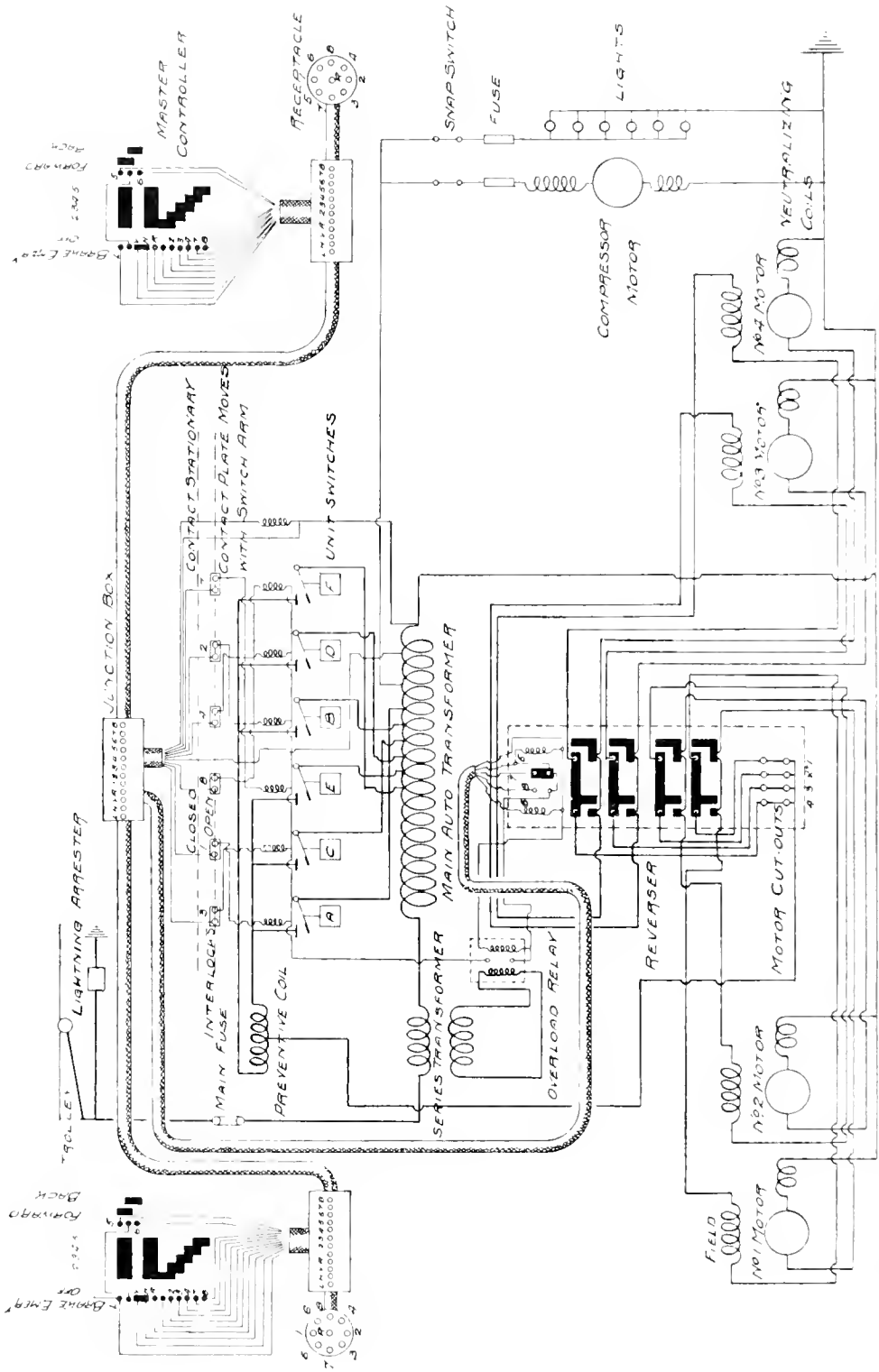

Fig. 376. BRITISH WESTINGHOUSE ELECTRIC AND MANUFACTURING CO.'S WIRING DIAGRAM FOR A MOTOR COACH EQUIPPED WITH SINGLE-PHASE SERIES MOTORS AND ELECTRO-PNEUMATIC MULTIPLE-UNIT CONTROL SYSTEM.

LOCOMOTIVES AND MOTOR CARRIAGES

about 600 lbs., making the total weight of the motor complete about 6,000 lbs. This motor is designed for working both on alternating and continuous current.

The motor is of the single-phase series wound railway type, designed to operate with alternating current, and has speed and torque characteristics similar to those of a continuous current series motor. The voltage applied to the motor is about 250 to 260 volts as against 620 volts for continuous current motors. This considerably reduces the liability of damage to insulation.

The nominal one-hour rating is 150 h.-p. At this load, when supplied with alternating current at 260 volts 25 periods per second, the motor is stated to take 670 amperes and will have an efficiency of 89 per cent. and a power factor of 88.5 per cent. at a speed of 570 r.p.m. Under these conditions the temperature rise, after a one hour's run on the testing stand, is stated not to exceed 75° C. by thermometer

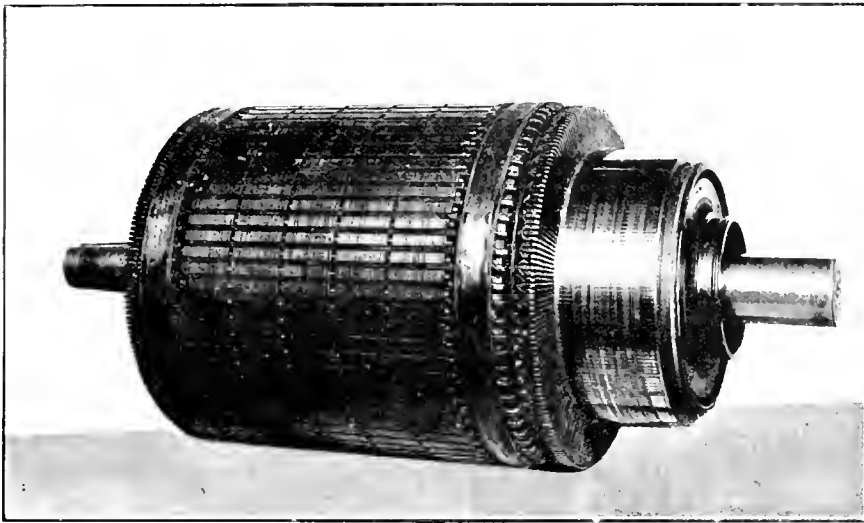

Fig. 377. ARMATURE OF BRITISH WESTINGHOUSE ELECTRIC AND MANUFACTURING Co.'s
150 H.-P. SINGLE-PHASE RAILWAY MOTOR.

measurement. The continuous capacity of the motor is given as 330 amperes at 125 volts.

The motor frame consists of a cast steel yoke into which soft steel punchings are dovetailed and securely clamped, producing a magnetic circuit which is completely laminated.

There are six brush holders, each with two carbon brushes, the current density in which, at normal rated load, is 65 amperes per square inch. Flexible shunts are fixed to the brushes to relieve the springs from carrying current. The brush holders are adjustable, thus allowing compensation for the wear of the commutator.

The motor is held on the axle by means of axle caps split at an angle of about 35°, the caps being below the axle and the frame above. The opposite side of the motor is arranged for nose suspension.

All the bearings are made of phosphor bronze and are arranged for oil waste lubrication, having oil reservoirs of ample capacity. The armature bearings are 4 in. × 7 $\frac{3}{4}$ in. and 4 $\frac{1}{2}$ in. × 10 $\frac{3}{4}$ in. respectively.

ELECTRIC RAILWAY ENGINEERING

There are six main field coils wound with copper strap and insulated with mica. Each coil is held rigidly in position on its pole by hangers, independent of the pole pieces.

The neutralising winding consists of copper bars placed in slots in the pole faces, and is insulated in the same way as for the main field coils. This winding is so arranged that it need not be disturbed when removing the field coils.

The armature core is built up of soft steel punchings assembled on a cast iron spider. The shaft, which is made of open hearth steel, is pressed into the spider with a pressure of from 20 to 30 tons and is also secured by steel keys. The winding is placed in partially closed slots in the core with three layers in each slot, one of

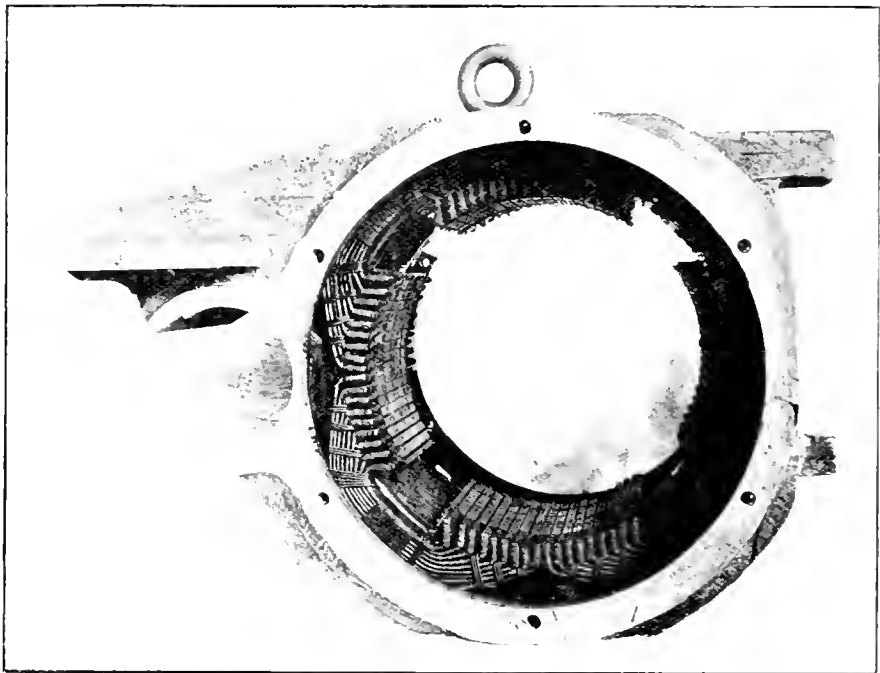

Fig. 379. FIELD FRAME OF BRITISH WESTINGHOUSE Co.'s 150 H.P. SINGLE-PHASE RAILWAY MOTOR WITH THE NEUTRALISING WINDINGS ONLY IN PLACE.

which constitutes the lead to the commutator, and has relatively high resistance, which acts as a preventive lead whilst the coil is being short-circuited under the brushes. Each conductor is insulated along its entire length by overlapping layers of mica tape, and each group in each slot is further insulated from the core by being supported in a moulded mica cell. The completed winding is held firmly in position on the core by insulated wedges, and the ends are banded down on the coil supports.

The commutator is made of rolled and hard drawn copper, clamped in V-shaped cast steel rings. The insulation between the bars is formed with specially prepared material of such hardness as to ensure its wearing at the same rate as the copper. The complete commutator is pressed on the spider which holds the armature core.

The photograph in Fig. 377 shows the complete armature.

The pinion is made of forged steel with machine-cut teeth, and the gear wheel

LOCOMOTIVES AND MOTOR CARRIAGES

is made of cast steel with machine-cut teeth. The gears have a diametrical pitch of $2\frac{1}{2}$ in. and 5 in. width of face.

It is stated that the completed motor will stand a momentary puncture test of 2,000 volts alternating E.M.F.

Figure 378 shows an assembly drawing of the motor, whilst the photographs in Figs. 379 and 380 show the field frame. The former shows the frame with the

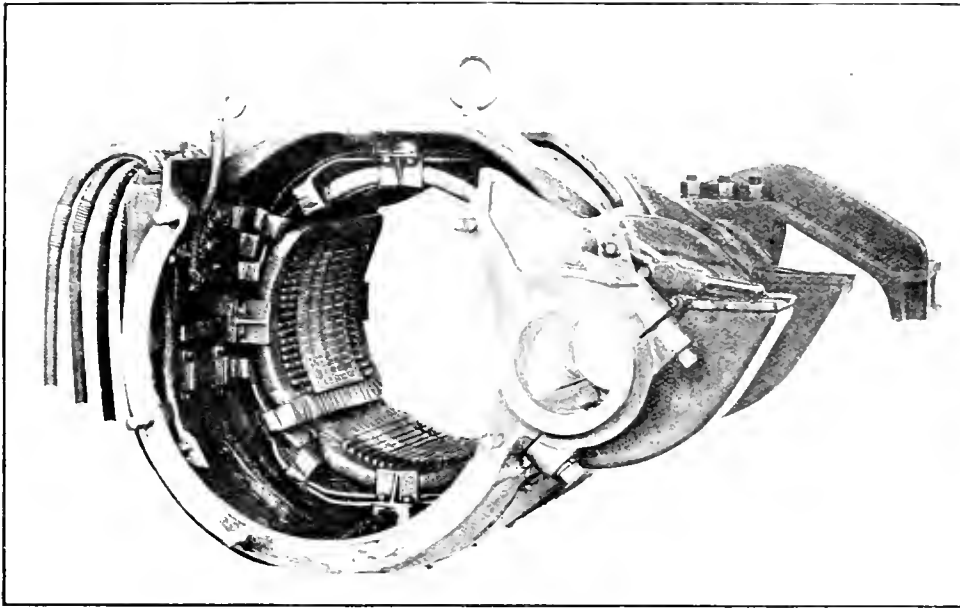

Fig. 380. FIELD FRAME OF BRITISH WESTINGHOUSE CO.'S 150 H.P. SINGLE-PHASE RAILWAY MOTOR WITH BOTH THE NEUTRALISING WINDINGS AND THE MAGNETISING COILS IN PLACE.

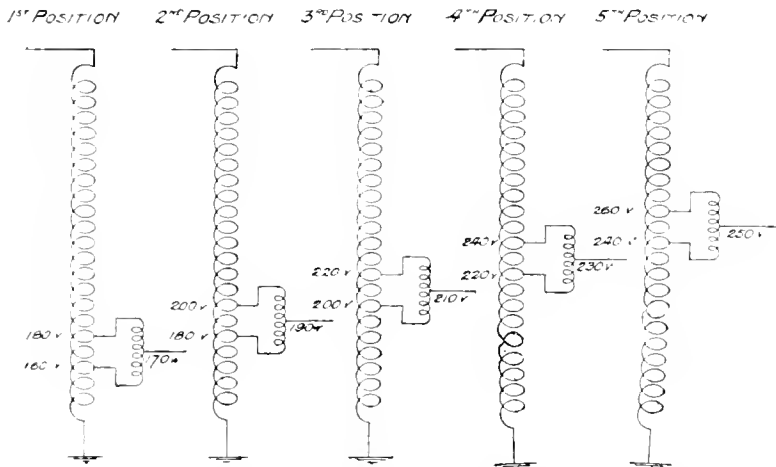

Fig. 381. DIAGRAM, SHOWING RELATIVE ELECTRICAL CONNECTIONS BETWEEN AUTO-TRANSFORMER AND PREVENTIVE COIL AND VOLTAGES APPLIED TO MOTORS FOR THE SEVERAL POSITIONS OF MASTER CONTROLLER (BRITISH WESTINGHOUSE ELECTRIC AND MANUFACTURING CO.).

ELECTRIC RAILWAY ENGINEERING

neutralising windings only in place, and the latter the frame with the field coils also in position. It will be noticed that the field coils can be removed without interfering with the neutralising winding.

The function of the auto-transformer is to transform the line voltage, which in

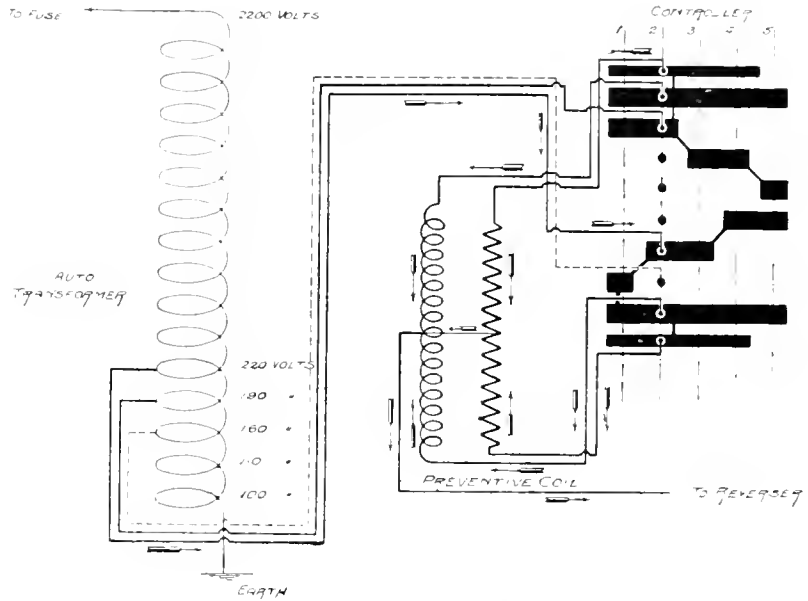

Fig. 382. DIAGRAM, SHOWING DISTRIBUTION OF CURRENT WITH CONTROLLER IN SECOND POSITION (BRITISH WESTINGHOUSE ELECTRIC AND MANUFACTURING CO.).

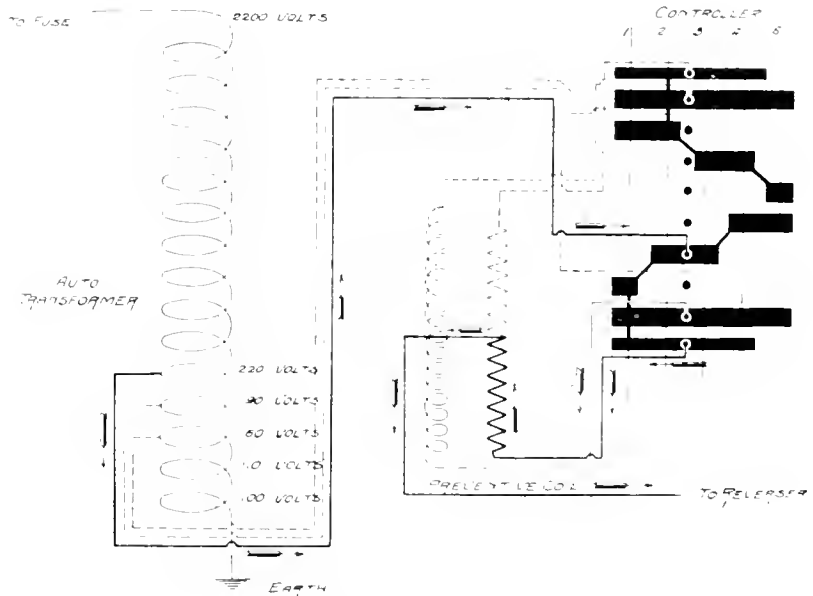

Fig. 383. DIAGRAM, SHOWING DISTRIBUTION OF CURRENT WITH CONTROLLER IN TRANSITION FROM SECOND TO THIRD POSITION (BRITISH WESTINGHOUSE ELECTRIC AND MANUFACTURING CO.).

LOCOMOTIVES AND MOTOR CARRIAGES

practice varies from 3,300 volts to 18,000 volts, according to the magnitude of the undertaking, to the low voltage required by the motors (160 to 280 volts). The transformer is of the single-winding type, in which one end of the winding is connected to the trolley and the other is permanently connected to earth. At the earthed end of the winding, various taps are brought out, giving suitable voltages for supply to the motor terminals, as illustrated in Figs. 381, 382 and 383. Auto-transformers are usually made either of the air blast type, in which case the air blast is furnished by a small motor-driven fan mounted in the case of the transformer; or else of the

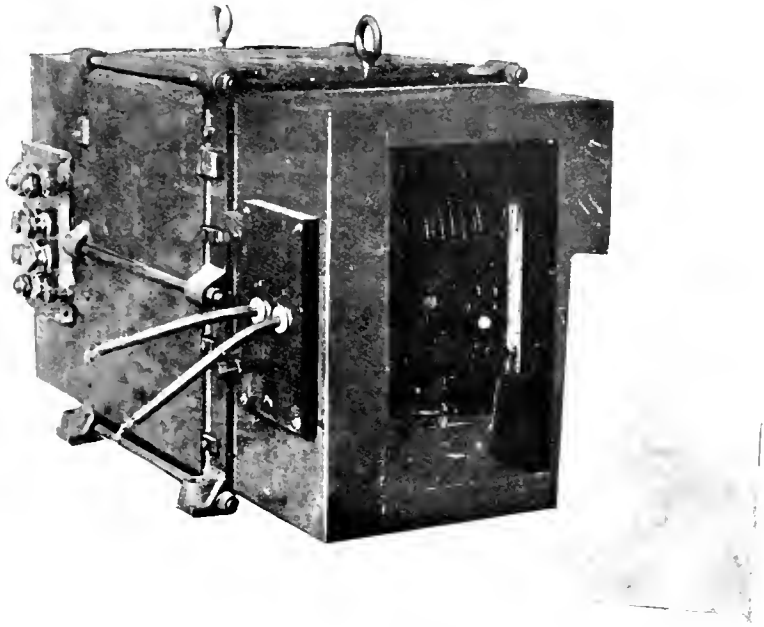

Fig. 384. PHOTOGRAPH OF THE HIGH-TENSION END OF AN AIR-BLAST TYPE OF AUTO-TRANSFORMER, AS EMPLOYED IN THE BRITISH WESTINGHOUSE CO.'S SINGLE-PHASE RAILWAY SYSTEM.

oil-insulated, self-cooling type, in which case the transformer winding is wholly immersed in insulating oil carried in a metal case.

The photograph in Fig. 384 illustrates the high tension end of an air-blast auto-transformer, and Fig. 385 gives the outline of an oil-insulated auto-transformer.

The unit switches shown in Fig. 386 take current from the various low tension tappings of the auto-transformer and deliver it to the motors. These switches are caused to open or close by air pressure acting on small pistons. The compressed air is admitted to, or released from, each unit-switch cylinder by means of a small pin valve which is operated by an electro-magnet. The electro-magnet is controlled by the motorman by means of the master controller. The electro-pneumatic control of the unit switches is common not only to this system but to the Westinghouse continuous-current railway controllers and the Westinghouse railway signalling system. With this system of control, the unit switches and reversers throughout a train are made to move in unison under the action of one master controller, by means of a small multicore cable which connects all the master controllers, switch groups, and

ELECTRIC RAILWAY ENGINEERING

reversers, on a train in parallel. This multicore cable is joined up between cars by plug-and-socket and flexible connections.

In operation, two of the unit switches are always closed whilst the master

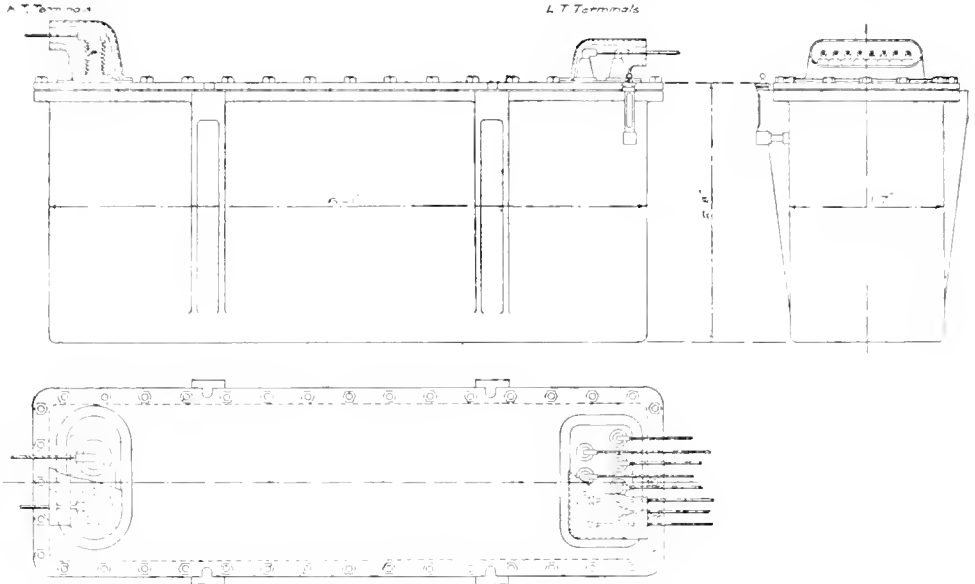

Fig. 385. OUTLINE DRAWING OF OIL-INSULATED AUTO-TRANSFORMER BY THE BRITISH WESTINGHOUSE ELECTRIC AND MANUFACTURING Co.

controller is on a running point, and the current which they furnish is led to the two ends of the preventive coil.

The preventive coil is used for the reason that it permits the circuit to the motors to be maintained unbroken when passing from one voltage to a higher or

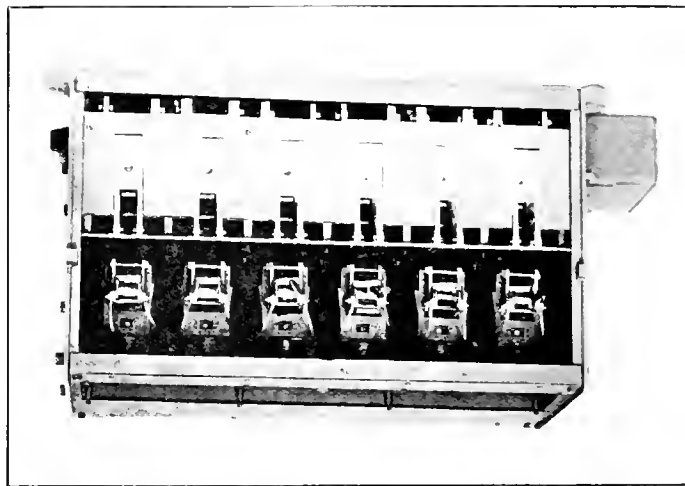

Fig. 386. ELECTRO-PNEUMATICALLY-CONTROLLED UNIT SWITCHES, AS EMPLOYED IN THE BRITISH WESTINGHOUSE Co.'S SINGLE-PHASE RAILWAY SYSTEM.

LOCOMOTIVES AND MOTOR CARRIAGES

lower voltage tap, since two of the unit switches can be closed simultaneously without local currents between them being developed.

The reverser receives current from the preventive coil and delivers it to the

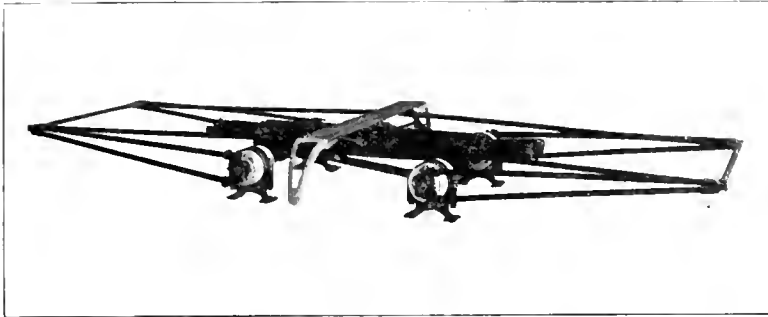

Fig. 387. BRITISH WESTINGHOUSE CO.'S SELF-REVERSING PANTOGRAPH TROLLEY.

motors, which are connected in parallel. The reverser is connected in such a way as to reverse the fields of the motors and not the armatures. The reverser is operated by means of air pressure acting on pistons controlled by electromagnets on the same system as described above in the case of the unit switches. An interlock on the reverser makes it impossible for any current to be delivered to the motors until the reverser has been thrown in the right direction. The movement of all the reversers on a train is effected simultaneously, as in the case of the unit switches, through the movement of the master controller.

The master controller consists of a very small drum-type controller. The handle is moved to the right or left according to the direction in which it is desired to move the train. In Fig. 376 there is shown a diagrammatic development of the master controller, in which the successive running positions, from one to five, are clearly indicated together with the different switch combinations. Owing to the fact that the voltage on the motor terminals is varied by varying the

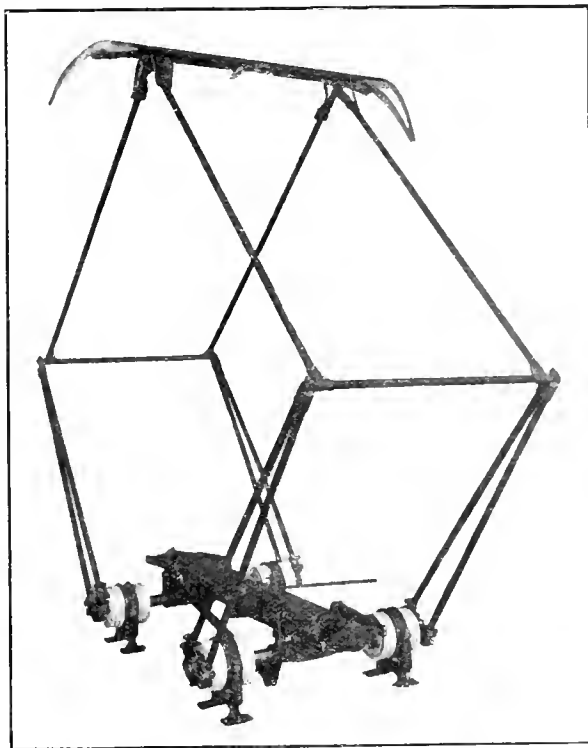

Fig. 388. BRITISH WESTINGHOUSE CO.'S SELF-REVERSING PANTOGRAPH TROLLEY.

ELECTRIC RAILWAY ENGINEERING

connections from the auto-transformer, and not by the interposition of resistance, as in the case of continuous-current railway practice, every notch on the master controller is a running notch, and the train can be held at the corresponding speed for any length of time without rheostatic losses.

In the case of small cars operating at moderate speeds, a wheel type of trolley may be used, provided that it is thoroughly insulated from the car body. On the heavier types of vehicle and on locomotives the self-reversing pantograph trolley has been found most successful. Photographs of this type of trolley are given in Figs. 387 and 388. The pantograph type of trolley is suitable for the highest speeds, as, owing to its great width, there is no possibility of its jumping the trolley wire. The trolley is of the self-reversing type and is brought up into the running position

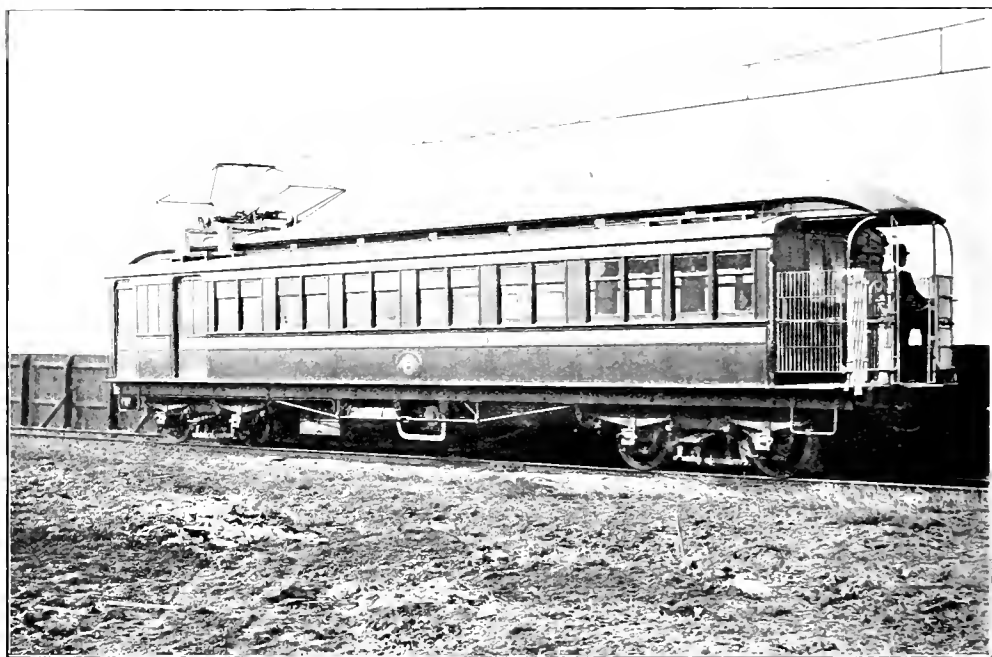

Fig. 389. BRITISH WESTINGHOUSE CO.'S EXHIBITION CAR AT TRAFFORD PARK, MANCHESTER.
The car is equipped with the British Westinghouse Co.'s Single-Phase Railway System.

in contact with the trolley wire, or withdrawn, so as entirely to isolate the car from the high tension supply circuit by means of air pressure. The control of this air pressure is effected by means of a special three-way cock fitted in the driver's cab.

Fig. 389 is a photograph of the exhibition car at the Trafford Park Works of the British Westinghouse Electric and Manufacturing Company. The car is equipped with four 100 h.-p. single phase railway motors and with the electro-pneumatic multiple-unit switch control. The trolley pressure on this exhibition line is 3,300 volts, and the car is fitted with ammeters, voltmeters, and wattmeters for making complete observations.

The several types of single-phase traction motor have been somewhat hastily reviewed, for, while their properties are of great interest, the fact of greatest present

LOCOMOTIVES AND MOTOR CARRIAGES

commercial significance is that the net results are strikingly alike in all types. Their respective features of superiority and inferiority are of a minor character, and largely offset one another. Hence we may, in much of the following discussion, allude to the "single-phase commutator motor" as having certain properties, without reference to the particular type.

The "single-phase commutator motor" may be said to be characterised by the following features of inferiority:—

A considerable loss by hysteresis and eddy currents in the stator, not present in the continuous-current series motor.

In all types, a greater commutator loss due to the desirability, if not *necessity*, of employing a lower commutator voltage than is customary in the continuous-current motor.

In the Latour-Winter-Eichberg motor, a still farther commutator loss due to the extra short-circuited brushes.

An efficiency at all loads, and particularly at light loads, considerably inferior to that of the continuous-current series motor.

Commutation decidedly inferior, at any rate at starting with heavy torque, to that obtained in the continuous-current series motor.¹

A considerably larger and more expensive commutator than is employed in the continuous-current motor.

Chiefly on account of the larger internal losses, a considerably larger, heavier, and more expensive design in general, than for the continuous-current motor.

A greater liability to breakdowns between turns in the field windings than in the continuous-current series motor, even when much more liberally insulated, and a temporary complete disablement of the motor when such a breakdown occurs, whereas in the continuous-current motor a short-circuited field turn does not disable the motor.

A power factor averaging, in actual service, considerably less than unity.

An amount of auxiliary apparatus on the train, greatly exceeding in weight and cost, that employed for the continuous-current series motor.

By these means there have been obtained—

A speed torque characteristic about equivalent to that of the continuous-current series motor.

Regulation by voltage control, thus dispensing with rheostatic losses.

Ability to transmit by high tension alternating current right through from powerhouse to train, any desirable intermediate transformations of voltage being accomplished by means of stationary transformers, thus avoiding expensive and inefficient rotary converter or motor-generator sub-stations.

¹ The coil short-circuited under the brushes constitutes, at the moment the motor is thrown on the line, a stationary secondary circuit in which large currents are induced by the alternating magnetic flux. As the motor starts, the armature turns successively occupy and depart from this position, and occasion considerable sparking as well as a considerable I²R. loss. In discussing this point, Lamme states (American Institution of Electrical Engineers, January 29th, 1904):—"The short-circuit current at start is one of the most serious conditions which confront us in alternating current motors, and is also of great importance where there is any considerable operation on low speeds. The speaker advocates a type which he considers gives the easiest condition in this regard. This short-circuiting cannot be entirely avoided in any of the motors brought out, without adopting abnormal and questionable constructions, although devices like narrow brushes, sandwich windings, etc., have been proposed."

ELECTRIC RAILWAY ENGINEERING

Although progress in the development of the single-phase commutator motor has been rapid, it would appear unreasonable to look forward to very considerable further improvements in those respects where it is still distinctly inferior. On the other hand, not only are there also numerous undeveloped features in the continuous-current railway motor, but there are other single-phase railway systems where the motors driving the train need not, and probably would not, be of the single-phase commutator type. One very meritorious and promising system of this kind is that developed by the Oerlikon Co., where the motors driving the train are of the continuous-current type. In this system, the locomotive carries a single-phase motor, preferably of the synchronous type, which drives a continuous-current generator, the voltage of which is varied by field control. The speed of the motors driving the locomotive or car-axles is thus effectively controlled without the use of rheostats, and regenerative braking is exceedingly simple and effective. The continuous-current motors need not be located exclusively on the locomotive, but may, in the interests of obtaining a high rate of acceleration, be distributed on the trucks of the carriages, thus securing some important advantages of the multiple-unit system. In the Oerlikon system, a high efficiency during acceleration is obtained, for whatever the rate of acceleration, and whatever the current consumed by the driving motors, the current drawn from the line is proportional merely to the current consumed by the traction motors plus the internal losses in the motor-generator set, and no energy is wasted in rheostats or other controlling devices. This system has been illustrated in Figs. 316 and 317, on pp. 351 and 352.

Wherever alternating current may come to be employed for railway electrification, the importance of low periodicity should not be underestimated. It is true that this involves still heavier transformers and other control apparatus, but it is also true that the chief consideration is the production of a light and efficient motor with high power factor, a small diameter, and a reasonably deep air gap. The fulfilment of these requirements involves a reduction in the size of the commutator and of the commutator losses without sacrifice of good commutating qualities. To reduce the size of the commutator and the commutator losses the use of a higher commutator voltage is necessary, and this will be the more practicable the lower the frequency. With a lower frequency, a good power factor may also be obtained with a deep air gap; and a smaller rotor diameter will be consistent with a good design.

In the design of the commutatorless induction motor, high rated speed is attended with advantages more or less equivalent to those associated with low periodicity. This is not the case with the single-phase commutator motor, for the use of a commutator involves the necessity of keeping within moderate speeds, if the best results are to be secured, and a low frequency becomes all the more important.

The economic speed of the single-phase commutator motor, while lying considerably below that of the induction motor, will nevertheless be higher than that of the continuous-current motor, for the reason that the voltage causing sparking, depends, not upon the speed alone, but has a component, which is independent of the speed, generally considerably larger than the reactance voltage.

In Fig. 390 are given comparative curves of efficiency of continuous-current and single-phase commutator motors, the efficiencies in both cases corresponding to the highest speed notch of the controller. The continuous-current motor has only one other really efficient position, the full series, and intermediate positions involve rheostatic losses. The single-phase motor, on the other hand, has, in virtue of the method of regulation by voltage control, a separate efficiency curve with a fairly high point of maximum efficiency, corresponding to every controller notch. This is

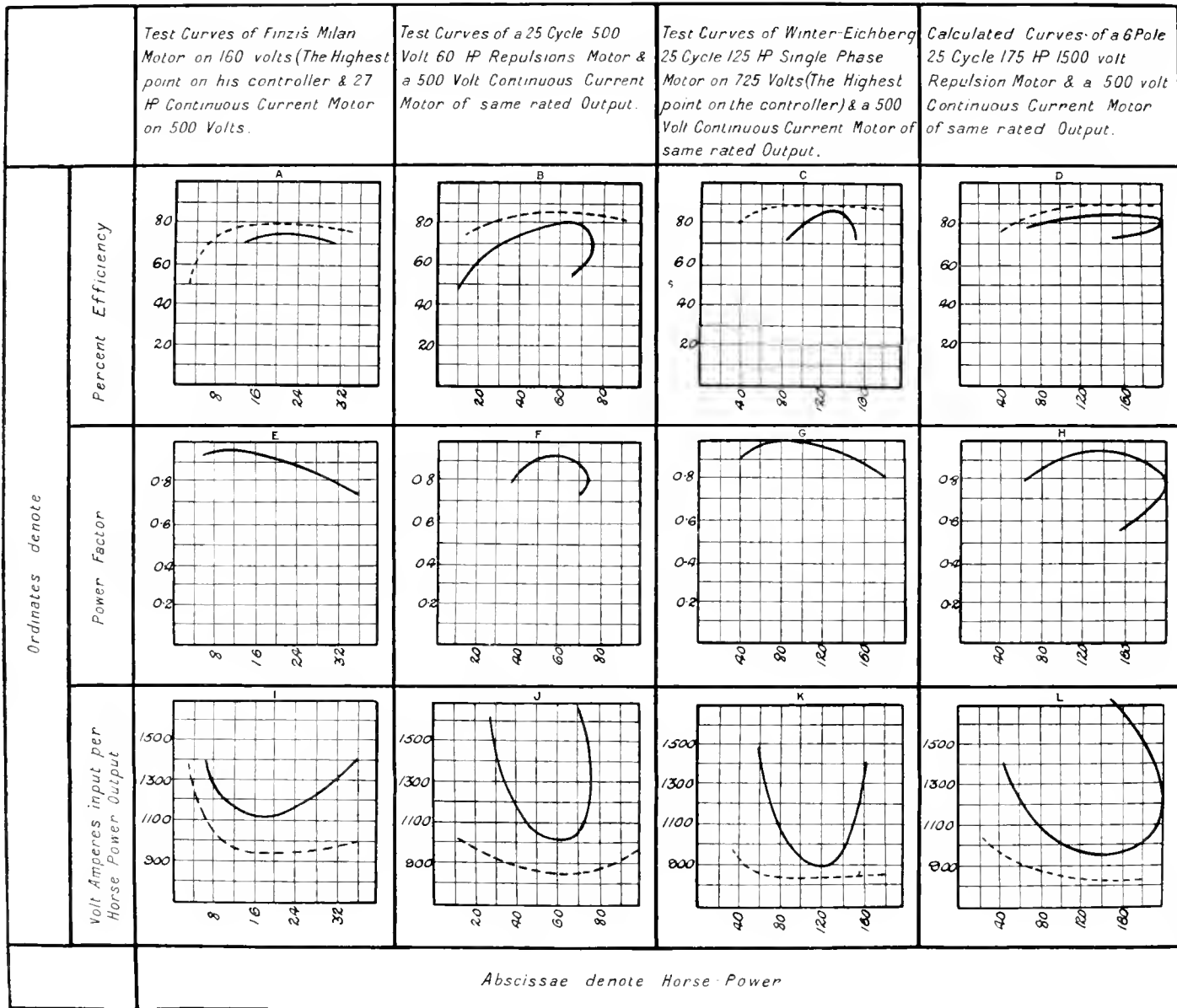

Fig. 390. SOME CHARACTERISTIC CURVES OF SINGLE PHASE COMMUTATOR MOTORS (FULL LINE CURVES) AND CONTINUOUS CURRENT MOTORS (BROKEN LINE CURVES).

LOCOMOTIVES AND MOTOR CARRIAGES

illustrated in Fig. 391, which represents a group of efficiency curves of the same Latour-Winter-Eichberg motor for which the efficiency at the highest notch has been given in Fig. 390.

Thus, while the maximum efficiencies of single-phase commutator motors are considerably lower than the efficiency of the continuous-current motor on the running

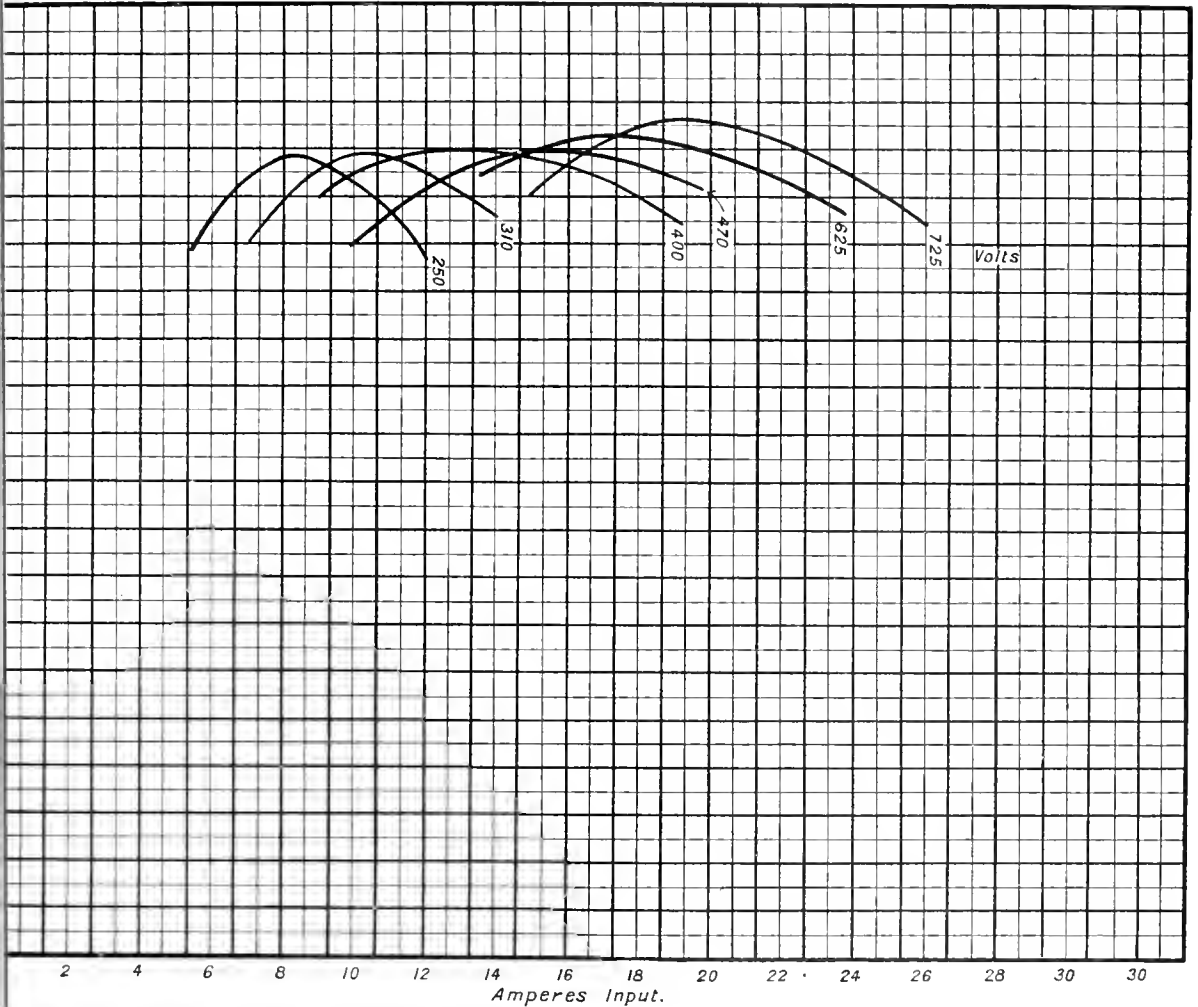

Fig. 391. EFFICIENCY CURVES OF LATOUR-WINTER-EICHBERG MOTOR.

points of the controller, this is partly made up for by the greater number of efficient running points in the single-phase system.

Attention should be drawn to another point, namely, the maximum output of the two types of motor. While, as is well known, the output of the continuous-current series motor is limited only by the heating, the maximum output attainable by the single-phase commutator motor is, for any voltage, sharply defined. A glance at the second and fourth vertical columns of Fig. 390 shows that these two repulsion

ELECTRIC RAILWAY ENGINEERING

motors, rated respectively at 60 h.-p. and 175 h.-p., cannot, at the highest voltage, carry overloads exceeding 25 per cent. and 15 per cent. respectively, whereas, with continuous-current motors for these rated outputs, momentary overloads of 100 per cent. and more, occasion no difficulty. When the curves of single-phase motors are plotted with amperes as abscissæ, as in Fig. 392, this limiting overload is not so clearly apparent; it is only evident that the current increases rapidly with decreasing speeds. The efficiency curve of Fig. 392 is merely transformed from the corresponding curve of Fig. 390.

The power factors corresponding to the same four motors are given in the second horizontal row of Fig. 390, and from these, together with the efficiency values, the curves in the lower horizontal row of Fig. 390 have been prepared, showing the volt-amperes required per horse-power developed, by the continuous-current and the

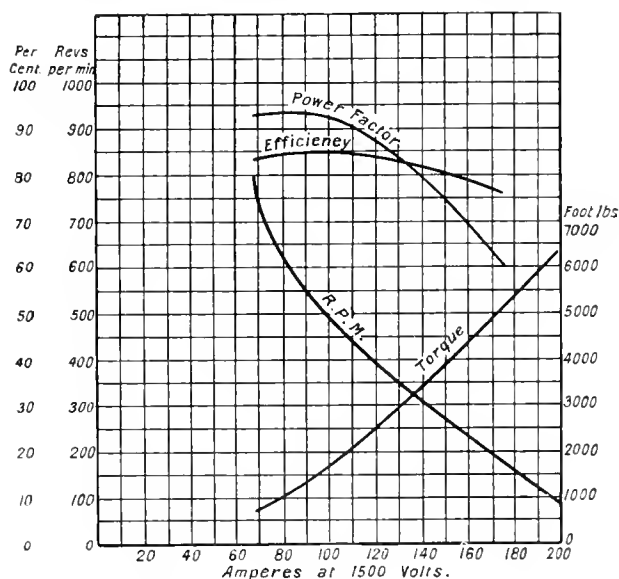

Fig. 392. CALCULATED CURVE OF 175 H.-P. REPUulsion MOTOR AT 1,500 VOLTS.

running at speeds below the point of unity power factor, and thus will be taking a lagging current from the line, other motors will be running above the point of unity power factor, and will be taking a leading current from the line. By intelligent operation, the lagging and leading currents may largely neutralise one another on a fairly extensive system, and thus the generating plant might, under favourable conditions, be designed for approximately unity power factor. This is a most important feature, reducing, as it may, the capital outlay for the generating plant and the transmission system.

There is, of course, much to be said on behalf of the single-phase system, but since this system has most strenuous advocates, it is not proposed to go into the question further than has already been done, since it is believed that, in spite of the necessity, in the interests of an intelligent comparison, of calling attention to some weak points of the single-phase system heretofore overlooked, its merits have also been fairly admitted. It is to be hoped that further progress in the improvement of the single-phase motor may lead to the production of a thoroughly satisfactory system for the purposes of the electrical operation of main line railways. For dense service,

LOCOMOTIVES AND MOTOR CARRIAGES

however, there appears to be no sufficient reason to look for the early supersession of the continuous-current motor.

We thus see that the most unsatisfactory aspects of the single-phase system relate to the rolling stock equipment.

The use of high tension continuous current, on the other hand, affords a sound engineering basis for railway electrification. On p. 360 allusion was made to propositions on these lines as laid down by one of us some years ago. Although at that time the proposition met with no encouragement, a very considerable revulsion of opinion has lately taken place, and the subject of high voltage continuous current railway electrification is now beginning to attract the very considerable attention which it merits. Under these circumstances the writers have sought and obtained the courteous permission to reproduce the article in question.

The Continuous-current System and the Single-phase System for Traction.

Many hundreds of thousands of continuous-current railway motors are now in use, and are giving excellent satisfaction. The field of operation for electric traction has been rapidly extended, and it has encroached heavily upon the suburban and inter-urban traffic heretofore handled exclusively by the main steam lines.

The replacement of steam by electric traction on main lines is still of doubtful economic practicability, although much attention has been given to the subject.

The economic impracticability of operating main lines electrically has related chiefly to the difficulty of obtaining any approximation to a uniform load, for, providing the traditional limit of 650 volts at the train is accepted, the sub-stations cannot be many miles apart, and at the customary spacing and speed of through trains, a sub-station will be alternately running idle for long intervals and loaded for short intervals. Several times more capacity of sub-station apparatus will, therefore, be necessary than would be the case could the same amount of work be done at a uniform rate. Moreover, the average efficiency is excessively low, owing to the large constant losses in such a large installation of lightly loaded machinery. At first sight, the natural solution would appear to be to operate by single cars instead of by trains. While this would greatly improve the load factor, it would increase by from 100 per cent. to 200 per cent. the work required to be done per ton hauled a given distance¹ at a given speed. This would at any rate be the case at speeds above 50 miles per hour. Furthermore, there would inevitably be greater danger and expense in operating at a schedule speed of 60 miles per hour, six carriages at 5-minute intervals, as against one train per half-hour. Were it not for the enormously increased friction incurred by single-car operation, this would, however, be the plan which would be followed; and it may, to some extent, indicate the lines on which main roads will ultimately be operated.

An increased permissible voltage would permit of fewer, larger, more uniformly loaded, and more economical sub-stations situated at greater distances apart.

The possibilities in this direction, as associated with the use of continuous-current motors, have been but little considered. The hopelessness of the case from the standpoint of any such low voltage as 650 has generally led to the expectation that some solution by alternating current motors would ultimately be found. A good

¹ Armstrong, "High Speed Electric Railway Problems," American Institute Electrical Engineers (June 30th, 1903).

ELECTRIC RAILWAY ENGINEERING

deal of tentative work with three-phase motors has been carried out during the last few years, but the difficulties associated with two insulated conductors, lack of speed flexibility, and a number of other disadvantages more or less consequent upon the latter, have sufficed to dampen the enthusiasm of many engineers who were originally very sanguine along these lines.

The application of the commutator to the polyphase motor afforded considerable promise of giving it greater speed flexibility. Hardly, however, was this appreciated before the *single-phase* commutator motor was brought to a commercial stage of development. This naturally concentrated attention upon the problem of the single-phase operation of main line railways, for the single-phase commutator motor not only affords speed flexibility, but also avoids the necessity for two insulated conductors.

It is reasonable to base upon these developments, renewed hopes of solving the problem of the electrical operation of main lines. Is it, however, reasonable or just to the continuous-current motor to disregard its undeveloped possibilities, especially in the matter of operation at higher voltage? Aside from the question of main line traction, there is a large field for interurban electric traction and for extensive urban and suburban systems. Doubling or trebling the voltage at the train would at once immensely extend the range of economic working. There are the further possibilities associated with two commutators, or even two motors in series, and treated as a single unit. Series-parallel control is well within the range of the practicable at such voltages; indeed, the controller problem is, in some respects, simplified by the reduction of the current through increased voltage. But in high speed suburban and interurban work, with infrequent stops, rheostatic control need detract but slightly from the efficiency,¹ and as it is for just such work that the higher voltages are desirable, the argument would, from the continuous-current motor's standpoint, be but slightly impaired by the assumption of rheostatic control.

It appears the more desirable to speak on behalf of the continuous-current motor in this connection since, contrary to expectations, it is not so much for main line work, but more especially for urban, suburban, and interurban work, that the single-phase motor is at present being strongly advocated.

Thus Mr. P. M. Lincoln² states:—"Interurban electric traction work is, in my opinion, the peculiar field for the alternating current system"; also, "When stops are few, and consequently runs are long, . . . the advantage of the alternating current system is not so greatly marked. With short runs, on the other hand, and consequently frequent starts, . . . the alternating current system can have the greater advantage."

Mr. B. G. Lamme states:—"It thus appears that, while suburban work was once thought to be the most important field for the single-phase railway, it has now become evident that city work, where traffic is very congested in parts of the system, will prove to be one of the best fields for this system."³

¹ With correctly designed modern motors, the necessary speed variation at constant load may be obtained by a rheostat in parallel with the field, and hence efficiently.

² *Electrical World and Engineer*, December 12th, 1903.

³ In the same article (*Electrical World and Engineer*, December 26th, 1903). Mr. Lamme also states:—"Of course, it is recognised that for heavy railroad service, where all kinds of speeds should be obtained economically, the single-phase railway system will undoubtedly show to great advantage compared with any known continuous-current system. But, as considerable time will be required to equip any railroad service, it is probable that the single-phase railway system will be well tried out before there is a good opportunity to give it a thorough trial for heavy work."

LOCOMOTIVES AND MOTOR CARRIAGES

Armstrong and others see the greater possibilities in main line work, and this would seem to be the sounder position.

Inasmuch as superior merits for the crowded traffic conditions of large cities have been claimed for the single-phase commutator motor, it is of interest to compare the respective features of the continuous-current and the single-phase motor, since for crowded city work the former is at present exclusively employed.

For a given voltage, the single-phase motor has the larger commutator, in order to take care of additional parasitic losses.¹ The satisfactoriness of the design of the single-phase commutator motor is so dependent upon low voltage, that considerably less than 500 volts is advocated for some types, and is probably desirable for all. This leads to a further increase in size of commutator, and in the magnitude of the commutator losses. The more recent types of single-phase motors have an extra set of short-circuited brushes, thus two sets of brushes per pole, as against one set per pole for the continuous-current motor. The commutation will not be better than for the continuous-current motor.

The field spools of the alternating current motor have much the higher voltage per turn, and a breakdown in the insulation between one turn will occasion heavy induced currents in the short-circuited turn, promptly leading to the disablement of the motor for the time being. Such a breakdown does not result from the short-circuiting of a single field turn in a continuous-current motor.

The internal losses inherent to the single-phase motor are, according to rated capacity, periodicity, speed, and voltage, at least from 15 per cent. to 35 per cent. greater than for the equivalent continuous-current designs.² Szasz (*Zeitschrift für Elektrotechnik* for November 22nd, 1903, pp. 651—653) estimated that the losses in the single-phase commutator motor are much in excess of these figures. The motor must consequently be larger and heavier or run warmer for a given performance. The efficiency is consequently considerably less. It has been pointed out by Szasz in the article above referred to, that in the compensated type of single-phase motor the efficiency falls off badly above and below certain very limited conditions of load for given ratios of transformation. This is also evident from Figs. 393 and 394. Hence a good deal of intelligence would require to be exercised by the driver in operating on the most efficient controller notches for all conditions. Szasz points out that the efficiency curve of the continuous-current series motor is far better sustained throughout a wide range of conditions.

¹ These, and practically all the disadvantages of the single-phase motor, have been admitted by its advocates with commendable frankness.

² Lamme states the efficiency of the single-phase motors to be from 1 per cent. to 5 per cent. less than that of the continuous-current motor (*Electrical World and Engineer*, December 26th, 1903, pp. 1043—1046). In this article Lamme gives the following useful summary of the component losses in the single-phase commutator motor:—

(1) Iron loss due to reversals of magnetism in armature and field at the frequency of the supply circuit:

(2) Armature iron loss due to variations in magnetism, dependent upon rotation of the armature:

(3) Iron loss in the surface of the field and armature due to the bunching of magnetic lines from the teeth of either element:

(4) Losses in field windings;

(5) Loss in armature windings;

(6) Brush losses;

(7) Friction and windage.

And on comparing each in turn he shows that, of these seven component losses, only one, the fourth, is as low as in the continuous-current motor.

ELECTRIC RAILWAY ENGINEERING

The inferiority of the single-phase commutator motor as regards efficiency may be seen from Figs. 393 and 394, relating respectively to the Winter-Eichberg¹ motor and the Finzi motor. The curves in Fig. 393 are taken from Mr. Eborall's recent paper entitled "Electric Traction with Alternating Currents." The full line curves relate to the efficiency of the single-phase, and the dotted curve to the efficiency of an equivalent continuous-current motor. In Fig. 394 the full line curve represents the efficiency of the Finzi motor tested at Milan, and the dotted curve represents the efficiency of an equivalent continuous-current motor. The data for Dr. Finzi's motor are derived from Diagrams 1 and 2 of the *Electrical Review* of November 13th, 1903, Vol. LIII., p. 769. The continuous-current motor used in this comparison is a standard

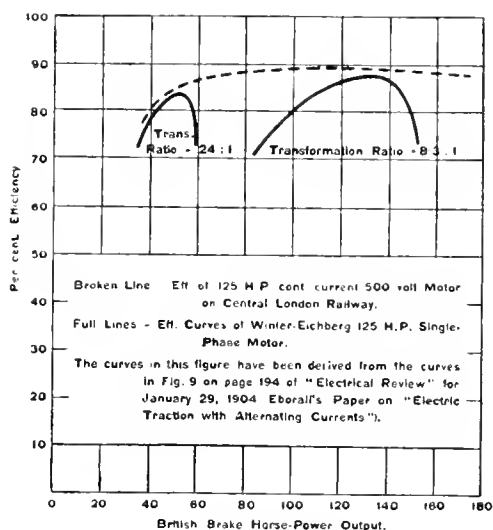

Fig. 393. COMPARISON OF EFFICIENCIES OF CONTINUOUS-CURRENT AND SINGLE-PHASE MOTORS.

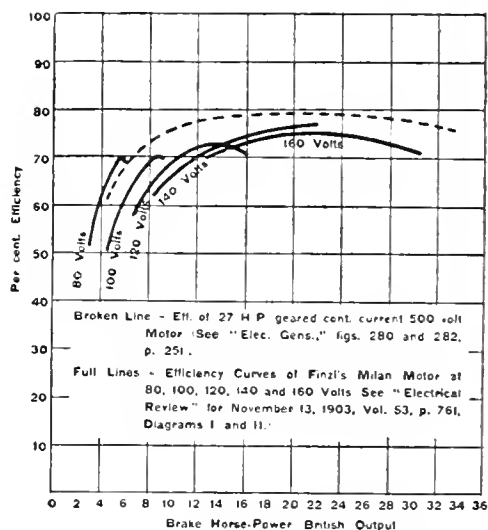

Fig. 394. COMPARISON OF EFFICIENCIES OF CONTINUOUS-CURRENT AND SINGLE-PHASE MOTORS.

27 h.p. motor for which efficiency and output curves are given in Figs. 281 and 283 on p. 276 of "Electric Machine Design."²

The power factor of the single-phase commutator motor falls considerably short of unity for all except a very narrow range of loads. In the case worked out by Mr. Lincoln the average power factor at the generators is 0.85. The power factor during acceleration is exceedingly low.

For the single-phase system considerable auxiliary apparatus is required on the car. This consists chiefly of step-down transformer and voltage regulator. Such apparatus is heavy and expensive, and introduces further losses. The motors themselves are admittedly (Lincoln³) heavier and more expensive.

In the case worked out by Lincoln,³ a car equipped with the single-phase system

¹ The motor to which the tests refer was designed by Messrs. Winter and Eichberg. As is well known, this type of motor, which has been developed by Latour in France and by Winter and Eichberg in Germany during the last few years, has brought the single-phase motor nearer to a distinctly commercial stage of practicability for traction and other purposes.

² "Electric Machine Design," Parshall and Hobart, London, *Engineering*, 1906.

³ "Interurban Electric Traction Systems, Alternating *versus* Direct Current." *Electrical World and Engineer*, December 12th, 1903, p. 951.

LOCOMOTIVES AND MOTOR CARRIAGES

weighed 41·3 tons complete, as against 35 tons for the continuous-current equipment. The total weight of electrical apparatus carried, is thus in the single-phase system, well on towards double the weight in the continuous-current system. This is confirmed by Lincoln's figures, which show over 60 per cent. greater cost per (electrical) car equipment. Sixty per cent. greater cost in such apparatus is associated with a considerably higher percentage increase in weight.

The preparation of a rigid quantitative comparison is, in such a case as this, beset with difficulties, but it should be evident from the data set forth, that pending considerable further development, the continuous-current motor has as yet no rival in city and suburban work.

For interurban work, it is believed that the 600-volt continuous-current motor can generally hold its own; nevertheless there appears insufficient reason why advantage should not be taken of the higher economies incident to employing higher voltage at the motor.

Thus in Lincoln's comparison of a 60-mile interurban line, 600 volts is taken for the continuous-current system, and a cost for the secondary network amounting to 30 per cent. of the total cost of the electrical system is deduced. In fact, it is only by comparing a 3,000-volt secondary network for the single-phase system with a 600-volt network for the continuous-current system that an advantage appears to be obtained for the single-phase system.

The following criticisms of Mr. Lincoln's estimate appear sound:—

(1) That he overlooks the fact that single-phase generators cost some 30 per cent. more than polyphase generators for the same rating and guarantees;

(2) That he overlooks the increased cost of low periodicity transformers;

(3) That there is no reason to employ many small and expensive single-phase transformers for the polyphase central and sub-stations: it is only in America that this has been customary, and now large polyphase transformers are being substituted for groups of single-phase transformers in America also;

(4) That the single-phase generating plant is not sufficiently liberally proportioned in view of the poor average power factor;

(5) That, since the chief handicap of the continuous-current system is, as Mr. Lincoln has pointed out, the low tension conducting system, the voltage should have been increased, as this is a perfectly sound proposition in the present state of the art, much more sound than some of the features of the single-phase system he describes;

(6) Large transformers are artificially cooled, and some attendance, such as very frequent patrolling, is advisable for the sub-stations, even with the single-phase system;

(7) The high voltage per turn in the field spools of the alternating current system, the less satisfactory commutation, and the more complex auxiliary apparatus will inevitably result in a higher percentage depreciation than for the continuous-current equipment: nevertheless Mr. Lincoln takes 10 per cent. for the former and 12 per cent. for the latter.

Let us compare Lincoln's 60-mile road, introducing justifiable corrections for his single-phase figures, and substituting for his 600-volt continuous-current system, with sub-stations, a system with two continuous-current generating systems located respectively 15 miles from each end of the system and 30 miles from one another. These stations shall be equipped with slow speed 1,350-volt continuous-current generators, and the cars shall be fed at an average voltage of 1,300. Each car shall

ELECTRIC RAILWAY ENGINEERING

carry two 650-volt motors connected in series and operated as a 1,300-volt unit. The acceleration shall be rheostatic.¹

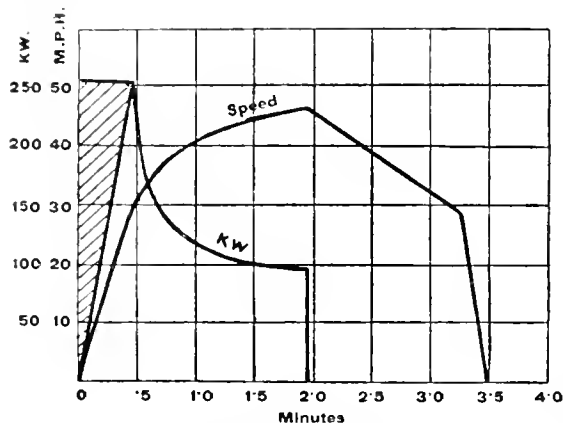

Fig. 395. DIAGRAM FOR CONTINUOUS-CURRENT 2-MILE RUN.

given by Mr. Lincoln for the continuous-current equipment becomes modified, owing to rheostatic control, to that given in Fig. 395, the average input now being 77.5 kilowatts, instead of 67.2 kilowatts, an increase of 15 per cent. due to rheostatic control. In arriving at this figure the weight of car is taken at 36 tons, as against Mr. Lincoln's 35 tons, to cover the increased rheostatic capacity required. Mr. Lincoln's diagram for the single-phase equipment is reproduced in Fig. 396,² and his figure of 73.9 kilowatts average input for the single-phase equipment will be employed, except that to it must be added the losses in the other apparatus on the car, which, from his data, is seen to introduce an increase of 5 per cent.

Hence the average input per car = 77.5 kilowatts for the single-phase equipment.

¹ By merely adding ordinary series-parallel control apparatus to the equipment of such a car it may be run through cities already provided with a 600-volt trolley system, and will give a high efficiency even with the number of stops per mile necessary in such crowded traffic. With the single-phase equipment, on the other hand, such combined service, as pointed out by Lincoln, would lead to further serious complications owing to the essentially different conditions introduced by the very low voltage of the motors.

² From Fig. 396 it is evident that the average power factor during starting is very low, and this leads to such large losses due to the wattless component's I^2R loss in generators, transformers, line, and motors, as to largely off-set any gain through avoidance of the use of rheo-stats in starting.

The 60-mile road is operated on a schedule speed of 30 miles per hour, with 30-second stops every 2 miles. The cars run half an hour apart. The braking is at the rate of 2.0 miles per hour per second (0.89 metres per second per second), and the accelerating is at the rate of 1.0 miles per hour per second (0.45 metres per second per second). The continuous-current car complete weighs 36 tons, and the single-phase car 41.3 tons. The former carries two 150 h.-p. motors, and the latter two 165 h.-p. motors.

The diagram of cyclic operations

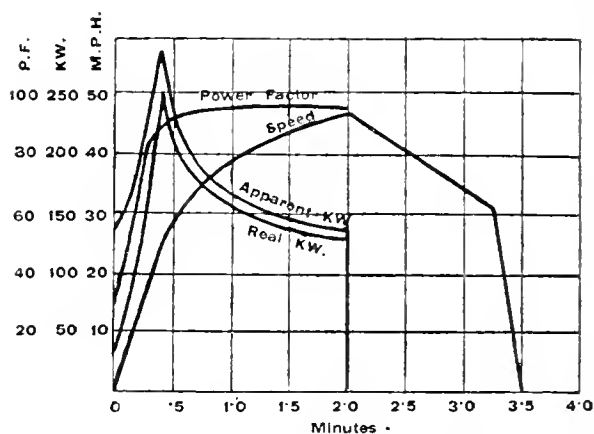

Fig. 396. DIAGRAM FOR SINGLE-PHASE 2-MILE RUN.

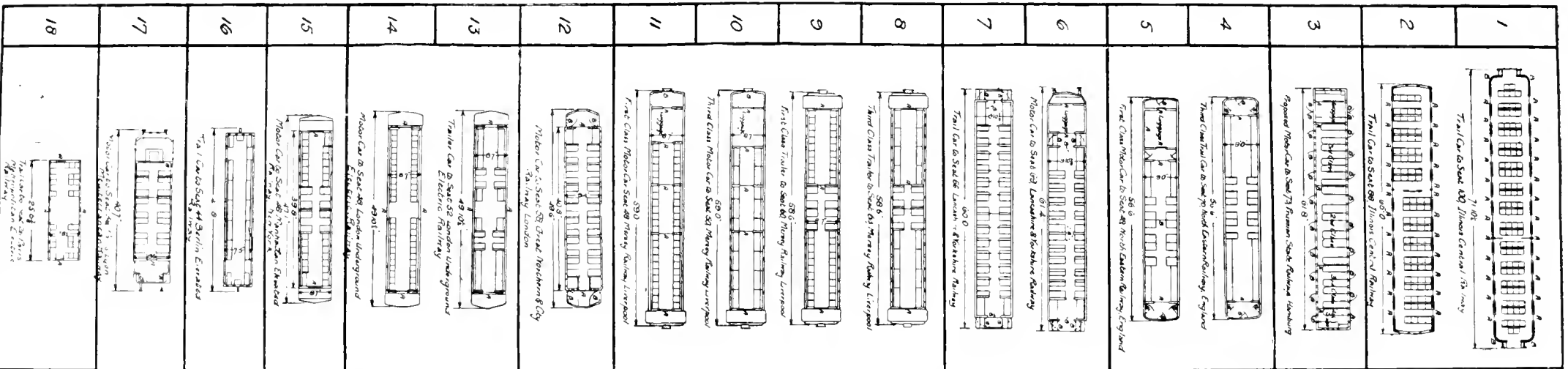
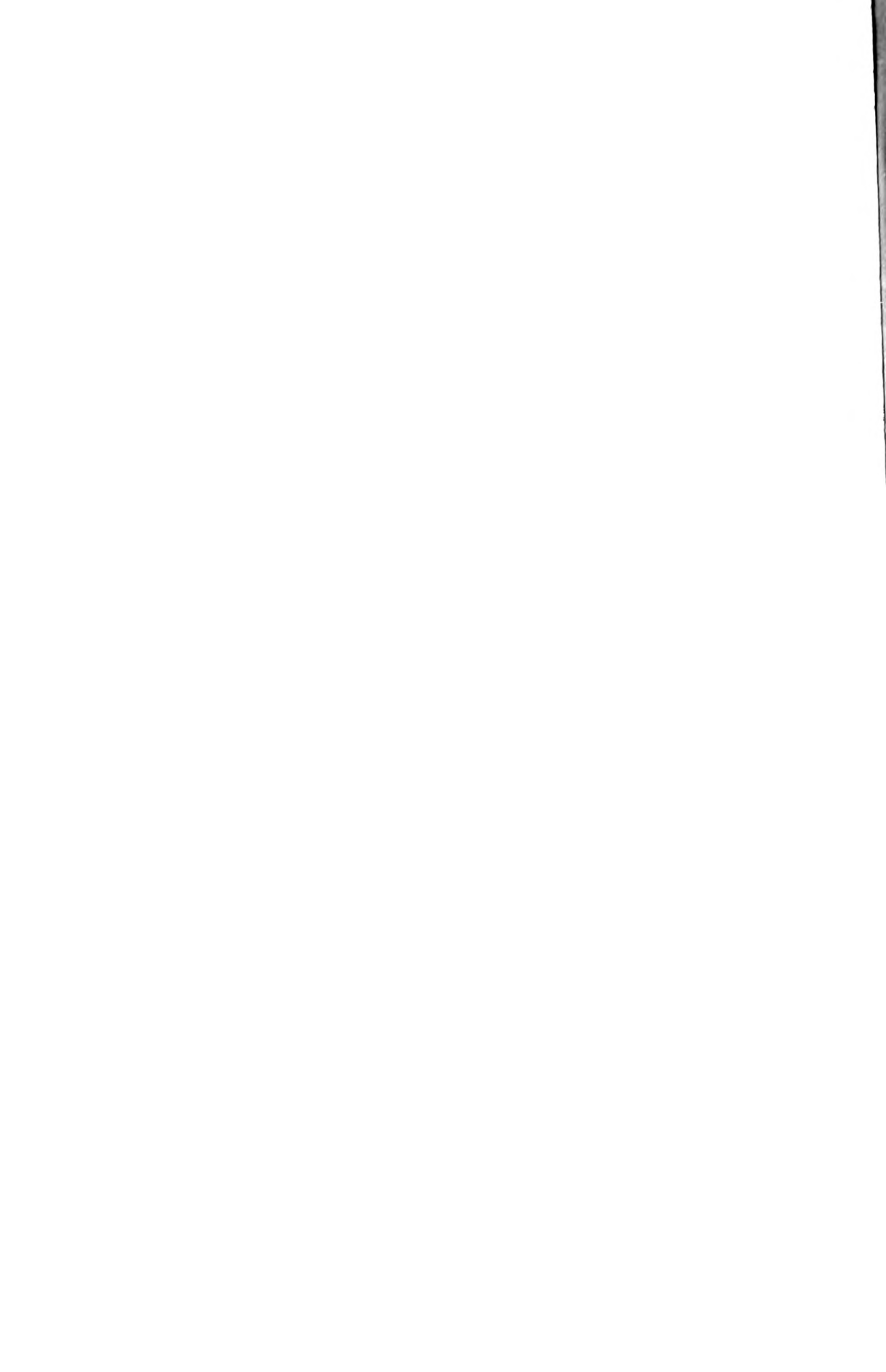

FIG. 316A. PLAN OUTLINES OF MOTOR CARRIAGES AND TRAILERS.

Note — A indicates Sliding Door, B indicates Swing Door



LOCOMOTIVES AND MOTOR CARRIAGES

CONTINUOUS-CURRENT RAILWAY SYSTEM.

Average kw. at car in typical 2-mile run (Fig. 395)	77.5 kw.
Number of cars running at one time	8
Number of stations	2
Average number of cars per station	4
Average volts at car	1,300 volts.
Average current per car	595 amps.
Average current per station	238 amps.
Resistance of 15 miles of 80-lb. track rail and 60-lb. third rail...	1.13 ohms.
Average line loss per station ...	17.0 kw.
Average kw. per station at cars...	310 kw.
Average kw. per station at station	327 kw.
Per cent. loss in third rail	5.2 per cent.
Maximum load per station... ..	800 kw.

SINGLE-PHASE RAILWAY SYSTEM.

Average real kw. at car in typical 2-mile run (Fig. 396)	77.5 kw.
Number of cars running at one time	8
Number of sub-stations	5
Average number of cars per sub-station... ..	1.6
Average apparent kw. per car ...	89.0
Average volts per car	3,000
Average current per car	29.7 amps.
Average current per sub-station... ..	47.5 amps.
With sub-stations 12 miles apart, 80-lb. track rails, and No. 0000 B. and S. trolley wire, the resistance between sub-stations allowing for increased rail resistance	4.20 ohms.
Average real kw. per sub-station at cars... ..	121 kw.
Trolley and rail loss per sub-station... ..	3.3 kw.
Per cent. loss in trolley and rails	2.8 per cent.
Average real kw. per sub-station at sub-station	127 kw.
Per cent. loss in step-down transformers	3.5 per cent.
Per cent. loss in high tension line	2.5 per cent.
Per cent. loss in step-up transformers	3.5 per cent.
Total percentage loss up to secondary distributing system	8.5 per cent.
Average real kw. delivered to secondary distributing system	635 kw.
Average real kw. generated at power-house	690 kw.
Average apparent kw. generated, about	810 kw.
Maximum load at sub-station (two cars starting with, say, 275 apparent kw. each)	550 kw.
(One 350-kw. transformer will take care of this with 57 per cent. overload.)	
Average load on sub-station, about	40 per cent.
(These transformers are sufficiently large to take care of load if one is cut out.)	
Maximum load on power-house in apparent kw., say	1,400 kw.
(Can be taken care of with three 525-kw. generators, one for spare.)	
(Each generator built for guaranteed capacity of 50 per cent. overload for 1 hour.)	
Average real kw. for whole system	690 kw.
Average apparent kw. for whole system... ..	810 kw.

(Each power-house requires three 300-kw. generating sets, of which one is a spare, each generator built for a guaranteed capacity of 50 per cent. overload for 1 hour.)

Average kw. for whole system 654 kw.

ELECTRIC RAILWAY ENGINEERING

STEP-UP TRANSFORMERS.

Three 150-kw. transformers—load can be carried by two in case of emergency.

HIGH TENSION LINE.

One No. 3 B. and S. gauge line each way from power-house
20,000-volt single phase.
Maximum loss, about 8·2 per cent.
Average loss, about 2·7 per cent.

SUB-STATION EQUIPMENT.

Four sub-stations: the power-house feeds directly into 3,000-volt trolley.
Each sub-station to contain one 350-kw. transformer and switch-board.

LOW TENSION DISTRIBUTING SYSTEM.

Entire length of track equipped with 60-lb. conductor rail.	Entire length of track equipped with No. 0000 B. and S. gauge trolley.
---	--

CAR EQUIPMENTS.

Each car equipped with two 150 h.p. continuous-current railway motors and rheostatic control.	Each car equipped with two 165 h.p. alternating current railway motors with multiple control apparatus complete.
---	--

ESTIMATED FIRST COST OF ELECTRICAL EQUIPMENT.

POWER STATION.			
Six 300-kw. 1,350-volt continuous current slow-speed generators, at £1,200 each	£7,200	Three 525-kw. 17-cycle single-phase 3,000-volt generators, at £2,000 each	£6,000
Switchboards	1,000	Three 450-kw. 17-cycle 3,000 to 20,000-volt step-up transformers, at £500	1,500
		Exciting generators	1,000
		Switchboard	760
	£8,200		£9,260

HIGH TENSION LINE.

Forty-eight miles ¹ of 20,000 volts single-phase transmission line, No. 3 B. and S. gauge conductors, at £240 per mile	£11,520
Lightning protection	400
	£11,920

¹ Another high tension line to be maintained as a spare, at a further cost of some £10,000, ought to be provided for the single-phase system, in order to obtain the same immunity from interruption of the service which is provided by the continuous-current system. By the use of two power-houses in the latter system, the third rail may be divided into four independent sections. With the spare high tension line, the advantage for the continuous-current system would thus be considerably greater even than that arrived at in the above estimate.

LOCOMOTIVES AND MOTOR CARRIAGES

SUB-STATIONS.

Four 350-kw. 17-cycle 20,000 to 3,000 volts step-down transformers, at £440 each	£1,760
Five switchboards, at £300 each	1,500
Auxiliary signalling lines for operating sub-station switches	1,500
	£4,760

LOW TENSION DISTRIBUTION SYSTEM.

Sixty-three miles of 60-lb. conducting rail, at £500 per mile installed	£31,500	Sixty-three miles, No. 0000 trolley wire in place, at £180 per mile	£11,340
Bonding main track—63 miles, at £80 per mile... ..	5,040	Bonding main track, 63 miles, at £80 per mile... ..	5,040
		Fifteen miles of pole construction, not including horse-power lines, at £126 per mile	1,890
	£36,540		£18,270

CAR EQUIPMENTS.

Twelve continuous-current car equipments complete, consisting of motors with rheostatic control, heaters, and contact shoes, at £1,100 each	£13,200	Twelve alternating current car equipments complete, consisting of two 165 h.-p. motors with multiple control outfit, heaters, and trolley, at £1,700	£20,400
--	---------	---	---------

TOTAL FIRST COST OF ELECTRICAL EQUIPMENT.

£57,940		£61,610
---------	--	---------

ESTIMATE OF YEARLY OPERATING EXPENSES.

<i>Continuous Current System.</i>		<i>Alternating Current System.</i>	
Eight men at power-houses, two shifts, average wage £180 per year	£2,880	Five men at power-house, two shifts, average wage £180 per year each	£1,800
Fuel, water, oil, etc., at 0.30 <i>l.</i> per kw.-hour, 4,250,000 kw.-hours	5,300	Two patrol men, two shifts, average wage £180 per year	720
Repairs and maintenance of power-house, electrical equipment (4 per cent. of cost per year)	328	Fuel, water, oil, etc., at 0.25 <i>d.</i> per kw.-hour... ..	4,600
Repairs and maintenance of third rail (1 per cent. of cost per year)	365	Repairs and maintenance of power-house, electrical equipment (3 per cent. of cost)	278
Repairs and maintenance of car equipments (12 per cent. of cost per year)	1,500	Repairs and maintenance of high-tension line (5 per cent. per year)	596
		Repairs and maintenance of trolley (4 per cent. per year)	730
		Repairs and maintenance of car equipment (12 per cent.)	2,140
	£10,373		£11,164
Total yearly operating expenses	£10,373	Total yearly operating expenses	£11,164

The increased outlay incurred by the use of two power-houses with the consequent slightly increased cost of steam plant is largely offset by the saving obtained through dispensing with sub-station buildings. In this connection it may be mentioned that Mr. Lincoln makes no allowance for depreciation of sub-station plant, and this has not been introduced in the present estimate.

ELECTRIC RAILWAY ENGINEERING

The result shows the single-phase system to be 12 per cent. higher in first cost, and 7 per cent. higher in operating expenses for the items taken into consideration.

Two power-houses were taken for the continuous-current proposal, as this arrangement is fairly suitable for the line assumed by Mr. Lincoln for his purposes and for 1,350 volts at the generators. No especial significance is, however, to be attached to such choice. For extensive lines, polyphase generation from a single station would often be preferable. Moreover, considerably higher continuous-current voltage at the generators and motors could have conservatively been proposed with further resulting economies, not the least of which would have been the employment of a single power-house with continuous-current generators for such a case as Mr. Lincoln's 60-mile line. This would have led to lower generating costs, less spare sets, fewer and larger units, and a better load factor.

It is believed that these arguments and comparisons afford ground for the opinion that the superiority of the single-phase motor for other than main line work is as yet by no means a foregone conclusion. Nevertheless the single-phase commutator motor represents a very important advance. It is beyond all comparison superior to the commutatorless single-phase motor, and is already not greatly inferior to polyphase motors and continuous-current motors. This is an excellent record for such a brief developmental period.

The cost of the 1,350-volt continuous-current system used in the present estimate, and that of the 600-volt continuous-current system on which Mr. Lincoln estimated, are respectively—

	1,300 volts.	600 volts.
Total first cost of electrical equipment	£57,900	£75,500
Total yearly operating expenses for power and for maintenance of electrical plant	£10,400	£11,100

This shows for the former system an advantage of 30 per cent. in first cost of electrical equipment, and of 7 per cent. in total yearly operating expenses for power and for maintenance of electrical plant.

In concluding this chapter we have brought together in Fig. 396A, arranged in order of decreasing lengths, examples of eighteen motor carriages used on various railways. This has been compiled from the material published by Dawson.¹ In Table CXX. we have arranged in tabular form considerable data of interest, which we have calculated from the plan outlines of Fig. 396A.

¹ *Street Railway Journal*, Vol. XXVII., No. 14 (April 7th, 1906).

LOCOMOTIVES AND MOTOR CARRIAGES

TABLE CXX.

Showing the Seating Capacity per Square Foot of Coaches used on Various Railways.

Reference Number corresponding to Fig.	Railway.	Type of Car.	Total Number of Seats.	Overall Length.	Overall Breadth (i. e., to Outer Wall of Body).	Seats per Square Foot.	Seats per Foot.
1	Illinois Central Railway	Trailer Car	100	71·85	10·6	0·131	1·40
2		Trailer Car	88	65·0	10·6	0·128	1·35
3	Prussian State Railways	Proposed Motor Car	73	61·66	8·5	0·14	1·18
4	North Eastern Railway	3rd Class Trailer Car	70	56·5	9·0	0·138	1·24
5		1st Class Motor Car	48	56·5	9·0	0·095	0·85
6	Lancashire and Yorkshire Railway	Motor Car	69	61·3	9·86	0·114	1·13
7		Trailer Car	66	60·0	9·86	0·111	1·10
8	Mersey Railway, Liverpool	3rd Class Trailer	64	58·5	8·58	0·127	1·09
9		1st Class Trailer	60	58·5	8·58	0·12	1·02
10		3rd Class Motor Car	50	59·0	8·58	0·099	0·85
11	Great Northern and City Railway	1st Class Motor Car	48	59·0	8·58	0·095	0·81
12		Motor Car	58	49·5	9·33	0·125	1·17
13	London Underground Electric Railway	Trailer	52	50·29	8·58	0·120	1·03
14		Motor Car	48	50·29	8·58	0·111	0·95
15	Manhattan Elevated Railway	Motor Car	48	47·08	8·58	0·119	1·02
16	Berlin Elevated Railway	Trailer	44	41·66	7·42	0·142	1·06
17	Paris-Lyons Mediterranean Railway	Motor Car	36	40·58	9·42	0·092	0·89
18	Paris Metropolitan Electric Railway	Trailer	26	25·57	7·71	0·132	1·02

Chapter X

TRUCKS

TRUCKS are either for a rigid wheel base or for bogie stock. In railway practice proper, the use of rigid wheel bases may be considered as limited to locomotives. since, so far as the authors are aware, there is only one electric railway, the Paris Metropolitan, employing motor cars with rigid wheel bases (see Figs. 397 and 398), and

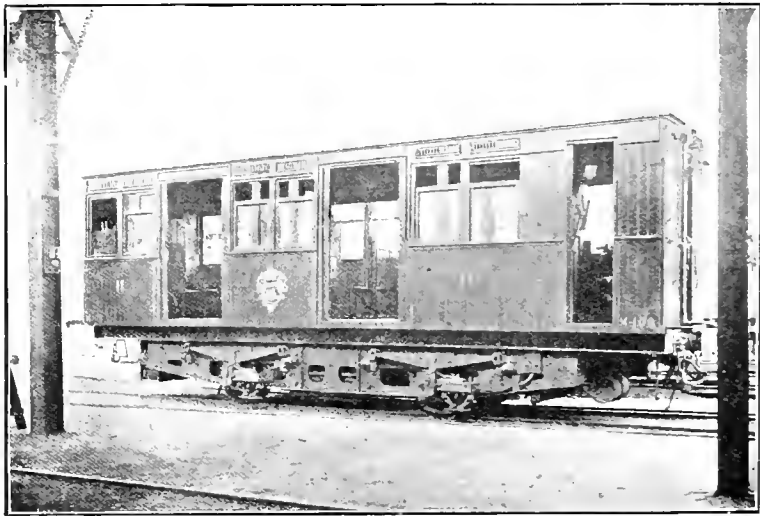

Fig. 397. PARIS-METROPOLITAN MOTOR CAR WITH RIGID WHEEL BASE.

these are now being abandoned. From the point of view of truck design, however, it is more or less a matter of detail whether the truck is to form part of the under-frame of the vehicle itself, as in the case of rigid wheel base stock, or to be merely attached to it, as in the case of bogie stock. In either case the truck should be regarded as in all respects the equivalent of an electric locomotive so far as relates to general design, material, and workmanship, and there is no good reason for relaxing the rigorous standards which experience has shown to be necessary in locomotive work. We mention this because there is a certain school of engineers and manufacturers who appear to regard truck building as an art so distinct from any other branch of mechanical engineering, that rough workmanship and inferior material may be

TRUCKS

employed without corresponding disadvantages. The authors not only find no justification for this view, but they have found that in truck work, even more than in the case of most kinds of machinery, undue reduction of capital cost leads to utterly disproportionate increase in maintenance cost. The writers would further contend that if the use of inferior material and workmanship is unjustifiable on stationary plant, where a breakdown usually means mere inconvenience and expense, it is nothing short of criminal in the case of rolling stock, where a breakdown is so very likely to involve injury to life and limb.

The frames employed on the first electric locomotives of any size—those of the City and South London Railway—follow the lines of English steam locomotive practice in that they are built of steel plate riveted up, and with semi-elliptic springs over the axle-boxes. Each frame is mounted on four wheels, and carries two motors, the armatures being mounted direct on the axles. This type of frame has been followed

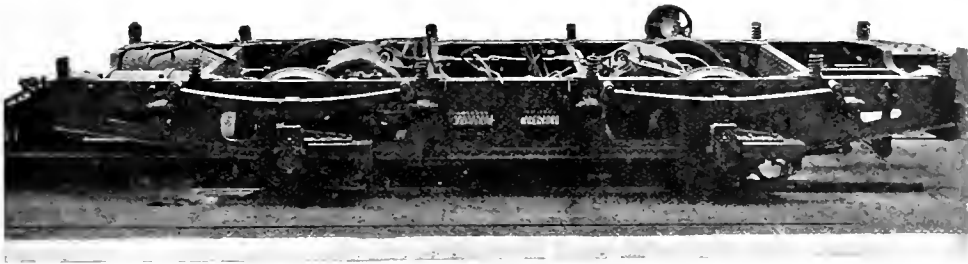

Fig. 398. TRUCK OF PARIS-METROPOLITAN MOTOR CAR WITH RIGID WHEEL BASE.

with practically no alteration for all the locomotives on this line. The construction will be understood from the photograph of Fig. 275, on p. 316.

The first large electric locomotives in the United States—those of the Baltimore and Ohio Railway—follow the locomotive practice of that country, the truck being built up of wrought iron bars welded together to form a trussed frame. Each frame rests on four wheels, and carries two gearless motors. Two of these four-wheel trucks, coupled together, form the under-frame of the locomotive. One-half of the cab, together with a sloping end, of the type that has been so widely employed for electric locomotives, is carried by each truck. This locomotive has been illustrated in Fig. 268, on p. 308. The newer electric locomotives of the Baltimore and Ohio Railway (see Figs. 269 to 272, on pp. 310 to 313) also have rigid wheel bases, but the frames, which are carried on four axles, are equipped with four geared motors. In consequence of the decreased weight of the motor, it became necessary in this later type, to increase the weight of the frames in order to secure sufficient adhesion. The frames are therefore constructed of cast steel, the side and end members being machine-fitted and bolted together. The frame rests on four inverted semi-elliptic springs, the

ELECTRIC RAILWAY ENGINEERING

ends of the springs resting on the axle-box tops. The locomotive weighs 73 metric tons, and in service two of them are usually coupled together.

The locomotives now being manufactured for the New York Central Railway are of the design already shown in Figs. 252 to 254, on pp. 291 to 294. They have gearless motors, and, the necessity for added weight in the frames thus being obviated, a bar frame of the American steam locomotive type has been adopted. The locomotive has six axles, of which four—the driving axles—carry the frame direct and two through pony trucks, that is, two-wheeled swivelling trucks.

The frame is supported through equalising levers on semi-elliptical springs. The equalising lever is practically universal in American locomotive practice, but has been comparatively little adopted in this country. Its object, briefly stated, is to enable short and therefore cheap and compact springs to do the work of longer ones. Any

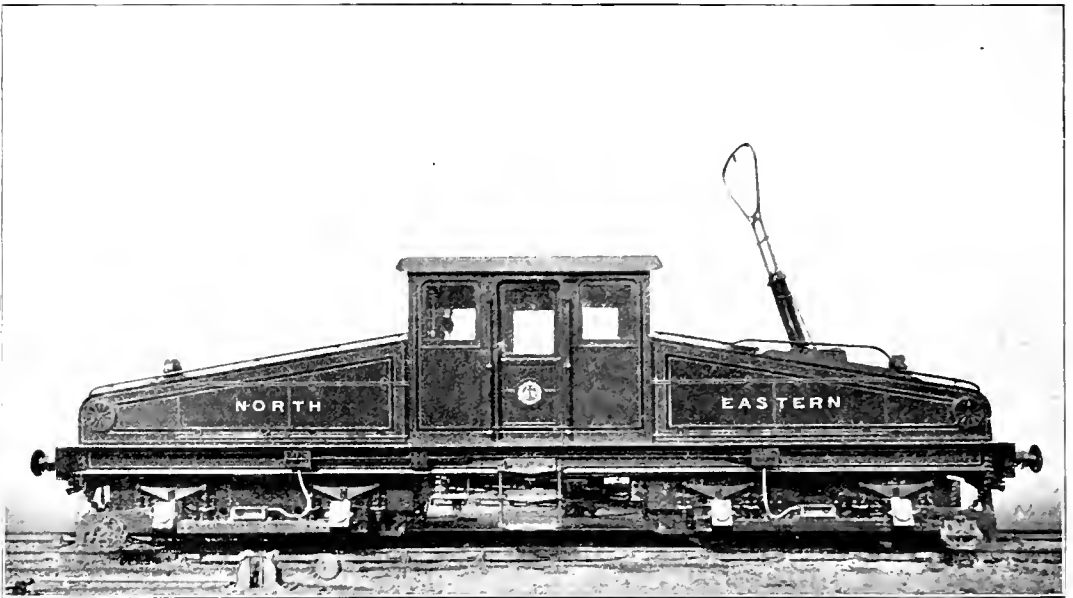

Fig. 399. Goods LOCOMOTIVE OF NORTH-EASTERN RAILWAY.

upward movement of the axle relative to the frame will be taken up partly by compressing the spring over the axle, partly by raising the frame through the lever fulcrum, and partly by compressing the next spring on either side, thus reducing the travel of the frame for a given travel of the axle-box.¹ The same effect could obviously be obtained by the use of more flexible springs, and this is the usual European practice, the springs being made longer and in consequence deeper.

The question of the most suitable material for locomotive frames must depend somewhat on whether geared or gearless motors are employed. Where gearless motors are used there is no doubt that steel plate or rolled steel sections form

¹ In some steam locomotives an additional use is made of the equalisers, means being provided permitting the driver to alter the distribution of the load on the various axles so as to increase the adhesion when starting.

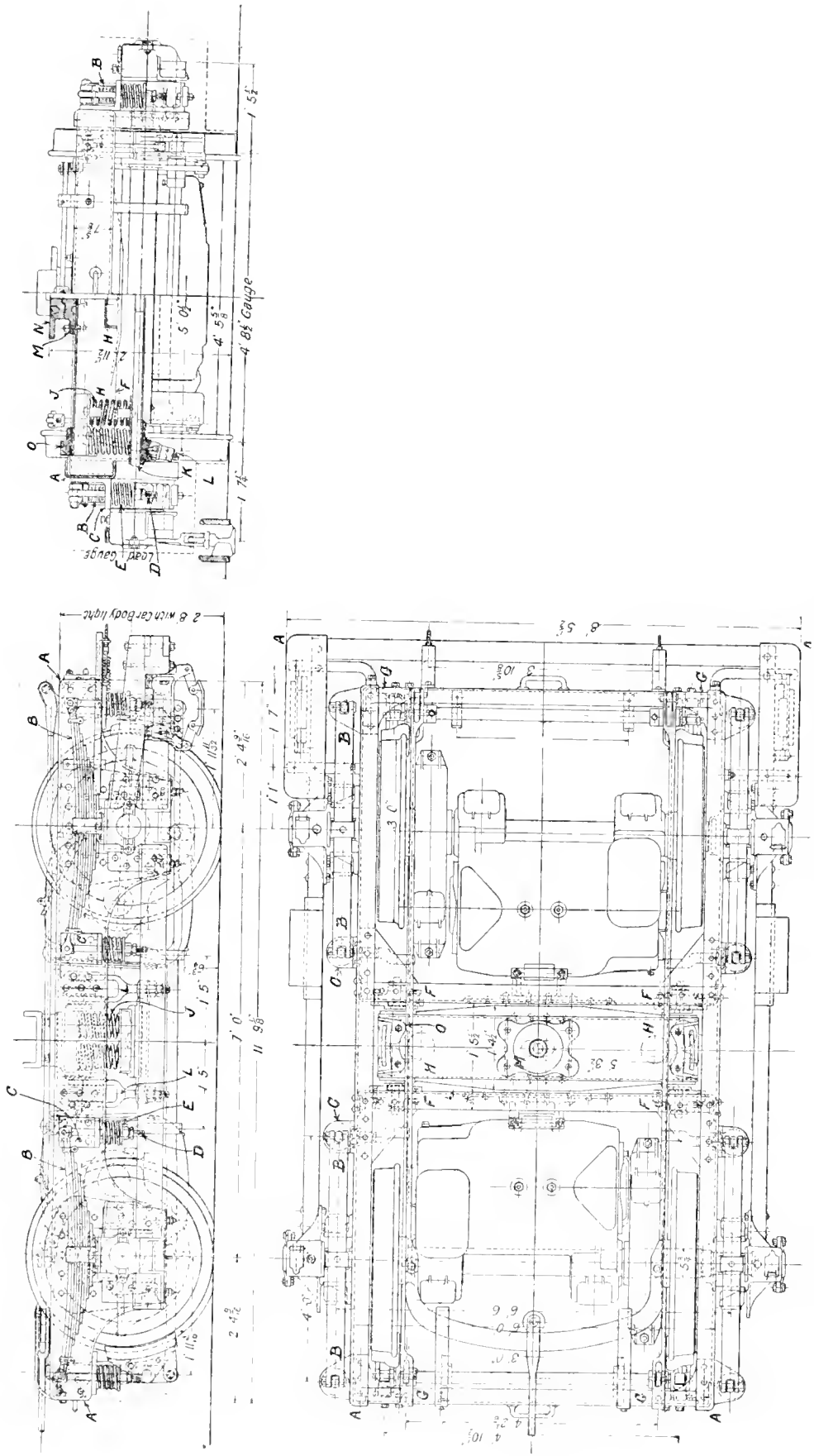

FIG. 400. MR. WORSDELL'S DESIGN FOR THE BOGIES FOR THE ELECTRIC MOTOR CARS FOR THE NORTH-EASTERN RAILWAY. (GENERAL ARRANGEMENT OF MOTOR TRUCK (BRUSH ELECTRICAL ENGINEERING CO., LTD.))



TRUCKS

the most suitable material, but if this construction be employed with geared motors, it will often be necessary to ballast the locomotive in order to obtain sufficient adhesion. This has been done in several cases, one important instance in this country being the goods locomotives of the North-Eastern Railway. One of these locomotives is illustrated in Fig. 399. The under-frame is of rolled steel sections, and is ballasted with cast iron blocks. Strictly speaking, the under-frame does not come within the scope of this chapter, since it is not a truck frame, but is itself mounted on two bogie trucks.

In the great majority of cases arising in electric traction engineering, the motors are mounted on bogie trucks under coaches carrying passengers.

With regard to the design of such bogies, the strains they have to carry are similar in character to those of trailer bogies, though they are usually greater in intensity, more frequently applied, and more irregular. Consequently it would appear that any design generally suitable for a trailer bogie should be suitable for motor driving, if due attention is paid to securing the necessary additional strength. The type of bogie which is generally used in this country on steam railways, so generally,

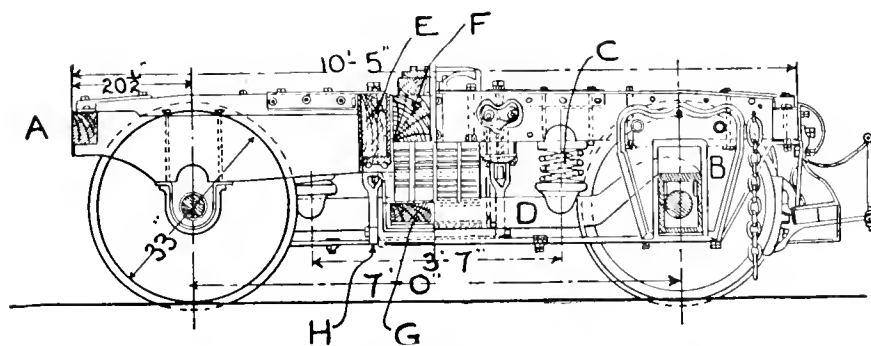

Fig. 401. TYPE OF BOGIE TRUCK AS EMPLOYED FOR PASSENGER COACHES ON AMERICAN STEAM RAILWAYS.

in fact, as to be practically universal, may be described by reference to Fig. 400. It has a frame A of rolled or pressed steel, carried on semi-elliptical springs B, of which there is one over each axle-box. The semi-elliptical springs B support the frame at lugs C by means of screwed hangers and nuts D. Rubber cushions or short helical springs E are usually placed between the nuts and the lugs.¹ The axle guards are in one piece with the side frame, if this is of pressed steel, otherwise they are of steel plate riveted to the frame, as in the case of the bogie shown in Fig. 402 (facing p. 434). The transom F (Fig. 400) and the end members are of rolled or pressed steel, riveted to the side frames. The bolster H is of pressed steel, or of timber reinforced by steel, and is carried by helical springs J on a swing bolster K, hung by links L from the transom. This bogie, with various modifications, is in use on almost all steam railways in this country. Owing, however, to the influence of American practice on electric railway engineering, the American type of bogie has been much more generally employed for rolling stock equipped with electric motors. The American type of bogie, of which an example is shown in Fig. 401, is used, with slight modifications,

¹ The latest bogies on the Great Western Railway have helical axle-box springs.

ELECTRIC RAILWAY ENGINEERING

for practically all passenger cars on American steam railways. On steam railway cars it consists of a timber frame A with cast iron or steel axle guards B—or pedestals, as they are called in America—supported by helical springs C on wrought-iron equaliser bars D, which in turn rest on the axle-boxes. The transom E and bolster F are usually of timber, the bolster resting on elliptical springs carried by a spring plank G, which is suspended by swing hangers H from the transom, the hangers being inclined inwards at the top, so that when the car swings outwards in passing round curves the inner side of the body is lowered and the outer raised. The swing bolster has been in practically universal use, being the standard construction adopted in 1884 by the Master Car-builders' Association. Subsequent to that date, however, the majority of car-builders have come round to the conclusion that a rigid bolster is preferable, apart from its lower first cost and maintenance.

It is not purposed to discuss the relative merits of the European and American types of bogie. Rolling stock superintendents of steam railways in this country, however, nearly all of whom have employed both types, are practically unanimous in preferring the European type (see Fig. 400), and state that they are much more satisfactory in service than the American type, whether built in America or in this country. On the other hand, the authors can find no record of the European type having been employed for passenger cars in America, although pressed steel trucks (with helical springs throughout, however) are largely used for the heavier classes of freight cars. It is probable that the type of frame found most satisfactory on each continent is largely the result of circumstances. The equalised truck undoubtedly gives slightly smoother running on an inferior road, and may be regarded as having been developed to meet this condition, since bogie stock came into universal use in America many years before it was at all largely used in Europe. On the other hand, on a good road there is practically nothing to choose between the two types. The object of equalising a bogie is, as in the case of the locomotive frame, simply to make a stiff and therefore compact and cheap spring do the work of a more flexible and expensive type. Any upward travel of one axle is taken partly by the nearest, and partly by the furthest, spring, this causing less shock to the frame than if one spring carried it all. The equivalent of this part of the equalising effect could obviously be obtained merely by the use of more flexible helical springs, but it would be difficult to find room for them. A further effect of equalising is to increase the periodic time of swing of the frame when vertical oscillations are set up, owing to the shortness of the spring base. To obtain the same effect with a spring base equal to the wheel base the springs would have to be twice as flexible whilst having the same strength. This effect is obtained in this country by the use of comparatively long and flexible elliptical springs.

The built-up bogie of either rolled or pressed steel with elliptical springs is so near an approach to the standard locomotive frame in this country, is so largely used, and is found to be so generally satisfactory, that it is almost certain to be adopted for motor bogies by the majority of those of the railway companies electrifying their lines in the course of the next few years.¹ In fact, the North-Eastern Railway, which has

¹ The following is a detailed description of this particular design: "The bogies are constructed of Fox's pressed steel plates, having four wheels with a 7-foot wheel base. The sole-bars are $10\frac{1}{2} \times 3\frac{1}{2} \times \frac{1}{2}$ ins. thick at centre, and $8\frac{1}{2} \times 3\frac{1}{2} \times \frac{1}{2}$ ins. thick at ends. The cross-bearers are $8\frac{1}{2} \times 3\frac{1}{2} \times \frac{7}{16}$ ins. thick at centre, the bottom flange being sheared from $3\frac{1}{2}$ ins. in the centre to 3 ins. at the ends. A stiffening plate is also riveted to the web at the centre. The headstocks are $7\frac{1}{2} \times 3 \times \frac{1}{8}$ ins. thick. The top bolster is 9 ins. \times 1 ft. $4\frac{1}{2}$ ins. \times $\frac{3}{8}$ ins. thick at centre. The bottom bolster measures 2 ins. \times 1 ft. $0\frac{1}{2}$ ins., and is made of oak stiffened by two steel angles.

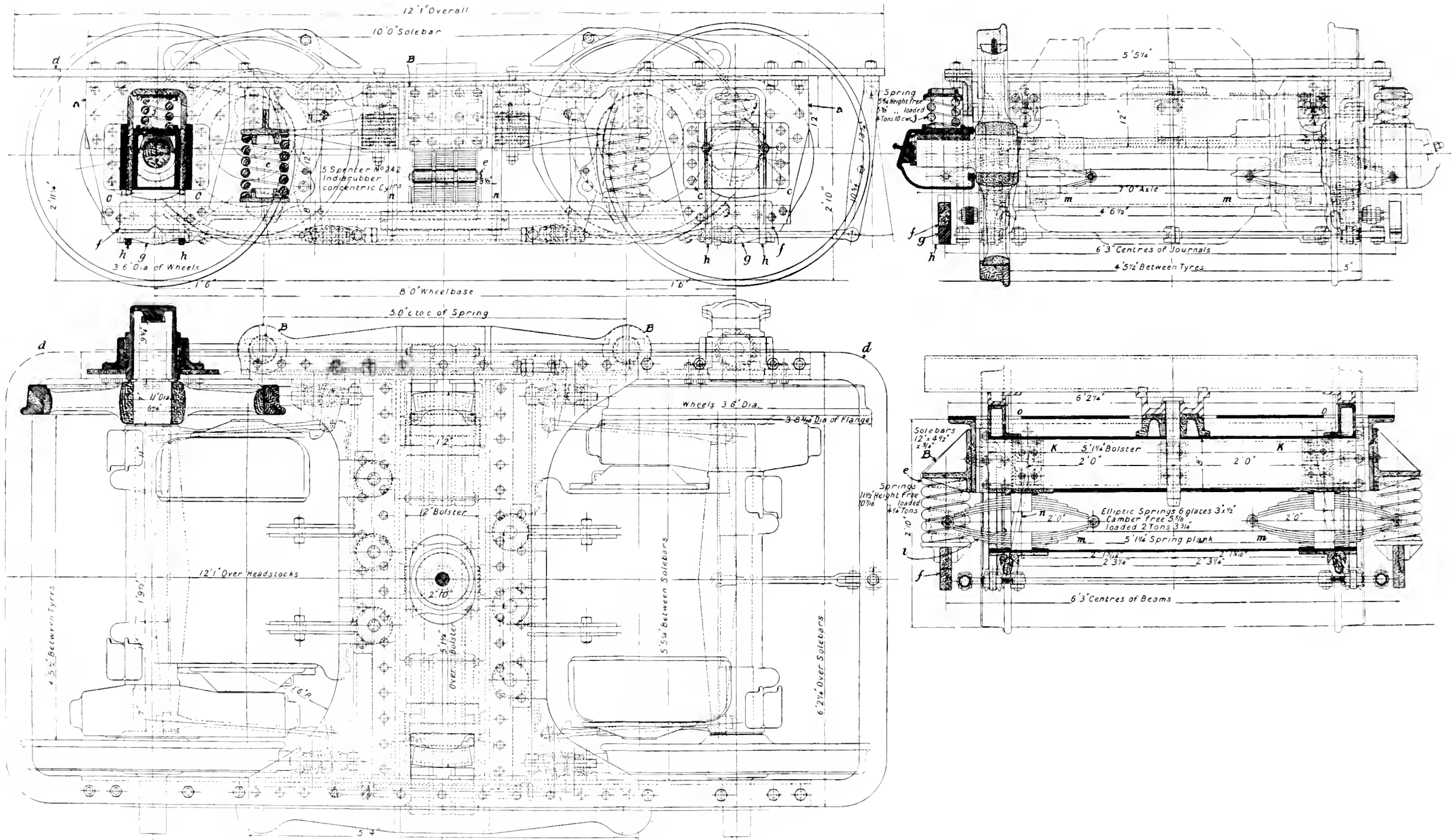

Fig. 402. GENERAL ARRANGEMENT OF MOTOR BOGIE IN HAY'S DESIGN FOR THE BOGIES FOR THE ELECTRIC MOTOR CARRIAGES OF THE LANCASHIRE AND YORKSHIRE RAILWAY.



TRUCKS

in hand one of the largest schemes of this character, has standardised a bogie of this type for the purpose. This bogie, which has already been described and illustrated (Fig. 400), was designed by Mr. Wilson Worsdell, the locomotive superintendent of the line.

The bogie adopted by the Lancashire and Yorkshire Railway, however, is more or less a compromise between the two types. This bogie was designed by Mr. H. A. Hay, M.Inst.C.E., and is illustrated in Fig. 402. The side frames *a* are of deep section angle steel, with cast steel stiffeners *B* and steel plate axle guards *C* riveted to them. The end cross members *d* are of flat steel bar. The frame is supported by four helical springs *e* resting on the equalisers *f*. The equalisers are straight, and, instead of resting on the axle-box tops, are supported on knife edges on short stretcher pieces *g*. Each stretcher piece rests in a bridle *h*, which embraces the axle-box and is supported on a stiff helical spring *J* on the top of the box. The bolster *K* is supported by elliptical springs *I* from the swing bolster *m*, which is suspended by links *n* from the transom *o*. There are thus three sets of springs in series between the wheels and the body of the coach. In this respect the bogie somewhat resembles the Brill bogie, which will be described later on.

The transom construction in Mr. Hay's design should be particularly noted; a single plate is used to do the work of the top plate and gusset plates.

It will be noticed that both these bogies (Figs. 400 and 402) have the axle guards reinforced by machined steel castings so as to increase the bearing surface of the axle-boxes against the jaws. This is usually unnecessary on trailer bogies, but is frequently adopted for tender bogies. For motor bogies with axle guards of this type, it is indispensable, for although the maximum pressure against the axle guards is no greater than on a trailer bogie carrying the same weight, the maximum in either case being that due to the thrust when braking, the thrust due to the motor is applied for much longer periods than the brakes, and the axle guards will wear very rapidly unless thus reinforced.

In the American equalised bogie as adapted for motors, timber is replaced by rolled steel, the frame being usually of flat bar section with the sides and ends in one piece and the axle guards of malleable iron or cast steel. There are usually four

$2 \times 2\frac{1}{2} \times \frac{3}{8}$ ins., as shown on the drawing. The centre casting is steel, and the side bearings cast iron. A special type of cast-steel axle guide is used, having a bearing surface on the axle-box of $63\frac{3}{4}$ sq. ins. to compensate for the great pressure which comes on it due to the thrust of the motor gearing, and to distribute this pressure uniformly over the journal. The axle-boxes are made of cast steel with gunmetal bearings $7\frac{1}{2} \times 4\frac{9}{16}$ ins. wide. A pad lubrication with two spiral springs is used. The front portion of the axle-box has wings cast on to support the collector shoe beams. The side bearing springs are 4 ft. long, and consist of ten plates, two $3\frac{1}{2} \times \frac{5}{8}$ ins., eight $3\frac{1}{2} \times \frac{1}{2}$ ins. The ends are fitted with adjustable hangers and Timmis auxiliary springs, 5 ins. outside diameter and $2\frac{1}{4}$ ins. internal diameter. The bolster springs are composed of two three-coil nests of Timmis unequally loaded springs. A teak packing-block, $2\frac{3}{4} \times 12 \times 12\frac{1}{2}$ ins., is fixed between the bolster and the spring-guides plate. The bogies are carried on disc wheels 3 ft. diameter on tread, keyed upon the axle. The tyres are $5\frac{1}{4}$ ins. wide, and fastened to the wheel centres by retaining rings and eight-set screws per wheel. The axles are—6 ft. 6 ins. centres of journals, $8 \times 4\frac{1}{4}$ ins. journals, $5\frac{3}{4}$ ins. diameter at wheel and spur-wheel seats. The remaining portion of axle between wheel seats, including motor bearings, is $5\frac{1}{4}$ ins. diameter. Each bogie is fitted with two G.E. No. 66 motors, suspended by two bearings on the axle and a cast-steel bracket riveted on to the cross-bearer. The wheels are braked on one side only. The main pull-rod from the Westinghouse horizontal brake levers engages with a yoke of the usual type used on train-cars, and from the ends of this yoke pull rods lead alongside the ends of the motors to vertical levers pivoted on a cross-shaft at the ends of the bogie upon which the blocks are fixed. The weight of the bogie complete is 8 tons 15 cwt."

TRUCKS

equaliser bars, one each side of the axle guards on each side. The transom is usually of rolled channel steel, and the spring plank and bolster of suitable rolled or pressed

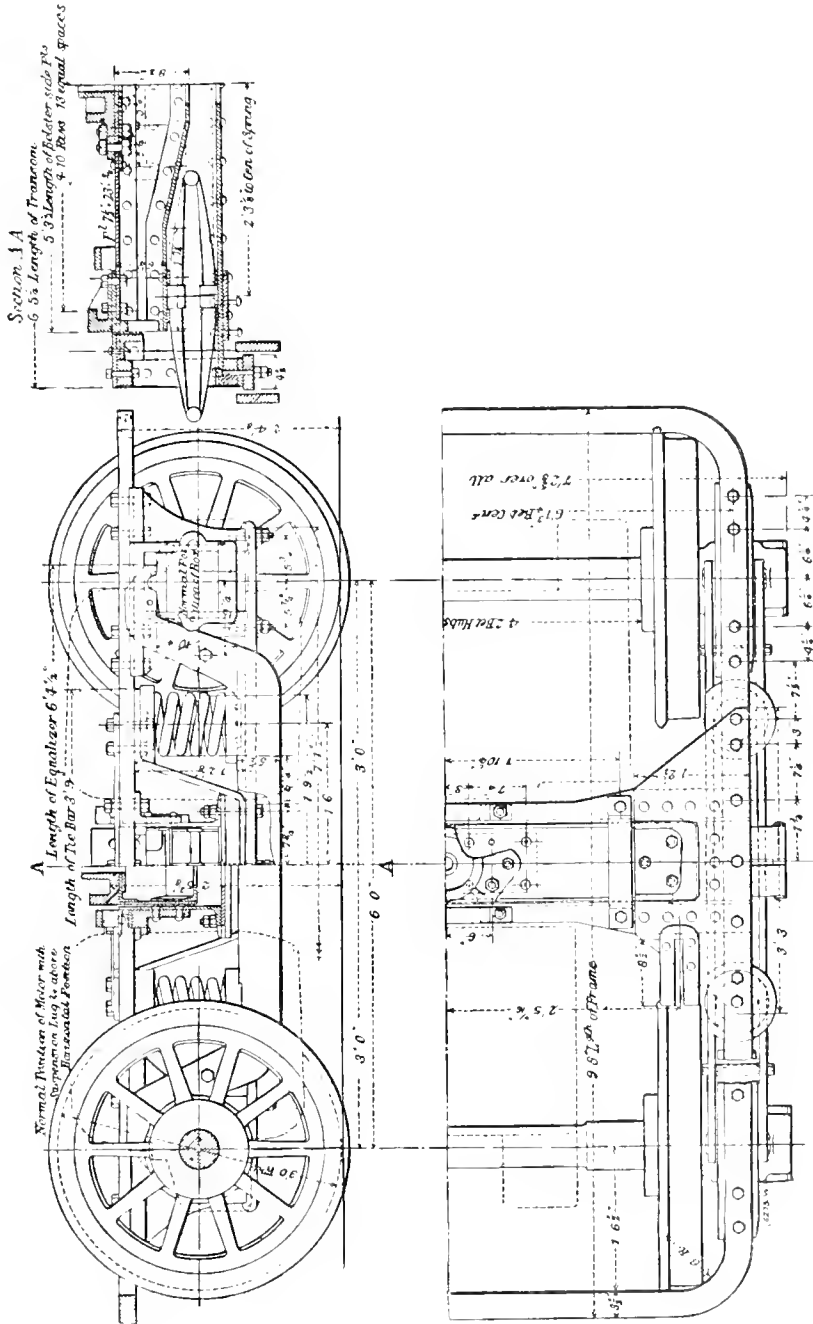

Fig. 404. TRUCK FOR CENTRAL LONDON RAILWAY GEARED LOCOMOTIVE.

steel sections. The transom is usually attached to the side frames by gusset plates at the top, and by braces of flat bar at the bottom. The motor truck used on the Manhattan Elevated Railway, and shown in Fig. 403, is a typical example of this

ELECTRIC RAILWAY ENGINEERING

form of truck, except that it has a frame of angle section instead of flat bar. Another very good example is shown in Fig. 404, illustrating the bogies adopted for some of

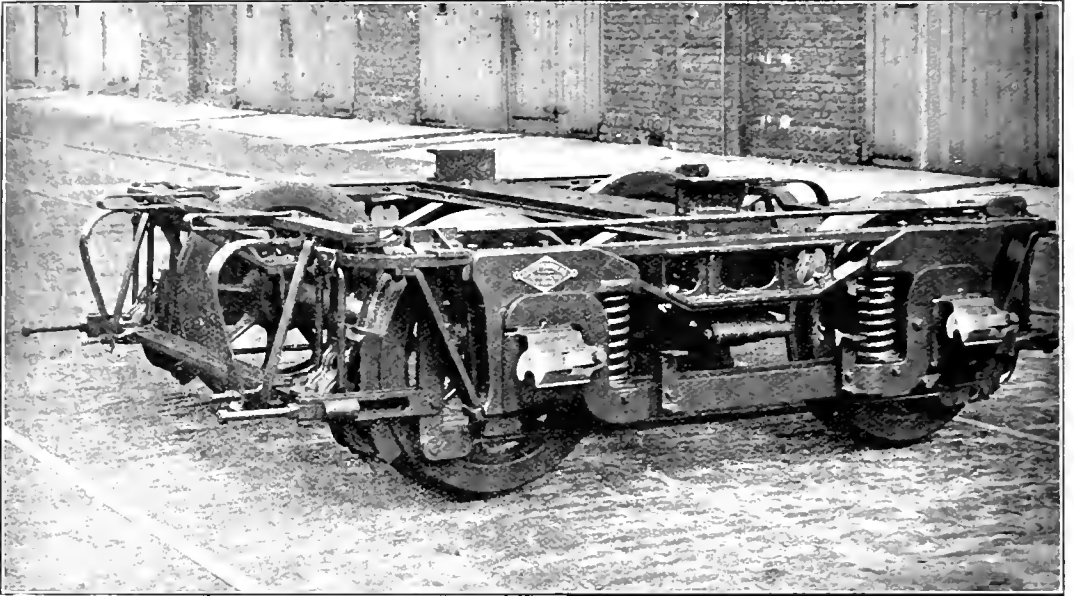

Fig. 405. DISTRICT RAILWAY TRAILER TRUCK.

the later Central London locomotives, which were provided with geared motors, instead of the original gearless machines. This bogie, however, has not a swing bolster, as the clearance between the train and the tunnel is too small to permit of its use.

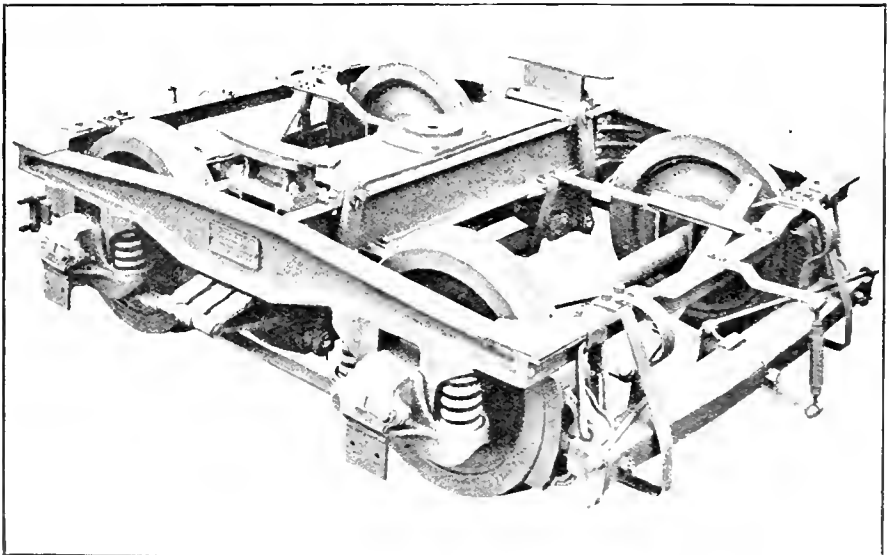

Fig. 406. DISTRICT RAILWAY TRAILER TRUCK.

TRUCKS

A further example of this type is the trailer bogie adopted for the District Railway. This is shown in Fig. 405. The arrangement of axle guards and spring pockets in one casting is novel and distinctly good. The steel casting by which the frame, transom, and braces are connected together is also novel, and ensures a very strong construction. Another type of trailer truck for this road is shown in Fig. 406, and the motor car truck in Fig. 407. The following description of these two trucks, illustrated in Figs. 406 and 407, is taken from an article by E. E. Cook entitled "Electric Traction Trucks," and published in *Traction and Transmission* for October, 1904 (Vol. X., p. 353):—

"They are both made mainly of cast steel, with wrought-iron bolsters and bolster housings. The motor truck weighs, without motors or gear wheels, approximately 10,000 lbs. It is carefully machined in all of its important members; the wheels are invariably steel-tyred. The axles are all hollow, having had their neutral axis removed. The trucks are made to carry two motors of about 150 h.-p. each, with six motors to the train of seven cars. A maximum speed of about 60 miles an hour can be attained. The brakes are designed for air-braking, and have to

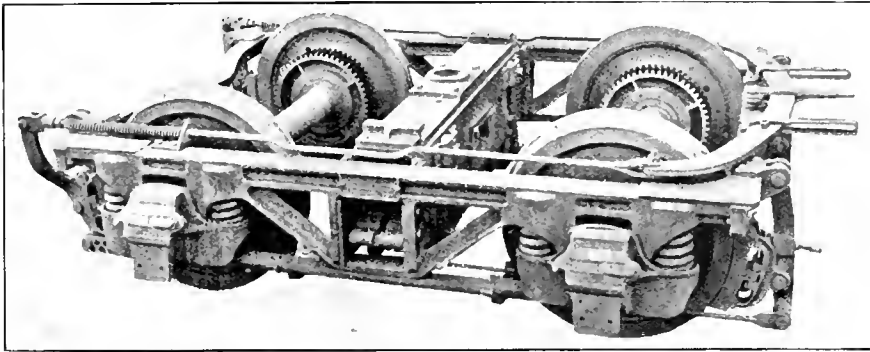

Fig. 407. DISTRICT RAILWAY MOTOR CAR TRUCK.

be much stronger than if used for the ordinary trail truck, for the reasons that there is not only an exceedingly heavier load to stop, but there is the momentum of the armatures to overcome as well; in fact, the pressure on each brake shoe is at least 100 per cent. greater than in trail trucks.

"The advantages of the use of cast steel are best exemplified in this type of truck. The design of the side frame shows a very strong heavy trussing, the depth of which can be varied to suit the strength required, and if these castings are properly annealed there is absolutely no shrinkage strain left in them, so that in this design it is possible to get the maximum strength with the minimum weight."

Fig. 108 shows the latest type of motor bogie designed by Mr. Parshall for the Central London Railway. This combines some of the features of both the steam railway car bogie and the electric motor bogie. The frame *a* is of flat wrought iron bar; the axle guards *b* are double, and are of steel plate, pressed into U shape and coming down each side of the top frame. There is only a single equaliser bar *c* at each side, passing between the two side plates of each axle guard. The space between the inner and outer plates of each axle guard is filled in with pressed steel distance pieces, *d*, of channel section, cut away on one side to admit the equaliser bar. The axle

ELECTRIC RAILWAY ENGINEERING

guard keeps, *c*, are also of pressed steel of channel section and arranged so that the box can be removed by removing a single bolt and dropping the end of the keep. The front and rear axle guards are joined by a channel tie bar, *f*. The transom *g*, is secured to the side frames by gusset plates *h*, flat bar braces *i*, and a pressed steel centre piece *k*, of special form, which connects together the transom channels, braces, and bottom tie bar. The transom is built of rolled channel steel of standard section, and the

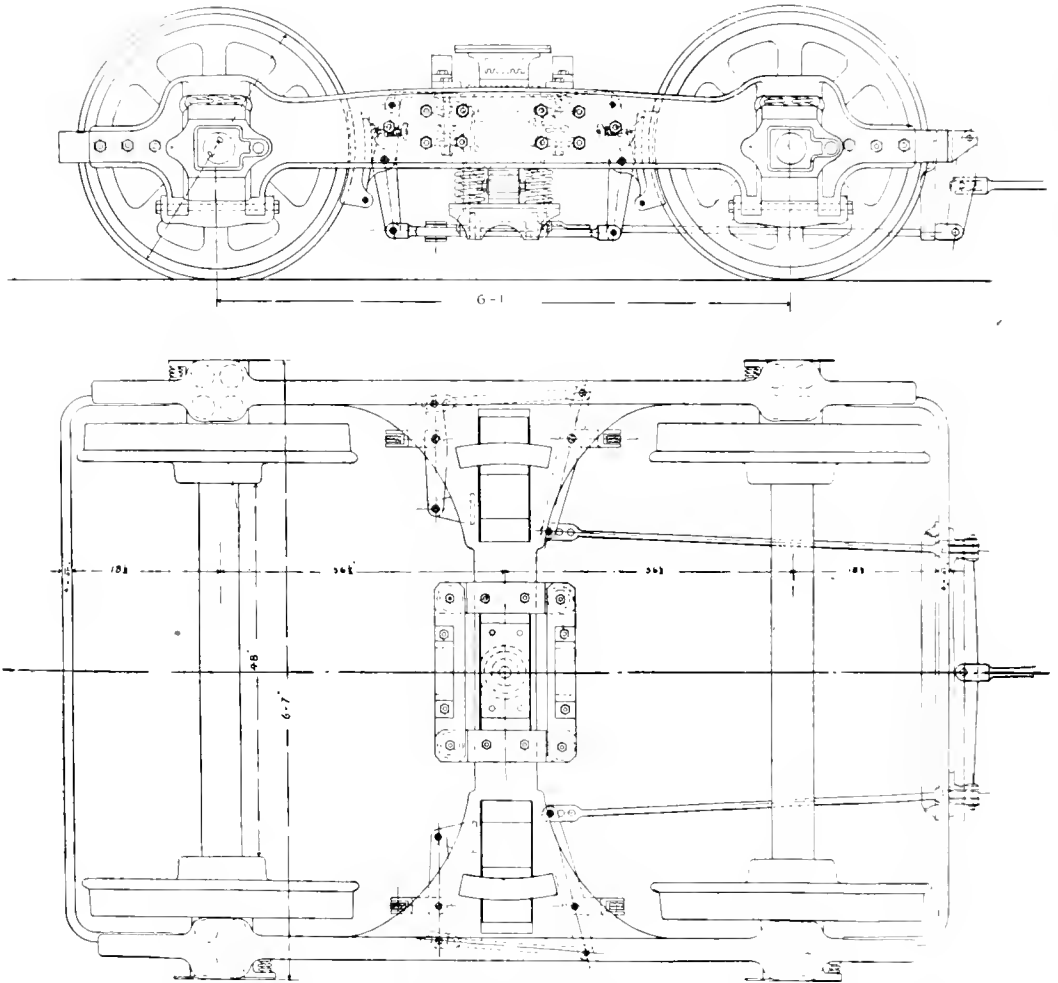

Fig. 111. CENTRAL LONDON RAILWAY: CAST STEEL TRAILER BOGIES. GENERAL ARRANGEMENT OF MCGUIRE TRUCK.

bolster, *l*, is of steel plates with interposed distance pieces *m*. The bolster rests on elliptical springs carried by steel plates *n*, suspended by bolts, *o*, from the transom channels, the height of the spring plate being regulated by the nuts on these bolts, so as to keep the car accurately to loading gauge, which is an important point in tube railway work. The transom is provided with angle steel brackets for the noses of the motors. Particular care has been taken to avoid the use of bolts except where they are absolutely necessary for construction or other reasons, rivets being employed



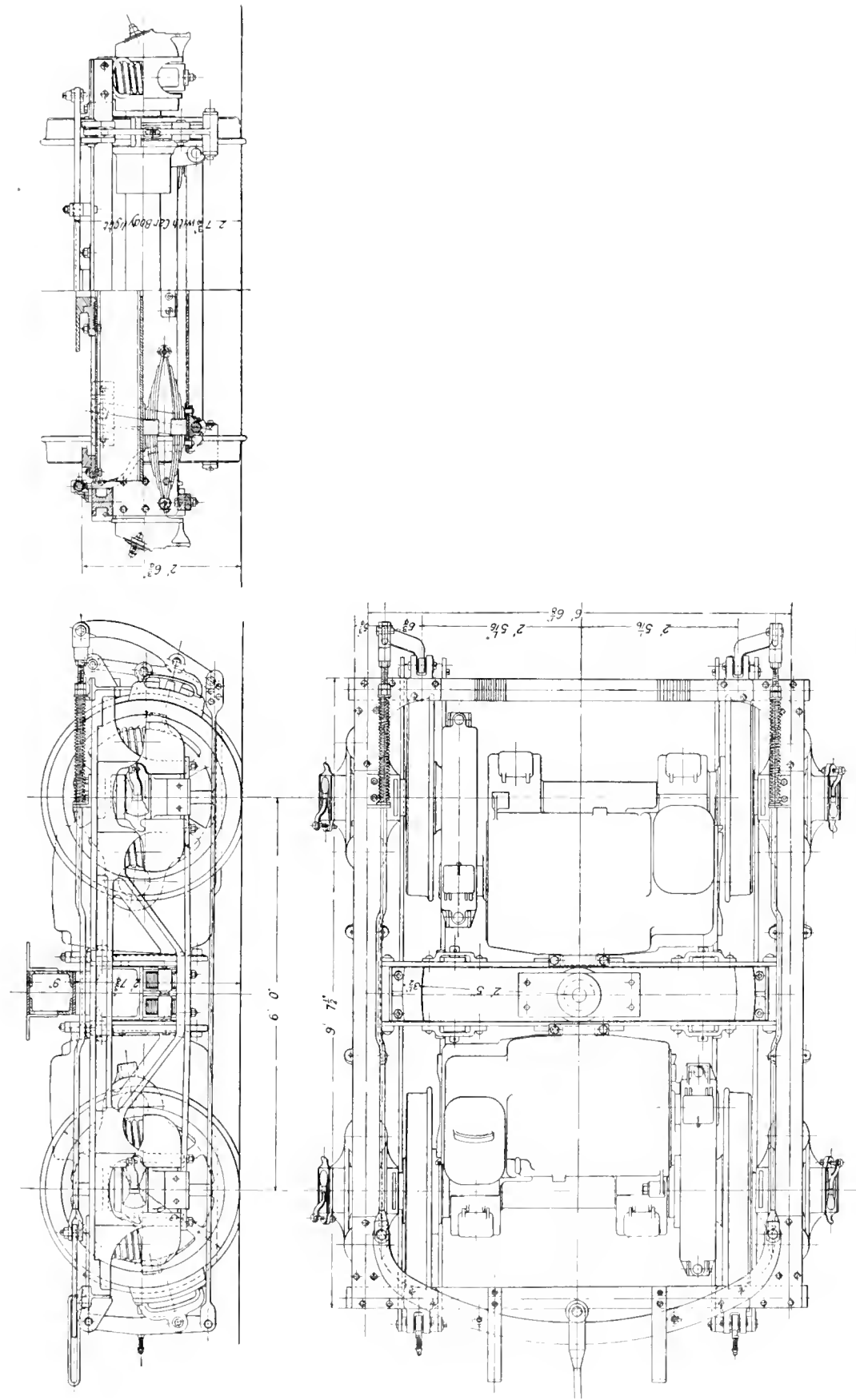

FIG. 409. HEDLEY'S HEAVY SERVICE MOTOR TRUCK USED AT CHICAGO.



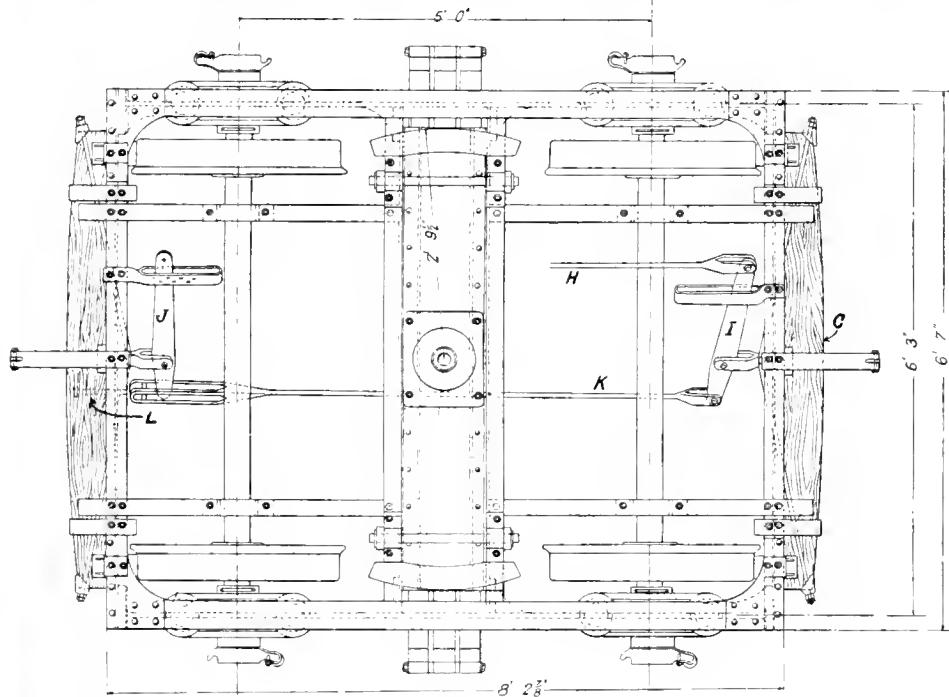
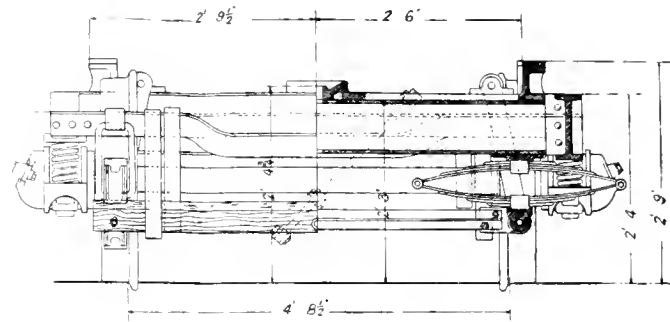
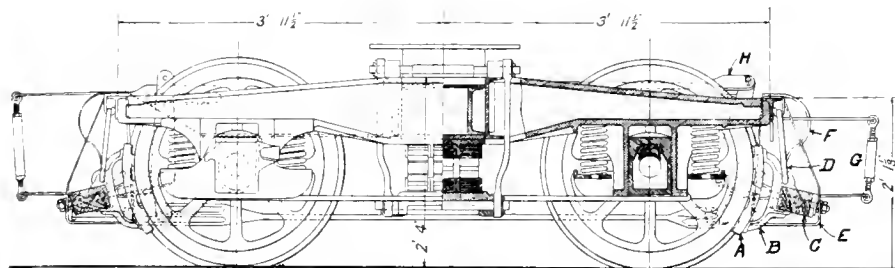

Fig. 410. CAST STEEL TRAILER TRUCK.

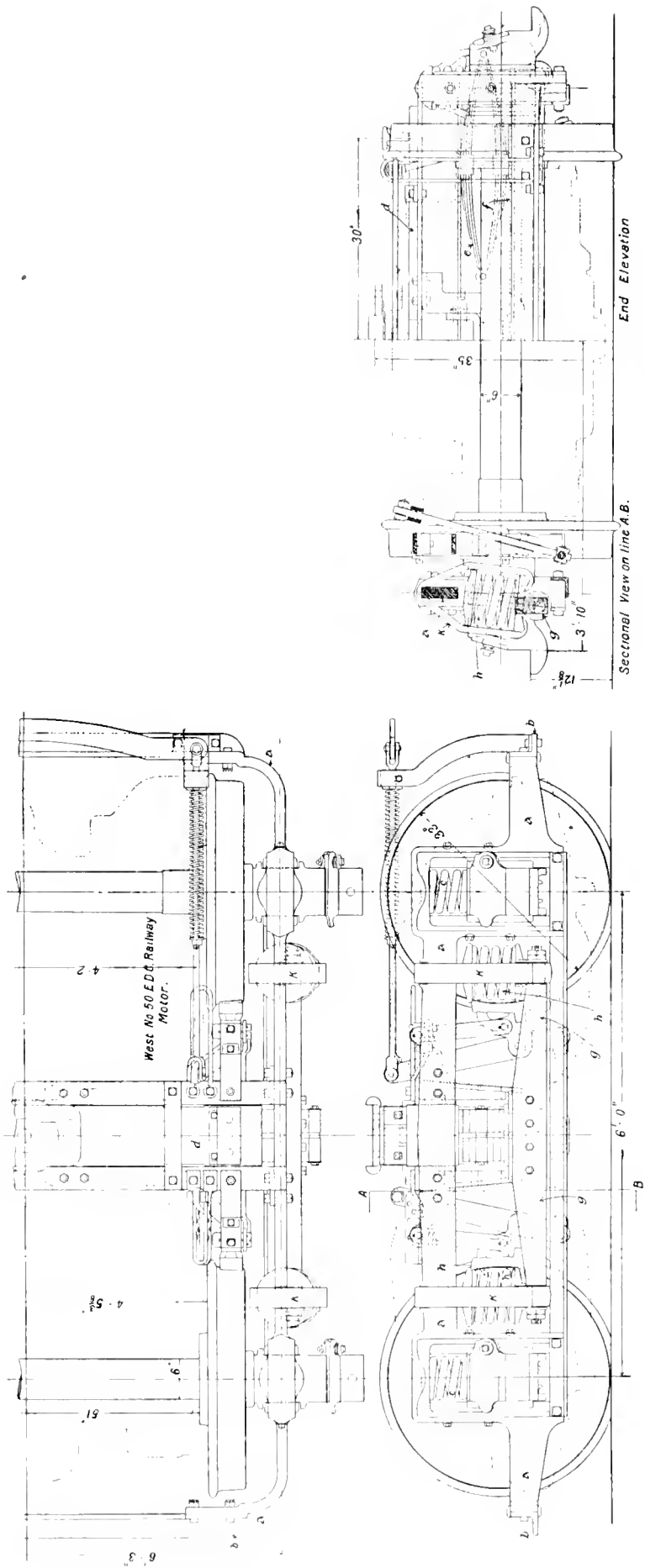
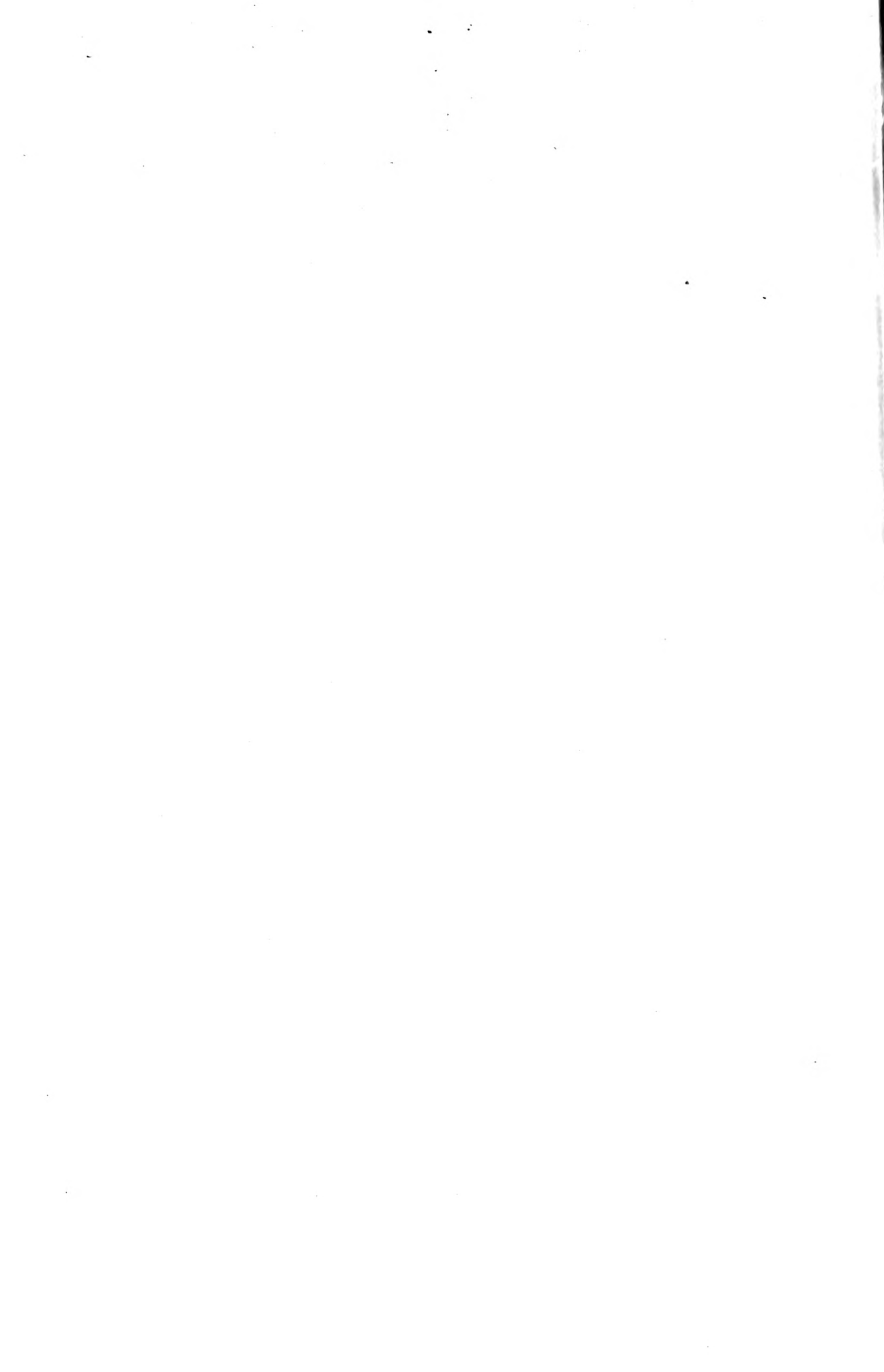

Fig. 412. J. G. BRILL COMPANY No. 27 E TRUCK FOR BROOKLYN HEIGHTS ELEVATED RAILWAY. (May 22nd, 1901.)



TRUCKS

wherever it is possible to do so. The brake foundation work on this bogie is of a special type, as the brake pull rod is unusually low down, owing to the under-frame of the coach being only 14 ins. above the rail level. The bogie centre is of cast steel, the lower part being so constructed as to contain a large supply of lubricants.

Soft cast steel has been largely employed for frames, especially in Chicago, where it seems to be a material particularly favoured both by manufacturer and by railway engineer. The material has given excellent service. One of the best known and most satisfactory frames of this type is that designed by Mr. Hedley for an elevated railway in Chicago. A motor bogie of this type is shown in Fig. 409. The motor bogie adopted by the Underground Electric Railways Co. of London for the Metropolitan District Railway (Fig. 407) is very similar to this. A trailer bogie of cast steel is shown in Fig. 410. A certain number of cast steel bogies have also been used on the Central London Railway, and have given very good results in low cost of maintenance

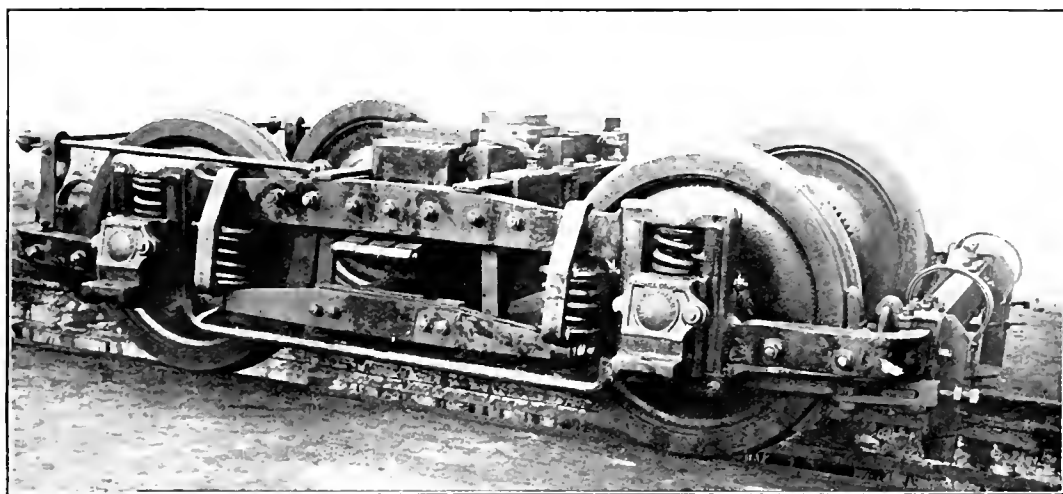

Fig. 413. BRILL TRUCK.

and in freedom from breakdowns; in these bogies the transoms and bolsters as well as the frames are of cast steel. Fig. 411 shows the general arrangement of these bogies.

The Brill bogie, to which allusion has already been made, hardly corresponds with either the European or American type. A typical Brill bogie is shown in Fig. 412. Each side frame, *a*, consists of a single piece, forged under hydraulic pressure, with jaws for the axle-boxes similar to those in an American locomotive frame. The end members, *b*, of the frame are of rolled angle steel. The frame is carried by helical springs, *c*, resting on the axle-boxes. The bolster, *d*, rests on elliptical springs *e*, but the swing beam *f*, on which these are supported, instead of being hung on swing links, is carried by two beams, *g*, which practically act as equalisers, and which are supported by means of helical springs, *h*, carried in stirrups, *k*, hung from the top frame and free to swing sideways. In this way exceptionally easy riding is obtained, there being three sets of springs in series. Photographs of Brill trucks are shown in Figs. 413 and 414.

Both cast steel and forged frames have an advantage in reducing the number of parts as compared with built-up frames. Solid and built-up frames have each,

ELECTRIC RAILWAY ENGINEERING

however, their own disadvantages. There must always be some uncertainty as to the internal condition of castings, and if a cast steel frame does break, it is liable to do so with much less warning than a forged or built-up frame. The forged frame is, undoubtedly, extremely good if great care be taken that the material is never worked below a proper heat. This, however, is difficult to ensure, and the forgings are sufficiently complex in shape to impose great initial strains on the metal if worked too cold. The built-up frame is free from these uncertainties as far as the individual parts are concerned, and in view of the almost universal employment of built-up plate frames for locomotives, except in America, it cannot seriously be urged that the number of riveted parts renders the frame unreliable. It is usually claimed by the advocates of cast steel that it is very much cheaper than either built-up or forged frames. The authors' experience, however, hardly bears out the claim. In this connection it may

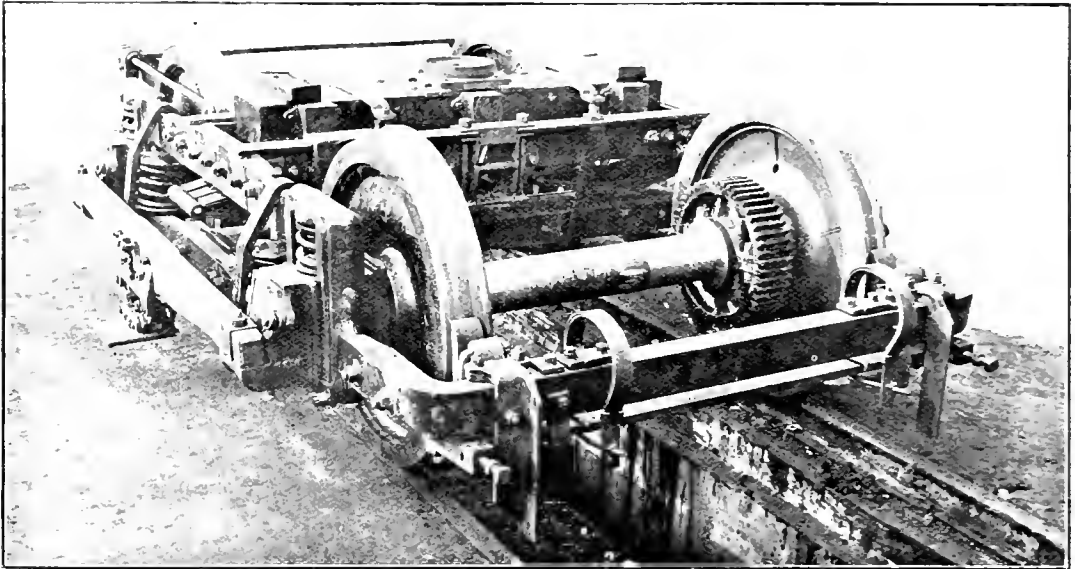

Fig. 414. BRILL TRUCK.

be of interest to note that the price paid for the cast steel bogies in use on the Central London Railway was almost exactly the same as that paid for the new standard bogie of Fig. 415. The number required in each case was small, but as the cast steel truck was fairly near the maker's standard, whereas the other was an entirely new design, the claim of cheapness hardly seems to be sustained. Quotations for another type of motor bogie in use on the same railway, and resembling the Manhattan motor-bogie, were also almost exactly the same figure.

On the whole, the authors prefer a built-up frame to either of the other two types, and it will be seen from the examples given that the majority of railway engineers in this country are of the same opinion.

With regard to the details of the frame design, a weak spot found in several designs is the part of the frame between the jaws of the axle guards. With inner-hung brakes and a frame either equalised or having springs immediately on the axle-boxes, the stresses at this point are small, and are practically limited to those due to

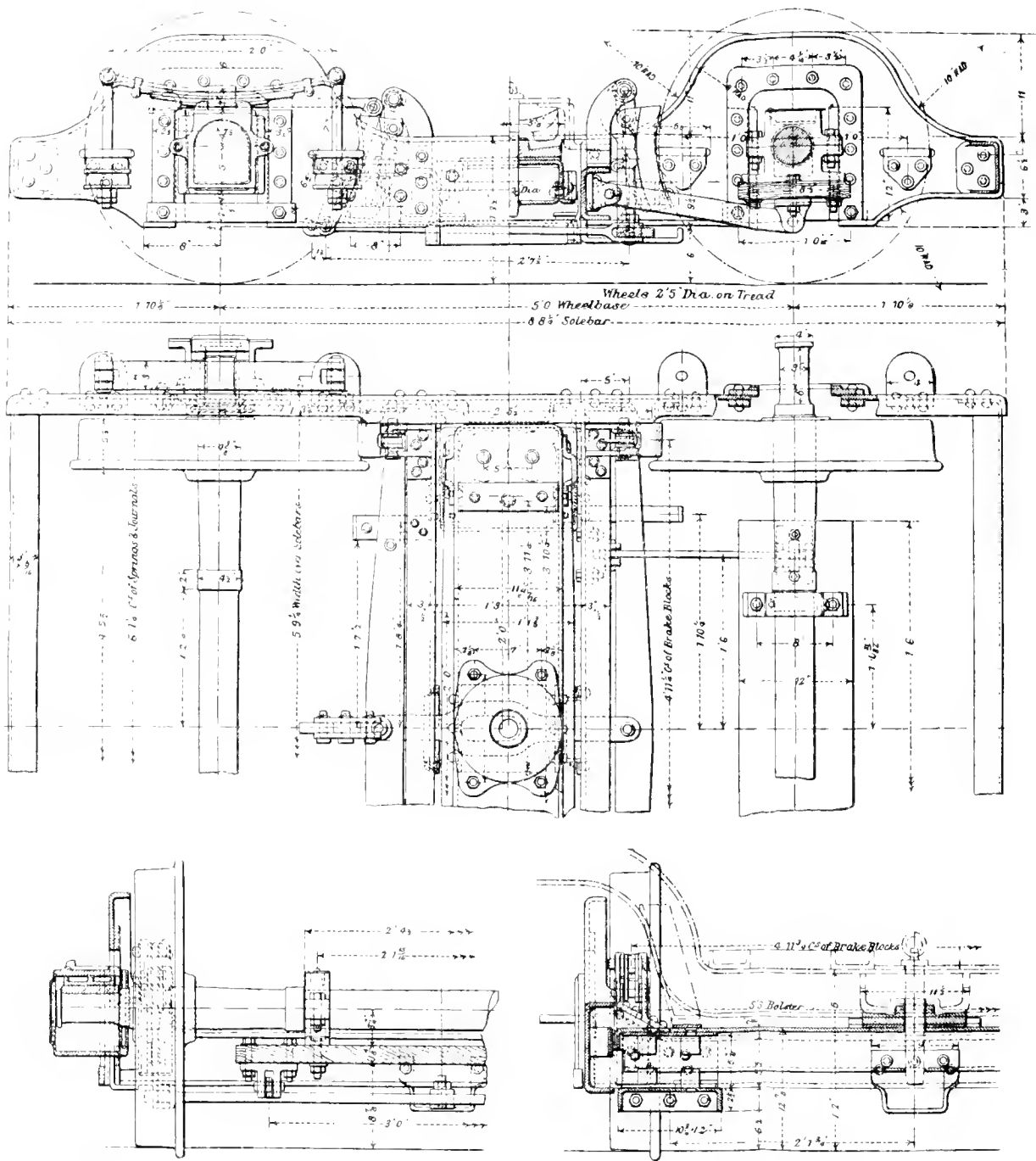

Fig. 415. BOGIE TRUCK UNDER TRAILER END OF CENTRAL LONDON RAILWAY CARRIAGE.



TRUCKS

the forward or backward thrust of the axle. With outside-hung brakes, however, and with elliptical springs over the axle-boxes, or with two helical springs one each side of the axle-box, the stresses are obviously greatly increased: it is not uncommon, however, to find bogies with these arrangements, and with frames having light top members properly braced so as to form a truss between the axle guards and the transom, while between the jaws of the axle guards, where the bending moment, apart from the action of the brakes, may be quite a quarter or even as much as a third of that in the braced part, the frame consists of the top member only, without reinforcing except for such support as is given by the axle guard keep. The result is that the axle guards spread at the lower end of the jaws, and in some cases cracks start upwards and outwards from the corners of the jaws.

Another fault sometimes found is the indiscriminate use of bolts instead of rivets in truck construction. This, however, is not a common fault in English work. Some manufacturers maintain that a fitted bolt is better than a rivet in any case. This claim, however, can hardly be sustained in face of the fact that in all other constructional work experience has led to the universal use of rivets, bolts only being allowed in special cases where riveting is impossible. Under the constant vibration to which bogies are subjected, bolts are even more objectionable than in ordinary constructional work, requiring constant attention to ensure that the nuts do not jar loose. Bolts should never be employed where rivets can be used, except for parts that must in the ordinary course be removed periodically for renewals. It is, of course, necessary that the riveting should be properly done, but in the authors' experience it is much more difficult to ensure good fitting bolts than good riveting.

The car body is usually connected to the bolster of the bogie by means of male and female centre bearings M and N (see Fig. 400, facing p. 432), preferably of cast steel, rubbing plates O being provided near the ends of the bolster and the car body bolster so as to prevent the car body from rolling. In order to allow the bogie to swivel freely, the usual practice is to allow a slight clearance between the upper and lower side rubbing plates, so that normally the whole load is carried on the centre bearing. Under these conditions the pressure should not exceed 400 lbs. per square inch on the bearing. It is of particular importance that the pressure be kept low, since the centre bearing is required to be constantly starting from a state of rest, and, as Thurston has shown, the coefficient of friction, under this condition, increases as the cube root of the pressure, whereas with a lubricated journal, when running, it diminishes with an increase of pressure. Both centre and side bearings should preferably be constructed so as to contain a supply of lubricant, and for this reason the female centre is usually on the bogie and the male centre on the under-frame of the car body.

It is of very great importance to secure easy swivelling of the bogie under the car body, and this will usually require more attention in the case of motor than in that of trailer bogies. With motor bogies there is, in the first place, much greater difficulty in swivelling owing to the increased load on the centre and side bearings—motor coaches being of necessity heavier than trailer coaches for similar service—and, in the second place, much more serious results follow from insufficient swivelling. There can be no doubt that by far the greatest part of the wear on rails and wheel flanges on curves is due to the grinding of the outer leading wheel against the outer rail caused by the incorrect position of the bogie relative to the rails. Where the coach is subjected to pull only, as in the case of a steam train, the pull of the couplings will tend to lessen

ELECTRIC RAILWAY ENGINEERING

this effect, but if the coach is being pushed, the effect will be greatly increased, and on a motor-driven bogie it becomes a very serious matter. With the ordinary side rubbing plates, even if they are adjusted so that when the car is stationary the whole weight of the body rests on the centre bearing, it will be found that on curves where the conditions as to speed and radius are at all severe the pressure on the outer bearing will be so high that the bogie will not swivel without great difficulty, the difficulty being naturally greatest on the sharpest curves, that is at the very place where it is most required to swivel easily. As far as steam railways are concerned, the general consensus of opinion of authorities on rolling stock appears to be that the ordinary type of centre plate and side rubbing plate is good enough and has advantages in points of simplicity over any special devices. For electric railway conditions it may be worth while in many cases to employ ball bearings for the centre plates and rollers for the side bearings, the additional expense being more than offset by the saving in wear of wheels and rails and the reduced strains in the bogie frame. The practice of having the car body carried on the side bearings instead of on the centre bearing is advocated by a considerable number of railway engineers. Car bodies so mounted roll less than with the more usual arrangement, which is a very important consideration in tube railway working. If this practice be adopted it will be found almost imperative to employ ball or roller bearings. A pin termed a king pin or centre pin is usually passed through a central hole in the centre bearings. The necessity for this in ordinary running is not very obvious, but in case of derailment it may serve to keep the bogie in place under a shock that would unseat the centre bearing.

We may now pass on to the consideration of details which apply to either rigid or bogie trucks. Of these details we may conveniently consider first the springs. Semi-elliptical springs for locomotives are usually designed in accordance with the following formulæ, due to D. K. Clark :

$$\begin{aligned}
 \text{Let } S &= \text{span of spring in inches.} \\
 B &= \text{breadth of plate in inches.} \\
 T &= \text{thickness of plate in sixteenths of an inch.} \\
 N &= \text{number of plates.} \\
 D &= \text{deflection in inches per ton of load.} \\
 L &= \text{safe load on spring in tons.} \\
 L &= \frac{B T^2 N}{11.3 S} \\
 N &= \frac{11.3 S L}{B T^2} \\
 D &= \frac{0.14 S^3}{T^3 B N}
 \end{aligned}$$

In modern practice the coefficient of 11.3 is regarded as somewhat small, and a figure of 14 or even 15 is employed. Taking a coefficient of 14 in these formulæ, gives a normal safe deflection when fully loaded and at rest of $\frac{0.01 S^2}{T}$.

A complete elliptical spring can, of course, be treated simply as two semi-elliptics in series, the maximum safe load being the same as for the semi-elliptic, while the deflection produced by the load will be double.

TRUCKS

For helical springs, Rankin gives the following formulæ:

Let R = mean radius in inches.

d = diameter of spring steel in inches.

b = width of spring steel (square) in inches.

N = number of coils.

D = deflection in inches per ton of load.

G = coefficient of transverse elasticity (about one-third of the modulus of elasticity, or about 5,000 tons).

F = maximum safe shearing stress.

L = maximum safe steady load (say about 15 tons).

$$D = \frac{64 N R^3}{G d^4} = 0.013 \frac{N R^3}{d^4}.$$

$$W = \frac{0.196 F d^3}{R} = 2 - \frac{d^3}{R} \text{ approximately.}$$

This gives a maximum safe deflection at rest of

$$\frac{12.57 N F R^2}{G d} = \frac{0.0377 N R^2}{d}.$$

With square section steel these figures become—

$$D = \frac{12 N R^3}{G b^4} = \frac{0.0075 N R^3}{b^4}.$$

$$W = 4.74 \frac{b^3}{R}.$$

$$\text{Maximum safe deflection at rest} = \frac{0.035 N R^2}{b}.$$

The arrangement of brake foundation work is a matter that vitally affects the questions of maintenance and safe running, especially when the speed is high in relation to the frequency of stops.

The main points to be borne in mind in designing brake work are—

(1) It must be equalised; that is, the pressure on the wheels must be equal (or adjusted to the loads on the wheels).

(2) The blocks must be hung so as to wear evenly over their whole surface.

(3) The blocks must clear the wheels properly under all conditions except when brakes are set.

(4) Means must be provided for quickly and readily taking up wear till the brake blocks are reduced to the minimum thickness which is considered safe.

(5) The blocks must be readily removable for renewals.

On rigid wheel base rolling stock it is usual to employ brake blocks on each side of the wheel, and this practice is a very desirable one where it does not involve too much crowding up of the brake foundation work, as it avoids the severe stresses on the axles caused by pressure on one side only.¹ It does not, of course, avoid the much smaller side thrust due to the fact that the retarding action of the wheels is transmitted through the axles.

On bogies, however, and especially motor bogies under cars, it is often difficult to accommodate the foundation work required for double brake blocks and still more

¹ The resultant of the brake-block pressure and the load may amount to 40 per cent. more than the load alone.

ELECTRIC RAILWAY ENGINEERING

difficult to give enough access to the foundation work to ensure its proper inspection and easy adjustment, and single blocks are consequently more common.

The question, then, that has to be settled, is that of the relative advantages of inside-hung and outside-hung brake blocks, that is, whether the blocks are to be between the wheels, as in Fig. 408, or outside them, as in Fig. 410. On American steam railways, outside-hung brakes are almost exclusively employed, both on goods and passenger stock, and where this arrangement is not prevented by other conditions, it should always be adopted, the reduction in maintenance cost due to the easy access to the brake work being sufficient to outweigh all other considerations. The outside-hung brake, however, has the disadvantage that when applied it pulls down one end of the bogie frame and pushes up the other, thus subjecting the bogie frame to stresses which it need not otherwise carry, and increasing the load on the journals. This is particularly noticeable in the case of equalised bogies. Normally there is no vertical bending moment in the frame except between the points of support, *i.e.*, the equaliser spring pockets. When brakes are applied, however, a considerable load is applied at the end of the frame, that is practically at the end of a cantilever supported at the spring pocket, and it is obvious that the frame must be considerably stiffened to carry this. It will be noticed that in Fig. 405 this is done by a strut from the bottom of the axle guard to the corner of the frame. The downward pull at the leading end is also liable to bring the top of the axle guards down hard on to the equaliser on the top of the axle-box, thus producing the unpleasant jarring frequently felt in rolling stock with equalised bogies when brakes are applied. An attempt has been made to overcome this in the so-called "non-tilting" frame, which is an equalised frame with additional helical springs over each box. It is obvious, however, that the equalisation must diminish as the non-tilting properties are improved.

On bogies other than those of the equalised type the disadvantages of the outside-hung brake are much reduced, since, the frame being supported directly over the axle, the vertical bending moment at the point of support due to the brake block pull is about halved.

The American type of brake foundation for steam railway passenger stock is well illustrated in the cast steel trailer bogie shown in Fig. 410. The brake blocks A are carried in steel castings B (brake heads), each pair of brake heads being coupled by a brake beam C, and suspended from the frame by the brake hangers D. Safety hangers E are also provided to support the brake beams in the event of a hanger breaking, and release springs F to hold the brake blocks off the wheels. In some instances the release spring also acts as a safety hanger. The angle of the brake beams can be adjusted by means of a turnbuckle G, so as to ensure the correct position of the brake blocks as they wear out. The pull rod H on the car body is attached to the upper end of the live lever I, which is at the outer end of the bogie, and is attached near its lower end to the brake beam. The lower end of this lever is connected to the lower end of the dead lever J by means of the brake rod K. The dead lever is attached near its lower end to the brake beam at the inner end of the bogie, and at its upper end to a fulcrum on the bogie frame, which is adjustable to take up the wear of the blocks. In the brake foundation of Fig. 410 a further adjustment can be made, the relative positions of J and K being adjusted by the set screw L.

This arrangement is not usually a suitable one for motor bogies, owing to the difficulty of finding room for the beams and the lower brake rod on account of the collecting gear and motors, and the usual plan is to dispense with beams and have a live and dead lever and pull-rod on each side of the bogie, the motion of the car body

TRUCKS

pull-rod being communicated to the live levers through the two upper pull-rods connected by a yoke at the inner end of the bogie. The yoke is in the form of an arc of a circle struck with the bogie centre as its centre, so as to allow the bogie to swing without altering the setting of the brakes. This arrangement is illustrated by the North-Eastern and the cast steel motor bogie shown in Figs. 400 and 409 respectively.

When inside-hung brakes are employed, whether with or without beams, the individual details are quite similar to those for outside-hung brakes; the only differences are in the arrangement, the live lever being near the inner end and the dead lever nearer the outer end of the bogie, and the lower brake rod being in thrust

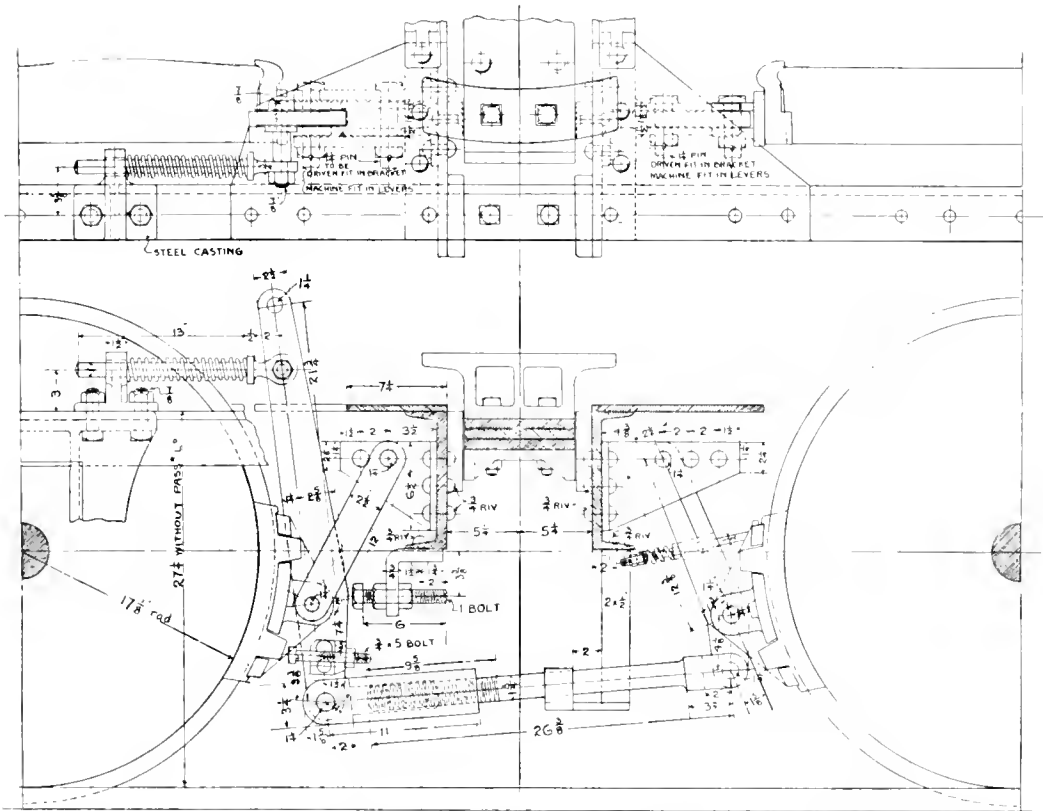

Fig. 416. MOTOR TRUCK SHOWING ARRANGEMENT OF BRAKES ON MANHATTAN RAILWAY.

instead of in tension. A suitable arrangement with beams is shown in the trailer bogie in use on the Central London Railway (Fig. 415), and the corresponding arrangement without beam in the Manhattan Elevated motor bogie (Fig. 416). As has already been stated, the Central London motor bogie brake gear (Fig. 408) is somewhat unusual in its arrangement owing to the small height of the pull-rod on the car body. In general it may be described as an inner-hung brake foundation turned upside down, the dead lever fulcrums being at the lower end of the levers and the brake rod at the upper end; there being no convenient method of supporting a yoke for connecting to the car body pull-rod, it is replaced by a beam suspended by hangers from the end of the bogie frame.

TRUCKS

country by certain railways where the schedule speed is high in consideration of the frequency of the stops. The brake heads and shoes adopted for the District Railway are the standards of the American Master Car-builders' Association, and are shown in Figs. 417 to 419. There are two slotted lugs on the head and one on the shoe. The lug on the shoe A comes between those on the head B, and a curved tapered key of rectangular section is passed through the slots and rests between two lugs at the top and two at the bottom of the head, thus securing the shoe. This pattern is very

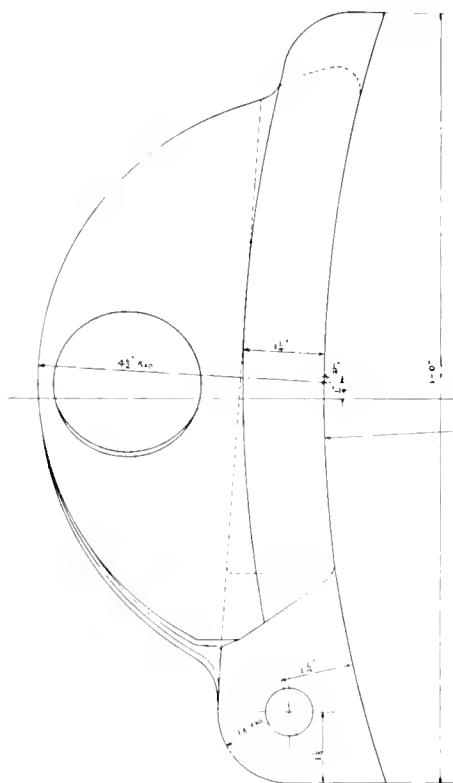

Fig. 420.

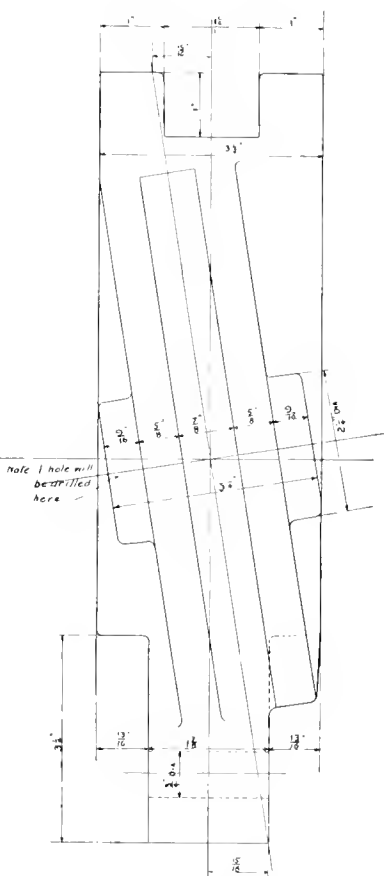

Fig. 421.

Figs. 420, 421. CENTRAL LONDON RAILWAY: NEW BRAKE BLOCK FOR MOTOR TRUCKS.

satisfactory where the brake shoes are readily accessible, as is usually the case with outside-hung brakes. On cars where the framing comes down over the bogie, however, it is found to be very inconvenient, owing to the difficulty of removing the key. These conditions occur both on the motor and on the trailer bogies on the Central London Railway, and to meet them the form of head shown in Figs. 420 and 421 was adopted. The shoe is provided with a longitudinal rib on the back, which fits loosely into a corresponding groove in the head. The shoe also has a lip which looks over the upper end of the head, resting between two lugs on the head, which prevent

ELECTRIC RAILWAY ENGINEERING

movement sideways. At the lower end there is a lug on the head, which fits loosely between two lugs on the shoe, a pin being then passed through holes in the lugs. The whole arrangement can also be seen in Fig. 408. To remove a shoe, all that has to be done is to remove this pin and raise the shoe about three-eighths of an inch. This arrangement works quite satisfactorily, and enables trains to be reblocked in a remarkably short time.

Both the Lancashire and Yorkshire and the North-Eastern Railways adhere to the standard English practice of attaching the brake block direct to the levers, but, the stops being much less frequent on these lines, it is probable that blocks will not have to be renewed so often as on lines of the Central London or District Railway type. Considerable difference of opinion exists as to whether it is desirable or otherwise that the brake shoes should engage the flange or only the tread of the wheel. On steam locomotives the blocks engage the flanges in most cases, and in America, but never in this country, on the coaches also. On motor bogies it is almost universal in America for the blocks to engage the flanges, and it is also very common practice in this country. Instances of the blocks engaging the flanges are the motor bogies on the North-Eastern Railway (Fig. 400) and the cast steel bogie of Fig. 409, whilst the alternative is adopted on the Central London (Fig. 408), the Lancashire and Yorkshire (Fig. 402), and the cast steel trailer bogie (Fig. 410). Where braking conditions are severe, the wear of the block on the back of the flange has been found objectionable with the English section of tyre, as, owing to the back of the flange being vertical for more than half its depth, it is impossible to correct this when turning up the wheels. This effect is increased by the tendency of the blocks to travel outwards when the brakes are applied, owing to the coning of the wheels. In more than one instance, the grooved type of block has been abandoned for this reason. With the American section of tyre, however, the back of the flange being curved throughout its whole depth, the true section of the flange can always be restored by turning. For this country, therefore, the authors are of opinion that the plain block bearing only on the tread of the wheel is decidedly preferable, especially where braking is severe. When the blocks bear only on the tread it becomes necessary to provide some means for preventing them from travelling outwards owing to the coning of the wheels. Where brake beams are employed these will be sufficient; where they are not used the levers on opposite sides of the bogie should be tied by a cross-bar, as in the case of the Central London and Lancashire and Yorkshire Railways. The extensive use of grooved blocks on locomotive and on motor-driven wheels is probably due more to the difficulty of finding room for such cross-bars than to any inherent advantages of the grooved block. The brake blocks should preferably be of cold blast cast iron, unless some one of the several patent brake blocks on the market is used. Some of these patent brake blocks give very good results. Brake heads should be of soft cast steel. Pull-rods should preferably be of hammered scrap iron, though there is not much to choose between this and the best qualities of iron bar. Levers and hangers should be of the best quality wrought iron, fixed brackets of wrought iron or mild steel. In America the beams are frequently of timber, sometimes braced with wrought iron bars; it is, of course, an advantage to have all parts of the brake foundation as light as possible in order to secure quick application, but, in the writers' opinion, if special lightness is desired, a steel tube truss is a more logical arrangement where the bogie is otherwise of metal throughout. In the great majority of cases, however, a flat wrought iron or mild steel bar is perfectly satisfactory for brake-beams. Holes for pins in brake rigging should be drilled (never punched) $\frac{1}{32}$ in. slack for the pins, and both holes and

TRUCKS

pins should be case-hardened. To reduce the number of spare parts it is very desirable to use one size of pin throughout, say $1\frac{1}{16}$ ins., the holes being $1\frac{1}{8}$ ins. Pins are best secured by means of split pins with washers under them; the washer is an essential part of the arrangement. Safety hangers and brackets should be used with discretion; a certain number of such precautions are no doubt advisable, but in brake work, as in most other such matters, it is better to make a sound job of the actual work than to add numerous safety devices, and it not infrequently happens that more trouble is given by the hangers than by the brake foundation proper.

The method of attaching the motors to the bogie is a matter of prime importance. Generally speaking, the most satisfactory plan is the usual one of placing the motors between the axles and supporting each motor on one side by bearings on the axle, so as to keep the gear properly meshed, and on the other by a spring support attached to the bogie frame. In the case of a heavy motor there is usually a nose in the frame casting which rests on a bar carried by springs on the transom. The authors are inclined to lay considerable stress on the spring support; its effect on the permanent way or the coach body is not very important, since, in any case, there will be a set of springs between each of these and the motor; but in more than one case it has been found that where the nose rests on a rigid bracket both the nose and bracket wear very rapidly, owing to the fact that, as the motor bearings follow the movement of the axle relative to the frame, the nose is drawn to and fro along the supporting bracket. Similar effects may be produced by side play between the axle-boxes and axle guards, by end play of the motor on the axle, and by lateral bending in the bogie frame. If, however, the nose of the motor is clamped to a yielding spring support, the effects will be much reduced.

This method of suspending the motor has, of course, the effect of putting from 50 to 60 per cent. of its weight direct on the axle, which generally means increasing the non-spring-borne load at least 100 per cent., and occasionally applying shocks to the axle equal to several times the weight of the motor, when the axle suddenly moves or stops, moving relatively to the bogie frame. Consequently numerous attempts have been made from time to time to modify the arrangement so as to take the weight of the motor entirely off the axle. The defect of all such devices with which the authors are acquainted, however, is that, as the motor must be centred on the axle on account of the gear, it will still have to move with the axle, so that the conditions for a horizontal movement are unchanged, whilst for a sudden vertical movement all that can be done is to convert a rotation about the nose into a rotation about the centre of gravity. The effect of this in almost every case is to increase instead of to decrease the shocks to which the axle is subject. To explain this, we may assume, with a close enough approximation to accuracy, that the motor is a uniform cylinder with its centre of gravity in the axis of the armature shaft, and that the centre of the nose suspension and the axle suspension are at the periphery, at opposite ends of a horizontal diameter. The radius of gyration of the motor rotating about the armature shaft will then be $\frac{1}{\sqrt{2}}$ of the distance from the axis of the armature shaft to the nose suspension or to the axis of the driving axle. For a given vertical movement of the axle, therefore, the corresponding average travel, and therefore the acceleration of the motor, will be $\frac{1}{2}$ with nose suspension, and $\frac{1}{\sqrt{2}}$ with centre of gravity suspension.

The leverage of the axle in the two cases will obviously be in the same ratio, so that

ELECTRIC RAILWAY ENGINEERING

the force required to be exerted by—that is, the blow to—the axle will be in the ratio of $\left(\frac{1}{2}\right)^2$ to $\left(\frac{1}{\sqrt{2}}\right)^2$. The shock to the axle will therefore be twice as great with centre of gravity suspension as with nose suspension. Of course with centre of gravity suspension the blow to the axle will be the same for upward or downward travel of the axle, whereas with nose suspension the total load will be increased by the weight of the motor on the axle for upward movement and decreased by it for downward movement, so that up to the point where the movement is sufficiently rapid to make the blow greater than the weight of the motor the advantage is with the centre of gravity suspension. Such blows as these, however, are too small for consideration compared with blows of several times the weight of the motor, which must occur at frequent intervals, and then the advantage obviously lies on the side of the nose suspension. For instance, if with a certain vertical movement of the axle in a certain time the force applied at the axle with centre of gravity suspension is six times the weight of the motor, the corresponding force with nose suspension would be three and a half times the weight of the motor for an upward movement (half its weight being on the axle), and two and a half for a downward movement.

If, on the other hand, the suspension be moved further away from the axle than the outside of the motor case, the travel of the motor for a given vertical travel of the axle will again be increased, so that it appears that the ordinary nose suspension approximates very closely to the most theoretically favourable one, as far as blows to both motor and axle are concerned, while, even if it were not theoretically the best point of suspension, the simplicity of the arrangement would give it a great advantage over any other system.

The proper position of the motors is obviously between the axles as far as good running of the bogie is concerned. In certain cases, however, where the construction of the cars renders it necessary to have the bogie between the side sills, it may be necessary to so reduce the wheel base in order to allow the bogie to swivel sufficiently that there is no room for the motors between the axles. This requires placing the motors outside of the axles, but this arrangement should never be employed where it is possible to avoid it, since, owing to the vertical and transverse horizontal oscillations due to the short wheel base and great overhanging loads on the ends, the bogie will hardly ever rise really well at anything above moderate speeds. In the first experimental motor cars used on the Central London Railway, which were converted from trailer cars, the bogie had to swing between the sills, which came just at the most inconvenient height, *i.e.*, opposite the axle-boxes. It was thought preferable, however, to use bogies with inside-hung motors, although it necessitated using very short journals, the actual size of the journals on these bogies being 6 ins. \times 4 ins. In the motor car finally adopted, the design of the under-frame was modified to get over this difficulty as far as possible. The journals were increased to the more usual proportions of 8 ins. \times 4½ ins., but the wheel base had still to be kept down to 6 ft., and as the motors were larger than on the experimental trains, it was found necessary to dispense with a spring support for the motor. This, however, was considered the lesser evil of the two. The only other point in favour of outside-hung motors is that when only one motor is used on a bogie, suspending it outside the axles will greatly increase the weight on the driving wheels. Such an arrangement is undoubtedly preferable to the use of “maximum traction” bogies with unequal wheels, and will give all the adhesion required for any practical acceleration on the comparatively clean rails available in railway work. It is not, however, a desirable arrangement except for quite moderate

TRUCKS

speeds. It is also only applicable to single cars, since, if there is more than one car on the train, it is undoubtedly correct practice to have a motor bogie and trailer bogie on each motor car rather than to have one motor on each bogie. In fact, even in the case of single cars, no great objection can be taken to having one motor bogie and one trailer bogie, since the experience of several English railways with steam motor coaches goes to show that they run quite satisfactorily whether the engine end is leading or trailing. The advantages of placing both motors on one bogie are—

- (1) A cheaper type of bogie can be used for the trailer.
- (2) When motor bearings, gear, etc., have to be removed, only one bogie has to be removed.
- (3) Car wiring is greatly simplified and reduced in quantity.

The method of carrying the electrical contact devices on the bogie is really more a question of electrical equipment than of rolling stock design, since it obviously depends on the system of distribution more than on any other point. It has come to be a recognised principle in all the more modern installations that the contact shoe shall be suspended from a point at a fixed distance above the rail, in order to reduce the play between the shoe and the suspension. On the City and South London Railway, however, the shoes were originally suspended from the locomotive under-frame, and this arrangement having been found to work fairly satisfactorily, is still continued on that railway. The authors, however, are of the opinion that the balance of advantage rests with the suspension at a fixed height. In order to secure this fixed height, the suspension must be attached to the axles, axle-boxes, or equalisers. The first of these is adopted on the Central London, where the third rail is in the middle of the four-foot way. The shoes on the motor bogies are suspended from a plank attached to the motor suspension bearings on the axle. A preferable arrangement on general grounds would undoubtedly have been to attach the plank to the equalisers, the shoe being under the transom. This arrangement was used on the bogies for the locomotives with geared motors. The wheel base of the motor car bogies, however, is so short that the shoes would have been almost inaccessible, and dangerously close to the motors. On the trailer bogies¹ of motor cars the plank may be attached to special bearings on the axle, and held from rotating by links attached to the end cross members of the bogie frame. This again is not recommended as an ideal arrangement, but was adopted as the best for the confined space available at the trailer end of the coach.

The second arrangement—suspension from the axle-boxes—is adopted on the North-Eastern and the District Railways, and is, in fact, practically standard on non-equalised bogies where the third rail is outside the four-foot. The shoe plank is in these cases attached to lugs on the boxes. The third arrangement is used on the Lancashire and Yorkshire Railway, and is the usual one with equalised bogies where the third rail is outside the four-foot. If the wheel base is long enough to give proper clearance from the motors, it may also be employed with a third rail in the four-foot way, and, as stated above, it was so used on certain bogies on the Central London Railway.

With regard to axle-boxes there is but little difference between practice in this country and America, the standard arrangement in either case being a cast iron or steel box having a circular opening at the back fitted with a "dust-guard" or "oil-guard"

¹ This applies to cases where it is required to provide shoes on both bogies of the motor car so as to bridge the gaps in the third rail at points and crossings.

ELECTRIC RAILWAY ENGINEERING

of leather or similar material, and an opening in front to allow access to the journal and brass, with a removable cover. In this country the standard railway practice is to have this cover a machined fit on the front of the box, and secure it with bolts passing through lugs on the cover and the box, and it is usual to specify that the box should be watertight. The standard practice in America as laid down by the Master Car-builders' Association, however, is a sheet iron cover opening upwards and outwards, and held closed by a flat spring. The Master Mechanics' Association standard arrangement of this type of box, which has also been adopted by the American Street Railway Association, is for the cover to open edgewise, it being pivoted at one side and pressed against the box by a helical spring on the pivot bolt. When closed,

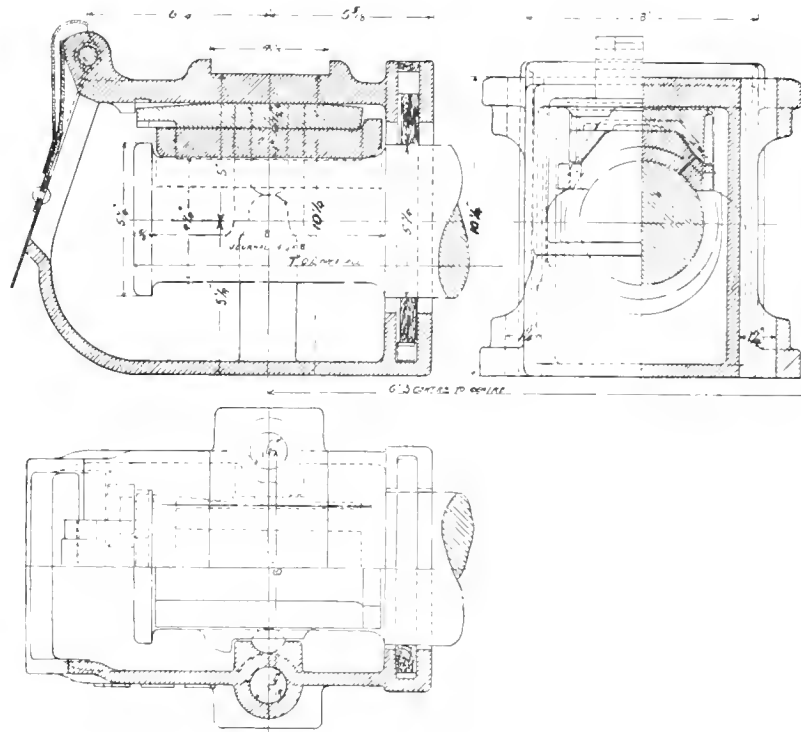
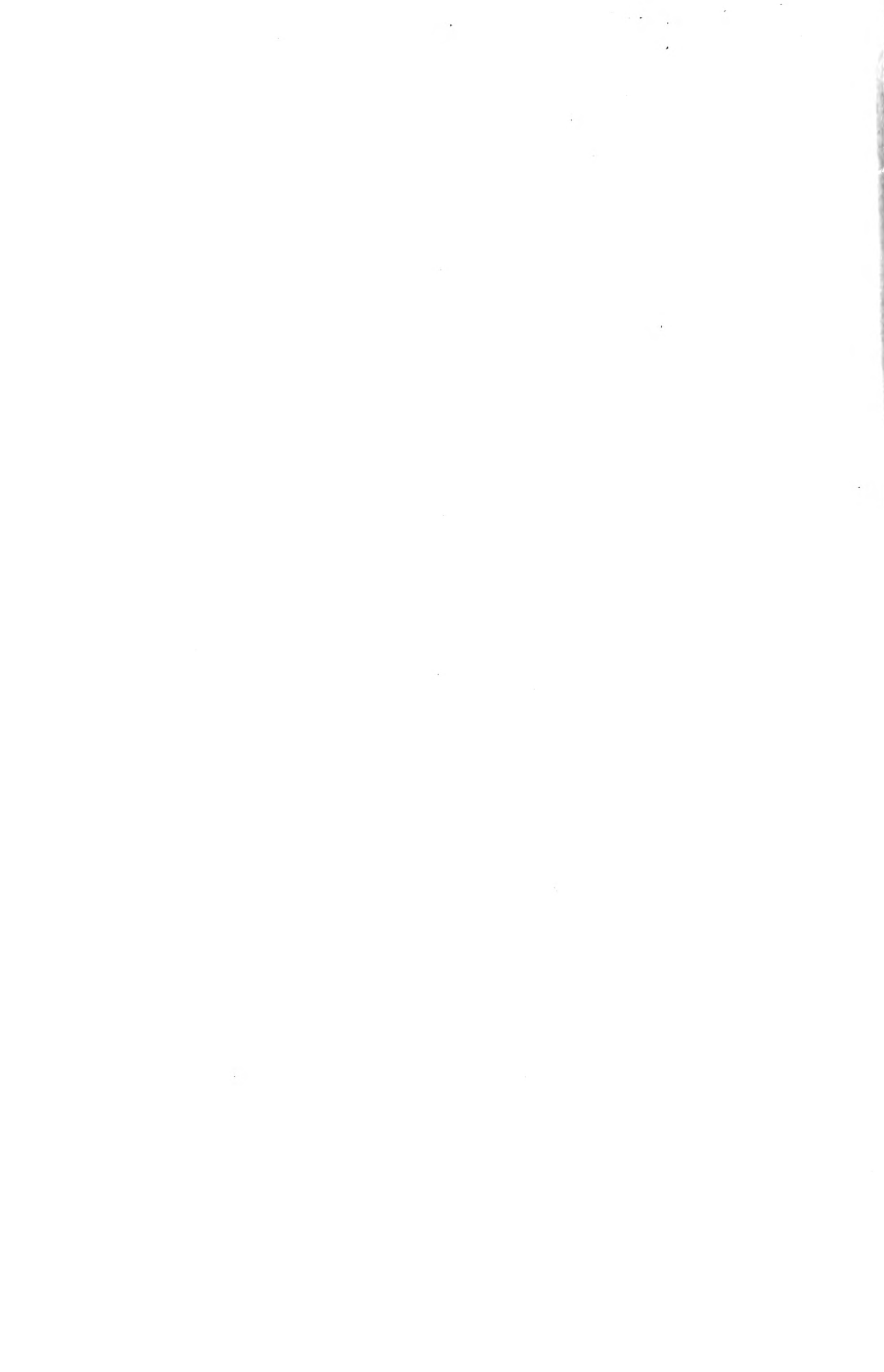

Fig. 423. MASTER CAR-BUILDERS' STANDARD AXLE-BOX FOR A $4\frac{1}{2}$ IN. JOURNAL.

the cover rests between two projections on the box, and to open it it is pulled outwards to clear these projections, and is then pushed upwards or downwards. Both these arrangements have been used a great deal in this country. The machine-fitted front is, however, decidedly preferable, as the sheet iron cover seldom retains its shape well enough under service conditions to keep out dust or prevent undue spilling of oil, and is, moreover, easily torn off.

The bottom of the box below the level of the openings forms an oil well, and in English practice there is usually a lip round the box, just below the level of the openings. The journal is lubricated either by means of oil-soaked waste with which the box is packed, or preferably by means of a cotton wick carried on a wire frame made to fit roughly the round exposed part of the journal, and pressed up by light



TRUCKS

springs. This latter arrangement is the one generally adopted in this country, and gives very satisfactory results. The box is provided with machined facings for the brass or for the keep, which is placed between the box and the brass, as the case may be, at the top and the upper part of the sides. The axle-box originally employed on the trailer bogies of the Central London Railway, shown in Fig. 422, is typical of English practice, being a modification, to suit the smaller size of journals, from those of the Great Western Railway. American practice is illustrated by the standard Master Car-builders' axle-box for a 4½-in. × 8-in. journal, shown in Fig. 423.

Both types are found quite satisfactory for steam railway service where the passenger stock can be overhauled in detail at the end of each run, and the goods stock usually runs at a low speed, and has a very low yearly mileage. For electric railway conditions, however, where rolling stock is in service for 16 or 20 hours a day for long consecutive periods, and may run several thousand miles without coming in for repairs, it takes a considerable time to attend to at the end of the day's work, even if spring lubricating wicks are used, and with waste packing things will evidently be much worse. On the Central London Railway a box with an internal removable oil well has lately been adopted with good results, and is now the standard arrangement on that railway. The well consists of a sheet tin tray in which is placed the spring frame carrying the lubricating wick. The opening in the front of the box extends to the bottom, so that the tray can be slid in and out, carrying the lubricating wick with it. The axle-box for this arrangement is shown in Fig. 422. With this arrangement, however, there is more leakage of oil than is desirable, especially on a tube railway, and a certain number of bogies have been fitted experimentally with the Korbully axle-box, which is very largely used on the Continent. This box is illustrated in Fig. 424. It is of an entirely different type from either the English or American standard patterns, and requires no packing or wicks. The whole axle-box practically forms one oil well, there being no opening at the front end, except a small hole at the top for renewing the supply of oil, and the back end being fitted with a leather packing, which is kept pressed against the journal by an adjustable steel band. The brass entirely surrounds the journal, and has an oil way at the bottom. This axle-box requires very little attention owing to the absence of packing, and will run without refilling for weeks at a time, effecting great economy in oil and improving the condition of the permanent way.

The clearance between the sides of the axle-boxes and the axle guards should not exceed $\frac{1}{16}$ in. in the longitudinal direction of the bogie, and should preferably be merely a slack fit. The same applies to the transverse travel if both outward and inward travel are limited on each box. In many cases only the outward travel is limited, each box being prevented from travelling inwards by the end thrust of the axle bringing the other box up against the opposite axle guard.

The standard bearing for both coach and wagon journals both in this country and America is a single bronze casting resting on the journal. With regard to material, standard practice is a copper-tin alloy, with small proportions of zinc and lead, the lead being added as a reducing agent for purely manufacturing reasons. The following would be a very suitable alloy—

Copper	80 to 88 per cent.
Tin	18 to 10
Zinc	2
Lead	0.5

ELECTRIC RAILWAY ENGINEERING

The standard American composition is—

Copper	80 per cent.
Tin	10
Lead	9.5
Phosphorus	0.5

Phosphorus, of course, has a similar reducing effect to zinc, besides hardening the alloy. Special alloys, such as Stone's bronze, are also largely employed, but the composition of these is naturally kept secret. Anti-friction metals of various compositions are also used a great deal. It does not appear, however, that there is any definite advantage in their use, unless, owing to special circumstances, the journals are of abnormal proportions; for instance, it may be necessary to use very short journals owing to restricted space, in which case the journal will have to be abnormally large in diameter, thus raising the journal speed, or the pressure per square inch will be abnormally high. With ordinary proportions, however, and with pressures limited to the figures already given, white-metal should be quite unnecessary as far as cool running is concerned, and the earlier chapters of this book will have made it clear that the proportion of energy employed in overcoming journal friction is quite small, whether the service be one of frequent stops and high acceleration, or few stops and high speed. If it is employed, it should be on bronze and not on a cast-iron backing, as the best of white metals will run occasionally, and the results to the journals will be disastrous, if the bearing has only a cast-iron backing. The brass usually embraces about one-third of the diameter of the journal. In some cases, the brasses on driving axles are brought further down at the sides to take up the motor thrust. There is no particular necessity for this, however, since the side thrust due to the motor must obviously be much less than that due to the brake block, which exists in the case of trailer cars also. The case is, of course, quite different from that of a steam locomotive journal, where the side thrust may often exceed the load on the journal. In any case the lower ends of the journal should be well rounded with a large radius, so as to avoid scraping the oil off the journal. The brass is usually bored from $\frac{1}{32}$ in. to $\frac{1}{16}$ in. slack on the diameter. In the writers' experience, the amount of slack should not exceed the smaller figure when both journal and brass are new.

In order to limit the end play of the journal in the brass, the latter usually rests between a shoulder on the inner end and a collar on the outer end of the journal; a certain amount of play is allowed between the two, the standard practice in America being to allow $\frac{1}{4}$ in. This is an excessive amount for a driving axle, since, for reasons that have already been given, it is undesirable to allow much end play where a motor is supported on the axle. A new brass should preferably be merely a slack fit, and should certainly not have more than $\frac{1}{16}$ in. play on the journal; this, of course, involves careful fitting in order to ensure that the brass bears properly on its whole surface and not merely on the shoulder of the journal. In some cases, where, in order to save room, the axle-box has to come very close up to the wheel, and the diameter of the axle where it passes through the box has to be kept down, the intermediate shoulder between the journal shoulder and the boss for the wheel centre is omitted, the axle being reduced in one step from the diameter in the wheel boss to the journal diameter. In this case, the end play of the journal is taken up either by bringing the end of the brass down over the end of the axle or by a separate end brass or keep, which is attached either to the brass or to the axle-box lid. This arrangement is usually only employed (1) on bogies which have to be got into an unusually small space, as in

TRUCKS

the case of the Central London and the Manhattan Elevated Railways, or (2) on bogies which, as in the case of the Lancashire and Yorkshire (Fig. 402) and the American Street Railways Association standard for 50-ton cars, Fig. 434, carry exceptionally heavy loads without being abnormally wide or requiring abnormally long or wide axle-boxes. When this arrangement is adopted, the whole of the end thrust is taken up on the end bearing of the axle. The brass is in this case fitted to the top and upper part of the sides of the axle-box, and its end play is limited either by a shoulder at its inner end or by a transverse leather engaging in a recess in the top of the box. The brass is sometimes provided with ribs, which are fitted to corresponding ribs in the box to avoid machining the whole surface. The standard arrangement of a journal with shoulders at each end will be found the better one on general grounds, and should not be abandoned unless there is some special reason, such as that given above. With shouldered journals, it is usual to have a packing piece termed a keep, or in America a wedge, between the brass and the axle-box. The object of the keep is to enable the brass to be removed with a smaller relative movement of axle and box than would otherwise be necessary for the brass to clear the collar. The collar being from $\frac{1}{2}$ in. to $\frac{3}{4}$ in. deep, the opening at the back of the box would be inconveniently large. The keep, however, is usually held from outward movement only by a small rib, so that by jacking up the box a short distance the keep can be removed and the brass lifted off the journal. In this country the top of the journal is usually a machined fit against the under-side of the keep, the sides of the journal and the top of the keep having machined ribs fitting against corresponding ribs on the sides and top of the axle-box. In America they are usually left rough, and either the back of the keep or the back of the journal is rounded so as to give a self-aligning bearing. The rounded keep is the more modern plan and the standard practice of the Master Car-builders' Association. A certain amount of slack has to be allowed between the keep and brass and the axle-box. For motor bogies, the total play of the brass in the box should not exceed $\frac{1}{16}$ in. With a clearance of $\frac{1}{16}$ in. for the brass on the journal and $\frac{1}{16}$ in. for the box in the axle guards, there will be a total of $\frac{3}{16}$ -in. end play on the axle. This should be looked on as an outside figure for a bogie leaving the shop; and, as already stated, the writers much prefer merely slack fits throughout. The total end play of the axle should be sufficient, however, to ensure that there is no binding in either longitudinal or transverse direction.

Table CXXI. gives the journal pressures in use with various axles in pounds per square inch of the projected area of the journal. It will be noticed that from 200 to 250 lbs. per square inch is about the usual pressure, and in this country similar pressures are also employed in locomotive work. American locomotive practice, however, is much more conservative. Meyer ("Modern Locomotive Construction") gives it as his opinion that the pressure should be kept considerably below 160 lbs. per square inch, if the journal speed exceeds 9 ft. per second, which, with ordinary proportions of wheels and axles, would correspond to a train speed of about 60 miles per hour. Probably the difference is due to the much greater care taken in fitting journals and brasses in this country. For high speed electric service, owing to the comparatively small wheels, journal speeds will generally be exceptionally high, and in such cases 200 lbs. should be considered the limit, but for urban services at, say, 15 or 20 miles an hour average speed, 250 lbs. is quite safe with proper workmanship and reasonable supervision.

With regard to axles, long experience has determined certain dimensions and maximum working stresses as desirable in the interests of safety and economy, and it

ELECTRIC RAILWAY ENGINEERING

can seldom be advisable to depart from these. Indeed, the tendency is all in the direction of increasing axle diameters for a given load, since it is found that, owing to the dead weight of the motors, the axles are subjected to almost as severe shocks as those of steam locomotives. Table CXXI. gives some comparative figures of the standard

TABLE CXXI.

Journal Pressures.

Axle	Fig.	Load on Journal in Pounds.	Dimensions in Inches (Fig. 435).				Projected Area of Journal, Square Inches	Journal Pressure in Pounds per Square Inch of Projected Area.	Bending Stresses in Wheel Seats, Pounds per Square Inch.	Remark.	
			A.	B.	C.	D.					
English standard for private owners' wagons	10-ton wagon	425	8,400	8	3.75	9.80	5.25	30	280	5,700	Car weight including load and equipment.
	15-ton "	426	12,000	9	4.50	10.00	5.75	40.5	296	6,400	
	20-ton "	427	16,000	10	5.00	10.00	6.75	50	320	5,300	
American M.C.B. standard	10,000-lb. car	428	7,700	7	3.75	8.50	4.875	26.2	294	5,700	
	60,000-lb. "	429	10,500	8	4.25	8.50	5.375	34	310	5,800	
American Street Railways Association standard	15-ton electric car	430	3,400	6	3.25	8.125	3.75	19.5	175	5,200	
	20 to 28-ton electric car	431	6,560	7	4.00	9.50	5.125	28	234	4,700	
	30-ton electric car	432	7,000	8	4.25	9.625	5.375	34	206	4,500	
	40-ton electric car	433	9,400	9	5.00	10.125	6.375	45	210	3,700	
	50-ton electric car	434	12,000	9.25	5.50	8.50	6.50	51	235	3,700	
Central London Railway motor axle	7,800	8	4.625	8.00	5.75	37	210	3,300	
Manhattan Electric Railway motor axle	6,800	8	4.25	8.50	5.50	34	200	3,500	

axles adopted by the English railway companies for private owners' wagons, by the Master Car-builders' Association of America for freight cars, and by the American Street Railways Association for electric cars. The Table also contains a few examples of axles actually in use on electric cars. These axles are also shown in Figs. 425 to 435. In order to obtain a uniform basis for comparison in computing the bending stresses, the load is assumed distributed along the whole of the brass, the wheel flanges assumed to be equidistant from the inside of the rails, and the distance between points of contact of wheels and rails assumed to be 4 ft. 10 ins., owing to the coning of the wheels and the radius of the rail table (see Fig. 435). Comparing the conditions under which motor-driven and trailer axles have to operate, it may be pointed out that whereas the bending moment of a trailer axle is a maximum at the points vertically over the points of contact of wheels and rails,¹ and is uniform between those points, the bending moment in a motor-driven axle is usually slightly greater at a point between the wheel centres, namely in one of the motor supporting bearings

¹ Neglecting the weight of the axle itself.

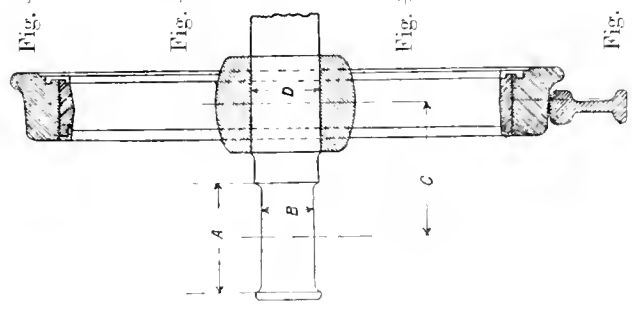
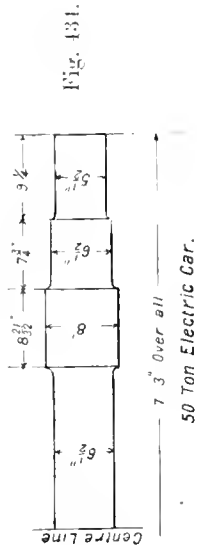
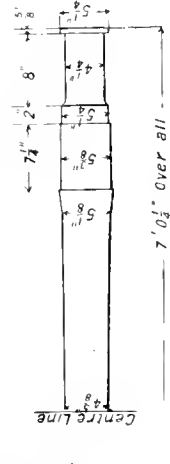
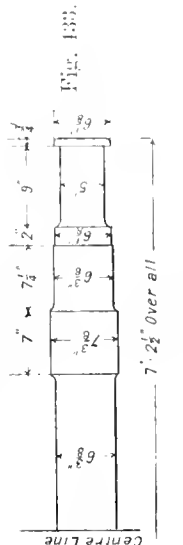
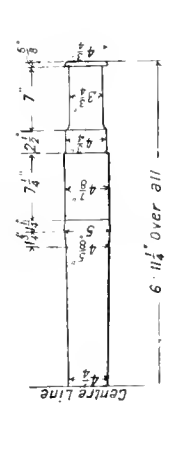
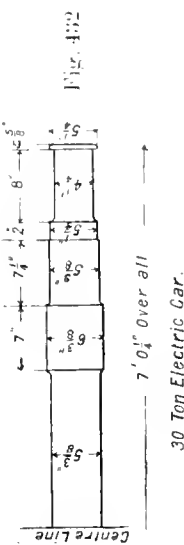
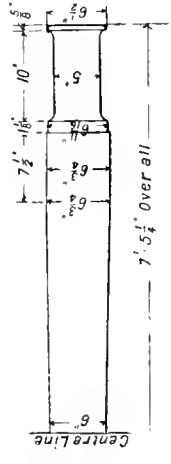
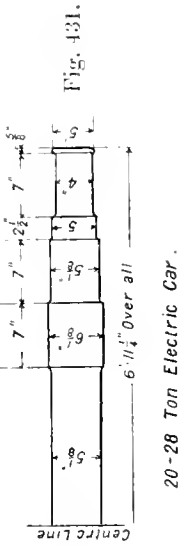
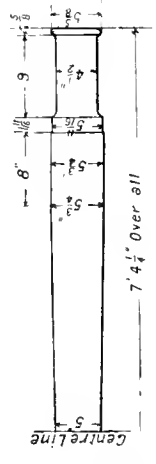
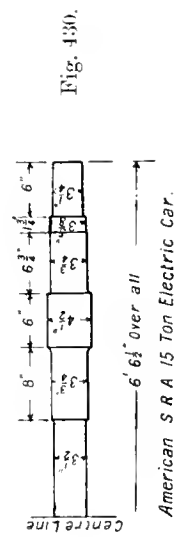
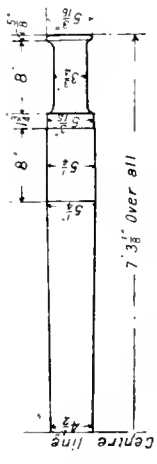

Figs. 425-435. CAR AND WAGON AXLES.

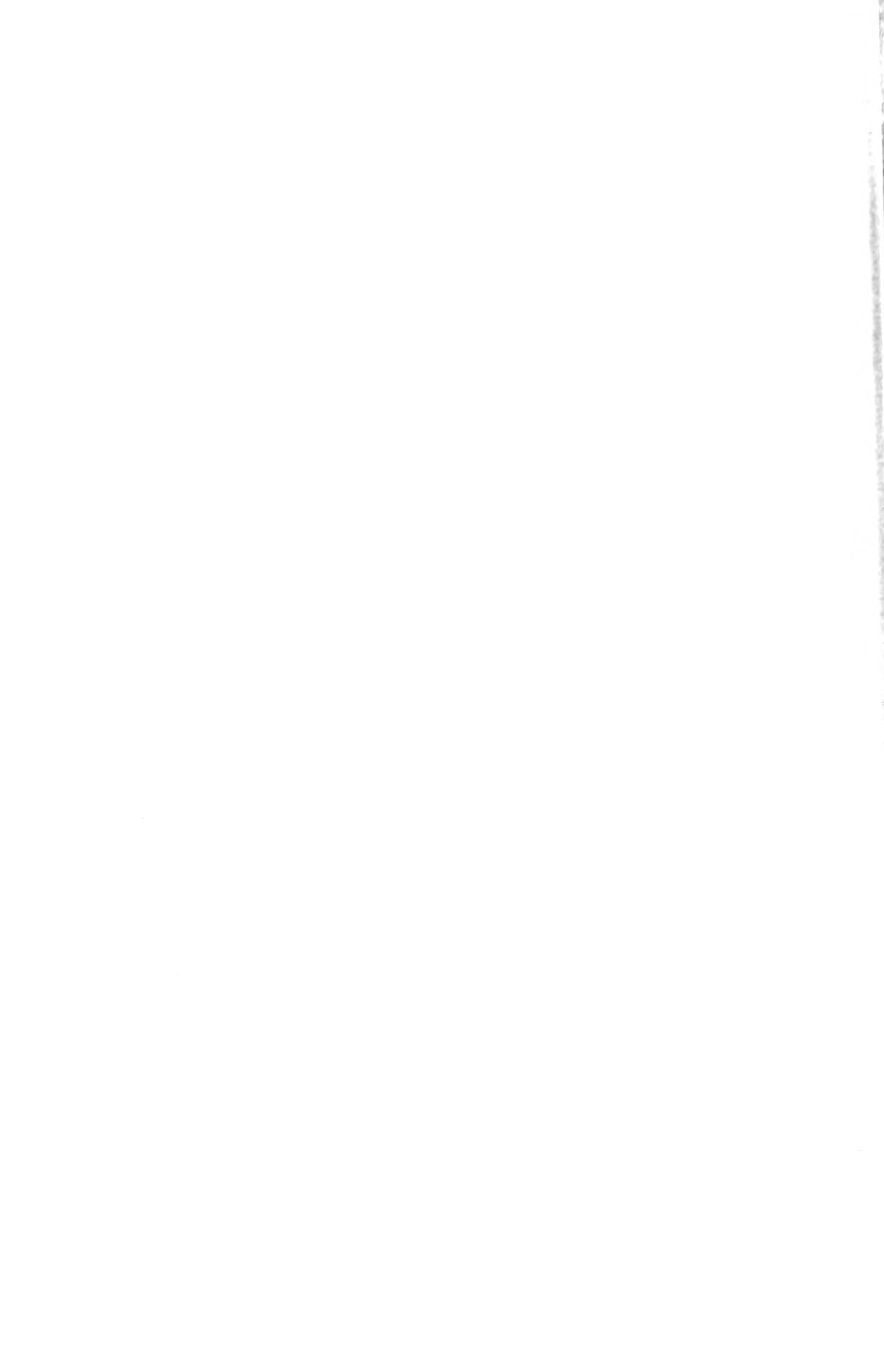

TRUCKS

(with a geared motor), or in the spider of the armature if carried on the axle. The stresses to which the trailer axle is subjected are bending moment and shear due to

- (1) The load;
- (2) The pressure of the brake block when brakes are set (with single blocks);
- (3) The backward thrust of the axle when brakes are set. They are subjected to torsion due to—

- (4) Unequal travel of the wheels on curves.

Of these stresses (2) is fixed by the wheel load as described in dealing with brakes, and (3) and (4) are obviously limited by the wheel load and the coefficient of adhesion of wheel and rail. With regard to (1), since certain parts—equalisers, axle-boxes and fittings, and the axle itself—are not carried on springs, they will from time to time apply forces equal to several times their weight, the greater part—the weight of the axle—being between the wheel hubs.

The additional stresses to which a motor-driven axle is subjected are—

- (5) Bending moment and shear due to the forward thrust of the motor drive;
- (6) Torsion due to the motor drive.

Both these again are limited by the wheel load and the coefficient of adhesion to the same values as (2) and (3), so that *for a given load* the driving axle will, as far as they are concerned, have no more to stand than a trailing axle. Here again the conditions of a motor-driven axle are quite different from those of a steam locomotive driving axle. In nearly all cases, however, the stresses due to (1) are much higher in the driving axle than in the trailing axle, since the unsprung-borne load will, in the majority of cases, be a much larger proportion of the whole. If the motor is gearless, the armature almost always, and the field magnets in many cases, are not spring-supported, while with geared motors there are usually bearings on the axle to keep the gears properly meshed. In either case a force equal to several times the weight of the motor will be momentarily applied from time to time.

It is important to bear in mind that the *maximum* bending stresses will be much larger than those given in the table. For instance, in passing round a curve the flange of the wheel pressing outwards will increase the distance C , and the load on the outer journal, besides causing additional bending due to the thrust on the wheel. Worn wheels and rails will also increase the distance C , a badly fitted brass may concentrate the load towards the outer end of the journal, whilst comparatively small irregularities in the road may easily double the load on the journal. The side thrust due to the brake block has already been dealt with.

It therefore becomes necessary to design motor driving axles considerably more liberally than trailing axles for the same load. A further reason which necessitates liberal design is the existence of keyways for securing the armature or gear wheel, as the case may be, to the axle. The actual reduction of strength for a static load caused by this is inconsiderable, but, as is well known, cracks are always liable to start from the corners of holes and keyways in shafts or axles. This consideration is of such importance that the Committee on Standards of the American Street Railways Association, in their report in 1902—which was adopted by the Association—recommended that the axles should be so much enlarged at the gear wheel fit that the distance from the axis of the axle to the bottom of the keyway should be the same as the radius of the axle in the driving wheel hub. This appears to the authors to be somewhat unnecessarily large, and results in an objectionable shoulder immediately inside the wheel hub, but there is no doubt that the recommendation, since it errs on the side of strength, errs in the right direction.

ELECTRIC RAILWAY ENGINEERING

The disadvantages of having keyways to the axle have led to the introduction of several devices to render them unnecessary. The best known is probably that of Messrs. Doyle and Brinckerhoff, which was adopted on the Metropolitan West Side and the Manhattan Elevated Railways, where a solid gear wheel is shrunk on to an extension of the driving wheel hub, as shown in Fig. 436. This method, of course, has the obvious drawback that, in order to remove the gear wheel, the driving wheel has to be removed from the axle. This might be got over by using a split gear keyed on to the extended hub, but, with the large hub necessitated by this arrangement, it would be difficult, if not impossible, to find room for the bolts for holding together the split gear wheel.

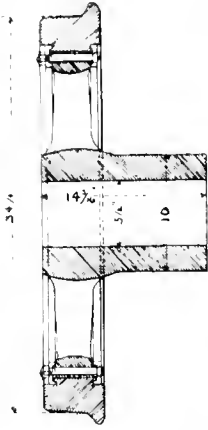

Fig. 436. MANHATTAN WHEEL.

With regard to material, the sizes of axles adopted by the Master Car-builders' Association are intended for either wrought iron or mild steel. Mild steel is practically universal for electric traction purposes, the most suitable material having an elastic limit of about 20 tons and an ultimate tensile strength of 33 to 38 tons per square inch, with not less than 40 per cent. reduction of area at fracture and 25 per cent. elongation in a 2-in. length. The rough axle should stand, without breaking, sixteen blows from a 1-ton tup, falling 25 ft. on the centre of the axle, the latter resting on supports 3 ft. 9 ins. or 4 ft. apart, the axle to be turned after each blow. Two per cent. of each batch of axles should be thus tested.

Cast steel has been employed with some success for locomotive crank axles, but there appears to be nothing to be gained by its use for straight axles. Table CXXII. gives a list of various qualities of steel for axles. Nos. 1, 2, and 6, are specification figures, and the remainder are test figures. Nos. 2 and 3 are respectively the specification and test figures for the nickel steel in use in certain of the Central London motor axles.

TABLE CXXII.

Various Qualities of Steel for Axles.

Number.	Maker and Description.	Elastic Limit, Tons per Square Inch.	Breaking Strain, Tons per Square Inch.	Elongation, per cent.	Reduction of Area, per cent.
1	Manhattan Elevated Railway, motor axle	Not less than 17.9	35.7	—	—
2	Krupp, Siemens-Martin	—	28	30	
3	Krupp, 80-ft. nickel steel	24	32	30	
4	" " " "	24.13	33.3	41	65
5	J. Baker & Co		36	27	53
6	S. Fox & Co.		36	29	51

For attaching wheels, whether driving wheels or otherwise, to axles, the authors have always found a press fit without keys to be quite satisfactory. As the axles do not have to transmit such severe torsional shocks as those of steam locomotives, keys are usually unnecessary, and it is an obvious advantage to avoid the use of keyways in

TRUCKS

the driving axle where possible. On the Central London Railway the wheels, which are 34 ins. in diameter, are pressed on to the axles, which are $5\frac{3}{4}$ ins. in diameter in the wheel fit, with a pressure of not less than 50 tons or more than 60 tons. The tractive force exerted by the motor at full rated load is about 3,200 lbs. at 17-in. radius, and the sharpest curve on which these trains run is 150-ft. radius. A good general rule when keys are not employed is to allow 10 tons pressure for every inch of axle diameter in the wheel seat.

With regard to wheel centres, there appears to be little to choose between wrought iron and soft cast steel. The former material is perhaps more generally employed, but a cast steel of about 28 to 32 tons per square inch ultimate tensile strength and a minimum elongation of 15 per cent. in a 2-in. length is found to give good results in locomotive practice, and should therefore be quite satisfactory for electric traction, especially as the castings are somewhat simpler in form. It must be borne in mind in dealing with wheel centres generally that the wheels of electrically driven vehicles, like the axles, are subject to heavy shocks due to the fact that a considerable proportion at least of the weight of the motor is carried direct on the axle. Where gearless motors are employed, with the entire weight of the motor carried without springs, considerable trouble has been experienced from time to time by failures of wheel centres, even where these were of exceptional strength judged merely by the load. For wheels other than driving wheels a wood centre is, of course, quite suitable, and possesses several advantages which need not be discussed here, as they are well known in ordinary railway practice. In tube railways they are particularly advantageous on the score of noise. Tyres are usually secured to the centres by a lip on the side of the wheel centre and by a locking ring, which should be shrunk on at a low heat. Fig. 437 shows the standard sections of tyres and fastening rings approved by English railway companies for private owners' wagons. In the case of driving wheels it is a common practice to omit the locking ring and secure the tyre by means of the lip and by studs screwed through the rim into the tyre from the inside. An example of this will be noticed in the Lancashire and Yorkshire bogie (Fig. 402). Another method, illustrated by No. 4 of Fig. 437, and also by the Manhattan driving wheel (Fig. 436), is to have two locking rings and secure these and the tyre to the centre by means of bolts parallel to the axle. The standard width and depth of railway tyres having been arrived at as the result of long experience, they should be adhered to unless there is some substantial reason for departing from them. The standard width of tyre in this country for coaches and wagons is 5 ins. For driving wheels it is desirable to follow steam locomotive practice and make the width $5\frac{1}{2}$ ins. or at least $5\frac{1}{4}$ ins., especially if, as will happen in many cases, the train is to be pushed from the rear, as well as pulled from the front. Narrow wheels are very objectionable, as they travel badly, cause undue wear at points and crossings, and, indeed, necessitate extreme care to avoid frequent derailments at these places. For tube railways, however, where, as has been pointed out above, the allowable wear on wheel treads is small, it is permissible to employ a thin tyre, as otherwise tyres will have to be replaced before they are rendered unserviceable by their thinness. In order to obtain the best material to ensure safe and economical running, it is necessary to consider carefully the type of service in which tyres are to be employed. For railways with numerous stops, which implies heavy wear due to braking, a hard tyre is desirable; and as speeds under this condition will be comparatively low, such tyres can be employed with safety, whereas, at very high speeds, an extremely hard tyre may be undesirable and will not be so necessary owing to the conditions of service. For

ELECTRIC RAILWAY ENGINEERING

tube railways, it is of particular importance that the hardest tyre consistent with safety be employed, since the allowable variation from the standard loading gauge is usually small, and the depth of wear on the tyres is consequently less than in ordinary practice. Several qualities of steel, recommended by various makers, are given in

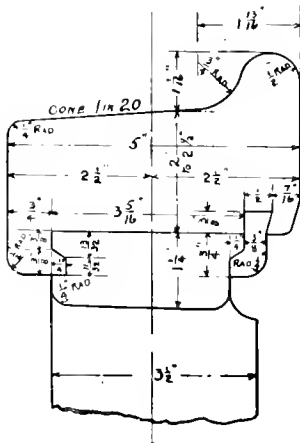

No. 1

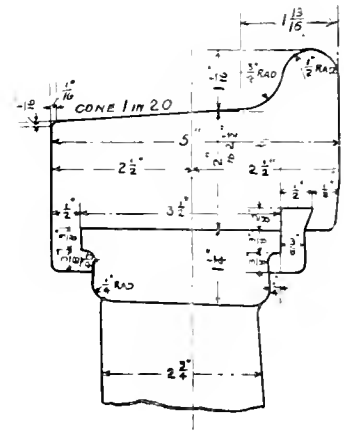

No. 2.

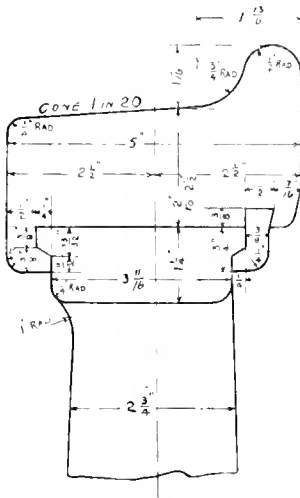

No. 3.

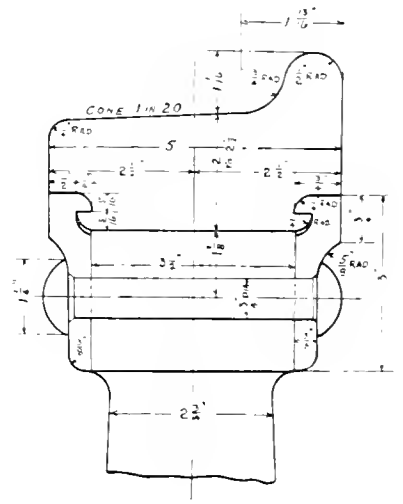

No. 4.

Fig. 437. TYRE SECTIONS Issued 1904).

Table CXXIII. Nos. 1 to 3 are specification figures: the remainder are from actual tests, Nos. 3 and 4 being respectively the specification figures and the test figures for the same steel. It has been found that for tube railway work a steel of No. 6 quality is far too soft, and even No. 5 necessitates frequent turning up of the wheels. On the



Index

- ACCELERATION, 21 *et seq.*
 Distribution of tractive effort amongst axles, 29
 Electrical Equipment Weight, 43
 Energy required for, 18
 "Motor Curve," 25, 32, 48, 62, 66
 Power,
 Amount required during, 31
 Ratio of maximum to average power at axles, 51
 Relation of maximum to average input to train, 80
 Schedule Speed Limitations, Method of Investigating, 34
 Series Motor Characteristic, 32
 Steam *versus* Electric Service, 29, 31, 51
 Variable rate of, effect on Rolling Stock and Permanent Way, 32
- Accumulators,
 Comparative Cost of Plant with and without, 200
 Use of in Sub-stations, 191
- Adhesive Coefficients, 326
- Air,
 Compressor, Motor-driven, 336
 Pumps, 112
 Edwards' type, 118
 Resistance, Relation to Total Resistance, 10
- Algemeine Elektrizitäts Gesellschaft,
 High Speed Motor Car used for Berlin-Zossen Tests, 362
 Winter-Eichberg type of Motors, 394
- Allen, A. H., on Central London Railway Sub-Stations, 212
- Alternating Current,
 Current Values in Track Rails, 286
 Equipments, *see* Electrical Equipments
 Generators, *see* Generators
 Motors, *see* Motors
 Resistance of Rails to, 280
- American Bogie Truck, 433
 Brake Foundation in Trailer Bogie, 446
- American Locomotive Co., Electric Locomotives for New York Central Railway, 292
- American Master Car-builders' Association,
 Axle-Box, 454
 Axles for Freight Cars, 458
 Material, 460
 Brake Heads and Shoes, 449
 Rounded Keep for Journal, 457
 Swing Bolster, 434
- American Society of Civil Engineers, Recommendations for Track Rails, 269
- American Street Railway Association,
 Axle-Box, 454
 Axles for Electric Cars, 458
 Standards Committee Recommendations, 459
 Motor Bogies, Play of Journal in Brass, 457
- Anderson, E. H., on Speed-time Curves, 53
- L.R.E.
- Armature,
 Effect on design of Fly-wheel, 161
 Magnetomotive Force, 176
 Method of Mounting on City and South London Locomotive, 315
 Rotational Energy of, 21, 418
 Type to be employed with Compound-wound Synchronous Motors, 175
- Armstrong, on
 Effect of frequent stops in high-speed rail-roading, 84
 High Schedule Speeds, 91
 Light *versus* Heavy Trains, Tractive Force required, 87
 Live Load Percentage, *Note* 13
 Some phases of the Rapid Transit Problem, 23
- Ashe, S. W.—Starting Converters, 205
- Ashe and Keiley on Ratio between dead and told Weight of Cars, 13
- Aspinall, on
 Air Resistance, 10
 Comparison between heavily loaded and light trains, *Note* 11
 Tractive Resistance, 4 *et seq.*
- Auxiliary Apparatus for New York Central Locomotive, 296
- Avery Weigher, 124
- Axle(s),
 Attachment of Wheels to, 460
 Boxes, 453
 Distribution of tractive effort amongst, 29
 Guards for Bogies, 435
 Maximum instantaneous Power required, 41, 49
 Power and Energy, Relation of to Tractive Force, 40
 Ratio of Maximum to Average Power, 51
 Recommendations of American Street Railway Association Standards Committee, 459
 Standard for Freight and Electric Cars, 458
 Steel, Various qualities for, 460
 Weight of Motor on, 451
- BABCOCK AND WILCOX Water-Tube Boilers, 129
 "Baggage Car" type of Paris-Orleans Electric Locomotive, 324
- Baker Street and Waterloo Railway,
 Conductor Rails, Method of Mounting and Insulating, 251
 Insulators, 250
- Baltimore and Ohio 1896 Gearless Locomotives,
 Data, 307
 Trucks, 431
- Baltimore and Ohio 1903 Geared Locomotives,
 310, 386
 Trucks, 431
- Barbier on Power absorbed by Locomotive compared with Train, *Note* 12

INDEX

- Barometric Condenser, 110
 Barrett, Brown and Hadfield—Test Results, 247, 248
 Basic Open-hearth Rails, 269
 Battery-Booster Set, 192
 Bearings—Standard Composition for Coach and Wagon Journals, 455
 Berlin-Zossen Tests, *5 et seq.*, 172, 362, 391
 Camp's Concise *Résumé* of, *Note 6*
 Bessemer Steel Rails, 269
 Blood's Formula, 87
 Board of Trade Regulations on,
 Earthed Conductors, 277, 284
 Supporting Suspension Cables, 259
 Voltage drop in uninsulated Conductors, 241
 Bogie Trucks, *see* Trucks
 Boilers, 107
 Mechanical Stokers *versus* Hand Firing, 109
 Bolsters, Swing and Rigid, 434
 Bolts, Inferiority of to Rivets, 440, 443
 Boosters,
 Compound-Wound in series with Battery, 192
 Track Arrangement for Alternating Current, 284
 Brakes),
 Foundation Work, 445, *et seq.*
 Heads, 449
 Shoes,
 Energy dissipated at during Retardation, 23, 48
 English and American types, 418
 Braking,
 Gradients, 81
 Rate of Retardation during, 23
 Regenerative Control methods of Restoring Energy, 46
 Brill Truck, 435, 441
 Bristol Tramways,
 Generating Plant, 115
 Plan of Power Station, 124
 Type and Capacity of Plant Installed, 126
 British Insulated and Helsby Cables, Ltd.,—
 Cables furnished to London Underground Electric Railways, 158, 161
 British Thomson-Houston Co.,
 Compensated Series Single-phase Motor, 396
 Overhead Conductor and Supports, 263
 Winter-Biehler type of Motors, 395
 British Westinghouse Co., *see* Westinghouse Co.
- CABLES.**
 Concentric—Standard Thickness of Insulation and Lead Sheathing, 162
 Three-Core,
 Construction,
 Central London Railway, 156
 District Railway, 158
 Metropolitan Railway, 161
 New York Subway, 154
 Engineering Standards Committees' Recommendations, 147
 Hendley's Patent "Laminc" Conductor Cable, 162
 High Tension Cable Joint, 160
 High Tension Transmission System, Cost and Construction, 110
 Installation, 142, 153
 Maximum Current Densities permissible in Copper Conductors, 148
- Cables, *contd.*
 Three-Core, *contd.*
 Paper *versus* Rubber Covered, 150
 Standard Thickness of Insulation and Lead Sheathing, 162
 Temperature Distribution in, 149
 Ferguson's Tests, 150
 Temperature Rise in, 148
 Twin—Standard Thickness of Insulation and Lead Sheathing, 162
 [*See also* Suspension Cables.]
 Callender's Cable and Construction Co.—Cables supplied for District Railway, 160
 Camp's W. M. *Résumé* of Berlin-Zossen Tests, *Note 6*
 Car Axles, 457
 Car Wheels—Ratio of Maximum to Average Energy at, 69
 Carbon,
 Effect on Conductivity of Steel, 247, 248
 Percentage of in Track Rails, 269
 Carriage Axle Boxes, 453
 Carter on,
 Adhesion Coefficient, 326
 Arrangement of Track Boosters, 284
 Energy Consumption, 80
 Kinetic Energy of Train due to Rotating parts, 21
 Location of Sub-Stations, 241
 Rated Capacity of Electrical Equipment, 84
 Rating of Railway Motors, 55
 Speed-time Curves, 53
 Tractive Resistance and Power required, 15
 Weights of Continuous Current Equipments, 88
 Weights of Single-phase and Continuous Current Motors, 389
 Cascade Control, 391
 Cascade Motor set of Valtellina Locomotive, 335, 337
 Central London Railway,
 Axles, 458
 Method of Attaching Wheels to, 461
 Bogie Truck, 438
 Arrangement of Contact Devices, 453
 Parshall's Design, 439
 Brake Arrangement, 441, 447, 450
 Play of Journal in Brass, 457
 Position, 452
 Brake Block, 449
 Cable Construction, 156
 Carriage Axle Box, 455
 Conductor Rails, Method of Mounting and Insulating, 251
 Crown Rail Bonds, 277
 Equipment Weight and Energy Consumption, 95
 Gearless Locomotives, Data, 317, 386
 G.E. 66A Motor, Employment of, 54
 Generating Plant, 101
 Cost and Comparison, 133
 Plan of Power Station, 115
 Type and Capacity of Plant Installed, 119
 Gradients, Energy supplied by, 18
 Insulators, 250
 Kinetic Energy of Armature, 448
 Latest Type of train, Motor Equipment, Data, *etc.*, 57
 Operation of, 61
 Speed, Tractive Force and Power Calculations, 68

INDEX

- Central London Railway, *contd.*
 Starting Resistance, 4
 Sub-Station, Technical Data, 208
 Comparative Costs of Rotaries and Motor Generators, 186
 Plan and Equipment, 212
 Tests,
 Rail Resistance to Alternating Currents, 281
 Tractive Resistance, 8, 66
 Tyres, 163
- Centrifugal *versus* Reciprocating Pumps, 111
- Chambers' Patent Third-Rail Insulator, 251
- Channel Rail, Use of, 251
- Characteristics of Electric Railway Motors, 54
- Chicago Rail Bond, 276
- Chimney—Height, Effect of on Draught, 108, 115
- City and South London Railway,
 Conductor Rails, Method of Mounting and Insulating, 251
 Curves, Tests showing effect of on Tractive Resistance, *Note* 11
 Gearless Motors, 315
 Starting Resistance Experiments, 4
 Tractive Resistance Tests, 8
 Trucks, 431
 Arrangement of Contact Devices on, 453
- Clark, D. K.—Formule for Designing Semi-Elliptical Springs for Locomotives, 44
- Clearing House Conference—Position of Conductor Rails, 255
- Coasting, 23
 Influence on Speed-time Curves, 76
 Reduction of Energy at Axles, 48
 Retardation due to Train Friction, 66
- Coefficients,
 Adhesive, Steam and Electric Locomotives, 326
 Weight Coefficient of Railway Motors, 373
- Columbia Rail Bond, 277
- Commutation in Single Phase Motors, 415, 421
- Commutator, Deterioration of—Single Phase *versus* Continuous Current Motors, 96
- Compensator,
 Connection of Three-phase Rotary with, 204
 Oil-Cooled Type, 402
- Compounding, Effect of a change in adjustment, 183
- Condensing Plant, Type and arrangement, 109
- Conductors,
 British Standard Sizes, 117
 Construction and Supports, 162
 Maximum permissible current densities, 148
 Overhead System, 245
 Suspension Cables, 260
 Voltage drop in uninsulated—Board of Trade Restrictions, 241
 [*See also* Rails, Conductor.]
- Conduit Construction—Single *versus* Multiple Ducts, 153
- Contact Devices,
 Arrangement on Bogie Trucks, 453
 New York Central Locomotive, 297
 Paris Orleans Locomotive, 323
- Continuous Current,
 Generators, *see* Generators
 Motors, *see* Motors
 Overhead System, 245
 Track Rails, 286
- Continuous Current *versus* Single Phase System, 95, 360, 386, 419
 Carter on, 242
 Comparative Capital and Operating Costs, 125
 Deterioration of Commutator, 97
- Contour of Train, Effect of on Resistance, 10, 13
- Control System, 63, 69
 Baltimore and Ohio 1903 Geared Locomotive, 311
 British Thomson-Houston Single Phase Railway System, 403
 British Westinghouse Single Phase Motors, 405
 Electro - pneumatically controlled Unit Switches, 411
 Cascade System, 335, 391
 Gradients *versus*, 81
 New York Central Electric Locomotive, 295
 Parallel *versus* Series Parallel, 74, 75
 Paris-Orleans Locomotive, 325
 Pneumatic Control Connections for Rheostat, 335
 Regenerative Control Methods of Restoring Energy, 46
 Regenerative *versus* Series Parallel, 47
 Rheostat Loss, 58
 Valtellina Motor Cars, 343
 Ward-Leonard System, 351
- Converters, *see* Rotary Converters
- Cook, E. E., Trucks for District Railway, 439
- Cooling,
 Curve, 82
 Towers, 114
 Type of Condenser, 110
- Copper,
 Cost, 142
 Losses, 82
- Costs,
 Capital and Operating for Continuous Current *versus* Single Phase Railway Systems, 425
 Geared *versus* Gearless Equipments, 372
 Crane used on Central London Railway, 212
 Crown Rail Bond, 277
 Cserhati—Regenerative features at Valtellina, 338
 Current Density in Track Rails, 286
 Curtis Turbine Generator for operating New York Central Locomotive for tests, 298
- Curves,
 Comparison between Carter's and Armstrong's, 85
 Effect of on tractive resistance, 11, 13
- Dawson on Weights of Single Phase and Continuous Current Equipments, 388
- Dielectric,
 O'Gorman's principle of Grading, 143
 Standard thickness, 164
 Strength of Cable insulated with Varnished Cambic, 141
- Distributing System, 244
 Protection of Live Rails, 251
 [*See also* Third Rail and Overhead Systems.]
- District, Metropolitan, Railway, *see* London Underground Electric Railways
- Diversity Factor, 69
- Draught — Chimney, Draught produced by, dependent upon height and temperature of gases, 108, 115
- Drifting, *see* Coasting

INDEX

- Driving Wheel Diameter, 372
 Doulton's Insulators, 250
 Doyle and Brinckerhoff's Keyless Driving Wheel, 460, 461
 Dublin United Tramways,
 Generating Plant, 115
 Cost and Comparison, 133
 Plan of Power Station, 127
 Type and Capacity of Plant installed, 130
 Ducts, 153
 Dudley, Dr. P. H., on
 Influence of rail on tractive resistance, *Note 5*
 Power absorbed by locomotive compared with train, *Note 12*
 Dynamos, *see* Generators
- EARLE, Mr. — Cost of Cables, 187
 Earthed Conductors, Board of Trade Regulations, 277, 284
 Eastern Railway of France, *Note 12*.
 Ecole d'Electricité, Tests of Rail Bond Resistances, 279
 Edwards' Air Pump, 118
 Efficiencies,
 Continuous Current and Single Phase Motors, 415 *et seq.*
 English and Foreign Power Stations, 134
 Thermal Efficiency of Power Station Plants, 136
 Eichberg, Development of Single-phase Commutator Motors, 393, 394
 Electric
 Cars—Motor Axles, 458
 Locomotives, *see* Locomotives
 Motors, *see* Motors
 Railway Service—Axle-box, type of, 455
 Traction *versus* Steam Traction, 13, 29, 34, 51, 88, 325
 New York Central Railway Tests, 301
 Valtellina Railway, 344
 Electrical Equipment,
 Carter's Curve of Rated capacity of, 84
 Contact Devices, 297, 453
 Gearless *versus* Geared, Relative weights and costs, 372
 Locomotives and Motor Carriages, 291
 Overhead System, 245
 Single-phase *versus* Continuous Current Systems, 97, 388, 422
 Weight, 29, 31, 43
 Baltimore and Ohio 1903 Geared Locomotive, 314, 386
 Central London Gearless Locomotive, 319, 386
 Central London Railway, Percentage to total train weight, 95
 New York Central Locomotive, 293, 386
 Paris-Orleans Geared Electric Locomotive, 323, 386
 Siemens and Halske high speed 10,000 volt three-phase Locomotive, 357
 Weight including Continuous Current Motors and Accessories, Carter's data, 88, 94
 [*See also* Locomotives and Motors.]
 Electrical Power Generating Plant, 101 *et seq.*
 [*See also* Generating Plant.]
 Elliott Bros., Leakage Indicators, 222
 Elliptical and Semi-elliptical Springs, 444
- Energy,
 Amount dissipated at Brake Shoes during retardation, 23
 Consumption,
 Axles, 40
 Central London Railway, 95
 Influence of Gradients, 80
 Employed in overcoming journal friction, 456
 Ratio of maximum to average energy at car wheels, 69
 Recoverable,
 Gradients, 81
 Percentage of, 47
 Regenerative Braking, 46
 Reducing, Methods of, 23, 48
 Rotational Energy of Armature, 21, 448
 Supplying, Methods of, 18
 Engineering Conference—Position of Conductor Rails, 255
 Engineering Standards Committee,
 Insulation and lead sheathing for three-core and Concentric Cables, 162
 Stranded Conductors, 147
 Track Rails, 270
 Equalising Lever, 432
 Evaporation, Heat transferred from water to air by, 114
- FARES, Difficulty of adjusting, 90
 Furman Co. of Chicago, Type of "under contact" third rail, 254
 Ferguson, L. A., on
 Conduit Construction, 153
 Temperature distribution in Cables, 150
 Field Excitation,
 Effect of re-arrangement, 185
 Series Motors, 54
 Field Magnetomotive Force, 176
 Finzi, Compensated Series Single-phase Commutator Motor, 395, 422
 Fly Wheel, 103
 Forest City Electrical Co., "Protected" rail bonds, 275
 Frame Design, Weaknesses, 442
 Freight Service,
 Freight weight, percentage of total train weight, 12
 Standard Motor Axles, 458
 Friction,
 Journal, Energy employed in overcoming, 456
 Losses, *see* Losses.
 Train, 66
 Fuel, Thermal value, 108
 Furnace temperature, 107
- GANZ & Co.,
 Italian State Railways, Polyphase Locomotive 1906 type, 341
 Valtellina three-phase gearless locomotive, 326
 Gear Ratio, Effect on speed and tractive effort, 82
 Geared *versus* Gearless locomotives, 315, 325
 [*See also* Locomotives.]
 Gearing Losses, 55
 Geipel Steam Traps, 126
 General Electric Co. of America,
 Method of protecting live rail, 253

INDEX

- General Electric Co. of America, *contd.*
 Motors,
 Compensated series single-phase commutator
 motors, 395
 G. E. 66A motor, 51 *et seq.*
 G. E. 605 75 h.p. motor, 396
 New York Central Railway Electric Locomo-
 tive, 292
 Tests, 298
 Rail Bonds, 274
 Resistance and Composition of Steel, Test
 results, 247
 Generating Plant,
 Arrangement, design and characteristics, 101
et seq.
 Capacity, 243
 Condensing Plant, arrangement and type, 109
 Cost of operating and maintaining, 152
 Generator, Conditions to be fulfilled by Con-
 tinuous Current and Alternating Current
 type, 104
 Mechanical Stokers *versus* hand firing, 109
 Turbines *versus* high speed reciprocating
 engines, 101, 103, 113
 Generating System, *see* Generating Plant and
 Power Stations
 Generators,
 Alternating and Continuous Current type, 104
 Specification for,
 550 k.w. vertical cross compound Continuous
 Current Steam Generator, 104
 2,500 k.w. vertical three cylinder compound
 three-phase steam generator, 105
 Synchronous *versus* Induction motors, 173
 Voltage calculation, 180
 [See also Motor Generators.]
 German Society of Electricians—Current Densities
 permissible in Copper Conductors, 149
 Glasgow Corporation Tramways,
 Generating Plant, 115
 Cost and Comparison, 133
 Plan of Power Station, 120
 Type and Capacity of Plant installed, 122
 Gottshall, W. C., on
 Tractive Resistance, 7
 Reduction, *Note* 11
 Increase of as a function of speed, *Note* 24
 Gradients,
 Braking on, 81
 Energy supplied by, 48
 Influence on
 Speed-time curves, 76, 80
 Tractive Resistance, 13
 Great Northern and City Railway—G. E. 66A
 Motor, 51
 Great Western Railway,
 Carriage Axle-box, 455
 Chambers' Insulator, 251
 Trucks with helical axle-box Springs, 433
 Grindle on Storage battery prices, 201
- HALPIN, DRUITT—Comparison of power absorbed
 by locomotive and tram, *Note* 12
 Hand firing *versus* Mechanical Stokers, 109
 Hay, H. A.,
 Motor bogie design, 435
 Braking, 459
 Hay, H. A., *contd.*
 Motor bogie design, *contd.*
 Play of Journal in Brass, 457
 Tyre, 461
 Heat transferred from water to air by radiation
 and evaporation, 114
 Heating, 82
 Cables, Heating of, 148
 Surface, 107
 Hedley's Motor Truck, 441
 Brake foundation, 447, 450
 Helical Springs, Formule for, 445
 Henley's Patent "Lumina" Conductor Cable, 162
 Heyland—Investigations on Polyphase Induction
 Motors, 392
 High Speed Electric Traction, Gearless loco-
 motive especially adapted to, 325
 High Tension Transmission System, *see* Trans-
 mission System
 High Voltage Continuous Current Motors, 386
 Highfield, Data on Storage Battery Prices, 201
 Hubbard's Booster-Battery Connections, 195
 Hunt Automatic Shovel, 124
- IMPEDANCE of overhead circuit with rail return
 283
 Induction Motors, *see* Motors
 Input to train, Relation of maximum to average,
 80
 Installation of Cables, 142, 153
 Institution of Electrical Engineers—Maximum
 permissible current in Copper Conductors, 148
 Insulating Conductor Rails, 248, 251
 Insulation on Cables, 141
 Paper *versus* Rubber, 150
 Standard thicknesses, 162
 Insulators,
 Cable, Suspension Cables, 260
 Rail,
 Chambers' Type, 251
 Material used, 249
 Reconstructed Granite Co.'s type, 251
 Interborough Rapid Transit Co., *see* New York
 Subway
 Iron,
 Brake Shoes of cold blast cast iron, 150
 Losses, 82
 Resistance, 246
 Italian State Railways,
 Ganz (1906) polyphase locomotives, 341
 [See also Valtellina Railway.]
- JET Condenser, 110
 Journals,
 Composition of bearings for coach and wagon
 journals, 455
 Friction, Energy to be employed in overcoming,
 456
 Play in Brass, 456
 Pressures, 457
- KAVANAGH, A. L., on current densities in Cables,
 149
 Kinetic Energy, 21, 80, 448
 Korbally Axle Box, 455

INDEX

- "LAMINE" Conductor Cable, Henley's Patent, 162
- Lammie, B. G., on
 Compensated Series Single-phase Commutator Motor, 395
 Single-phase railway system, 393, *Note* 415, 420, 421
- Lancashire and Yorkshire Railway,
 Bogie Truck for Electric Motor Cars, 435
 Arrangement of Contact Devices, 453
 Braking, 450
 Method of securing Tyre, 461
 Play of journal in brass, 457
 Experiments showing power absorbed by locomotive compared with train, 12
- Lancashire Boilers, 167
- Langdon, W. E., on position of conductor rails, 255
- Langen Mono-rail System, 367
- Latour—Development of single-phase commutator motors, 392-4
- Lead Sheathing, 143, 162
 Standard thickness, 164
- Leakage,
 Indicators, 222
 Truck Rails, Leakage from, 285
- Lincoln, P. M., on
 Single-phase system, 420
 Single-phase *versus* Continuous Current Equipments, 422 *et seq.*
- Live Rails, Protection of, 251
- Liverpool Overhead Railway—Tests showing accelerating rate, Mr. Mordey on, 31
- Load,
 Characteristics,
 Choice of motor and gear ratio, 82
 Fluctuation, 81
 Curves, 54
- Locomotives and their electrical equipment, 294 *et seq.*
 Frames,
 Material, 432
 Types, 442
 Geared,
 Baltimore and Ohio 1903 Locomotive, 310, 386
 Trucks, 431
 Gearless *versus*, 315, 325
 Paris-Orleans type, data, 319, 386
 "Baggage Car" type, 324
 Gearless,
 Advantages associated with greater weight of, 326
 Baltimore and Ohio 1896 Locomotive, data, 307
 Trucks, 431
 Central London Railway, data, 317, 386
 Geared *versus*, 315, 325
 New York Central Railway, data, 292, 386
 Especially adapted to high speed electric traction, 325
 Tests, 298 *et seq.*
 Trucks, 432
 Valtellina polyphase, 326
 Italian State Railways—Ganz 1906 polyphase Locomotive, 341
 Motor Cars *versus*, 291, 341
 Oerlikon 15,000 volt, 15 cycle equipped with single-phase Commutator motors, 347
- Locomotives and their electrical equipment, *contd.*
 Siemens & Halske high speed 10,000 volt 3-phase, 354
 Single phase with Continuous Current Driving motors, 416
 Oerlikon type, 351
 Steam,
 Electric *versus* Steam, 325
 Equalisers, *Note* 432
 New York Central "999" type, 294
 [See also Electrical Equipment.]
- London, Brighton and South Coast Railway,
 Weight of Single-phase equipment, 390
 Winter-Eichberg Motors, 394
- London Underground Electric Railway,
 Conductor Rails, 246
 Insulators, 250
 Metropolitan District Railway,
 Brake heads and shoes, 439, 449
 Cable construction, 158
 Conductor rails, Position of, 255
 Contact devices on truck arrangement, 453
 Forest City Bonds, 276
 Sub-station—technical data, 298
 Plan and Equipment, 225
 Trailer and Motor Bogies, 439, 441
 Metropolitan Railway,
 Cable Construction, 161
 Conductor Rails, Position of, 255
 Sub-stations—technical data, 298
 Plan and Equipment, 223
 Weight of continuous current equipment, 390
- Long Island Railway, 255
- Losses, 55
 Copper and Iron calculations, 82
 Friction—dry *versus* wet air pumps, 112
 Line loss and regulation, 145
 Rheostatic,
 Effect of severity of service, 59
 Reduction by series parallel Control, 58
 Single-phase commutator motors, 415, 421
- Lynden, Lamar, on Storage Batteries, 195, 202
- MAGNETIC Circuit, Saturation of, 54
 Magnetomotive force, 176
 Manganese, Effect on conductivity of steel, 248
- Manhattan Elevated Railway,
 Insulators, 250
 Motor Truck, 437
 Axle, 458
 Brake arrangement, 447
 Journal play in brass, 457
 Keyless driving wheel, 460, 461
 Sub-station on expenses, 242
- Master Mechanics' Association—Standard axle-box, 454
- McDoble on Adhesion coefficient in steam and electric locomotives, 326
- McGuire Bogie Truck, 440
- McMahon, Mr. P. V., on
 Gearless Motors, 315
 Starting Resistance Experiments, 4
 Tractive Resistance Tests, 8
 Tests showing effect of curves on, *Note* 11
- Mechanical Resistance, Relation to total resistance, 10
- Mechanical Stokers *versus* hand firing, 109

INDEX

- Mersey Railway, Method of protecting live rails, 253
- Metropolitan Railway, *see* London Underground Electric Railways
- Meyer on journal pressures, 457
- Mono-rail traction systems, Rolling Stock for, 367
- Morley, W. M., on acceleration, 34
- Motor
- Carriages and their electrical equipment, 291
 - Cars,
 - A. E. G. High Speed Zossen, 362
 - Electric Locomotives *versus*, 291, 344
 - Siemens & Halske High Speed Zossen, 362
 - Valtellina Railway, 343
 - Characteristics,
 - Average profile of the line, 83
 - Electric Railway Motors, 54
 - Control, *see* Control System
 - Curve, Acceleration on, 25, 32, 48, 62, 66, 73
 - Generators,
 - Economic advantage of, 188
 - Oerlikon single-phase locomotive with continuous current driving motor, 351, 416
 - Rotary Converters *versus*, 173, 186, 189
 - Starting of Asynchronous motor generator sets, 208
 - Motor driven air compressor, 376
- Motors,
- Alternating Current,
 - Losses in transformers and potential regulators, 56
 - [*See also* Motors, Single-phase, Polyphase and Synchronous.]
 - Continuous Current,
 - Electrical equipment data, 88, 94
 - High voltage, employment of, 386
 - Losses in external resistances, 56
 - Schedule speed, 29
 - Series motor,
 - Characteristics, 32
 - G. E., 66A, 54 *et seq.*
 - Variation in design, 54
 - Weight Coefficient, 373
 - Geared *versus* gearless, 315, 432
 - Induction,
 - Employment for driving continuous current generators, 173
 - 10,000 volt three-phase motors for Siemens & Halske Locomotive, 355
 - Method of attaching to bogie, 451
 - New York Central Locomotive, Motor for, 291
 - Nose *versus* Centre of Gravity method of suspending, 451
 - Polyphase Induction, 391
 - Disadvantages, 392
 - Rating of Railway Motors, 55, 87
 - Single-Phase Commutator,
 - Compensated series type, 395
 - G. E. A., 605, 75 h.p. Motor, Description, 396
 - Component Losses, Summary, *Note* 421
 - Development, 390
 - Inferiority to Continuous Current Motor, 415
 - Latour-Winter-Eichberg type, 393, 394, 417, 418, 422
 - Oerlikon 15,000-volt, 15-cycle locomotive equipped with, 347
 - Repulsion type, 393
- Motors, *contd.*
- Single-phase and Continuous current, weight, 388
 - Size dependent upon gear ratio, diameter of wheels, etc., 82
 - Synchronous
 - Employment for driving Continuous current generators, 173
 - Phase characteristics, 174
 - Y-connected, 177
- Mounting of Conductor Rails, 248
- NATIONAL Conduit and Cable Co. of New York, Cables furnished to Central London Railway 156
- Current Densities, Conditions for three-core Cables, 149
- Neptune Rail Bond, 277
- New York Central and Hudson River Railroad, 5
- Conductor Rails, Under contact 3rd rail, 250, 254
 - Insulators, 250
 - Live load percentage, 43
 - Locomotive,
 - Electric, data, 292, 386
 - Especially adapted to high speed electric traction, 325
 - Tests, 298—Steam *versus* Electric, 301
 - Trucks, 432
 - Steam "999" type, 291
 - Steel Tower for supporting overhead portion of transmission line, 171
 - Sub-stations, technical data, 208
 - Plan and equipment, 232
- New York Subway
- Cable Construction, 151
 - Method of protecting live rails, 253
 - Sub-stations—Technical data, 208
 - Plan and equipment, 238
- North Eastern Railway,
- Bogie truck for electric motor cars, 451
 - Arrangement of Contact Devices, 453
 - Brake foundation, 447, 450
 - Goods locomotive frame, 433
 - Sub-stations—technical data, 208
 - Plan and equipment, 229
- OERLIKON Co.
- Motor Generator type of single phase locomotive with continuous current driving motors, 351, 416
 - Switch, Overhead high tension, 351
 - Track boosters, 284
 - 15,000 volt, 15 cycle locomotive with single phase Commutator motor, 347
- O'Gorman on Insulation on Cables, 142, 187
- Oil-cooled Compressor, 402
- Output—Single-phase *versus* continuous current motors, 417
- Overhead System, 258
- Alternating and continuous current systems, 245
 - Construction of conductor and supports, 162
 - Contact collecting Devices of New York Central locomotive, 297

INDEX

- Overhead System, *contd.*
 High Tension Lines.
 Calculation of, 164
 Steel Tower for supporting, 171
 Suspension Cables, 259
 Third Rail System *versus*, 244
- PANTOGRAPH TROLLEY, 414
 Paper *versus* Rubber Insulation, 150
 Parallel Control *versus* Series Parallel Control, 74
 Paris Metropolitan Motor Car with rigid wheel base, 430
 Paris-Orleans Railway,
 Geared Electric Locomotive, data, 319, 386
 "Baggage Car" type, 324
 Method of protecting live rails, 253
 Mounting and insulating conductor rails, 251
 Parry, E., on Distribution of Current Density, 285
 Parshall,
 Motor Bogie for Central London Railway, 439
 Brake arrangement, 441, 447, 450
 Switchgear, 243
 Passenger Weight, percentage of total train weight, 12
 Pennsylvania Railway, *see* Wilkesbarre and Hazelton Railroad
 Periodicity for Alternating Current, 416
 Permanent Way, Effect of high accelerating rates, 32, 90
 Perrine and Baum, 171
 Play of journal in brass, 456
 Pneumatic control connection of rheostat, 335
 Polyphase induction motors, *see* Motors
 Polyphase transmission systems with rotary converter sub-stations, 190
 Potential Regulators, Losses, 56
 Power,
 Amount required during acceleration, 50
 Axles, Power at, 40 *et seq.*
 Maximum instantaneous power required at axles, 14, 49
 Percentage absorbed by locomotive and train, 12
 Ratio of maximum to average power at axles—
 Steam *versus* electric service, 51
 Power factor of single-phase motors, 418, 422
 Power Station,
 Arrangement of Plant, 107
 Bristol Tramways, 115, 124
 Central London Railway, 115, 133
 Dublin United Tramways, 115, 127, 133
 Efficiencies of English and foreign, 134
 Glasgow Corporation Tramways, 115, 120, 133
 Ratio between maximum and average input to train, Effect on, 80
 Thermal efficiencies of Plant, 136
 10,000 k.w. turbine station, 130
 Pressures, Journal, 457
 Profile of the Line, 83
 Pumps,
 Air,
 Dry and wet, 112
 Edwards' type, 118
 Centrifugal *versus* reciprocating, 114
- RADIATION—Heat transferred from water to air by, 114
- Rail,
 Bonds, 273
 Resistance data, 279
 Soldered, 278
 Insulators, *see* Insulators
 Rails,
 Conductor, 246
 Channel Rail, 251
 Data for various railways, 249
 Mounting and insulating, 248
 Overhead System, 258
 Position, 251
 Protection of live rails, 251
 Resistance to alternating currents, 280
 Under-contact type, 254, 302
 Track,
 Basic open-hearth, 269
 Bessemer steel rails, 269
 Bull-head rail, Standardization, 270
 Composition and Conductivity, 245, 267
 Conductor Rails *versus*, 246
 Leakage from, 285
 Resistance tests, 270
 [*See also* Third Rail System.]
 Raiton and Campbell Filters, 126
 Railways,
 Steam *versus* Electric, 13, 20, 34, 51, 88
 [*See also* Names of Railways.]
 Rankin's Formulae for design of helical springs, 445
 Rating of railway motors, 55, 87
 Reciprocating Engines *versus* steam turbines, 101, 103, 113
 Reciprocating *versus* centrifugal pumps, 111
 Reconstructed Granite Co.'s types of Insulator, 251
 Regenerative Control System, *see* Control System
 Regenerative features observed at Valtellina, 338
 Reichel—Advocate of continuous current motors, *Note* 392
 Repulsion type of single-phase commutator motors, 393
 Resistance,
 Air—Relation to total, 10
 Liquid starting, 74
 Loss in external resistance, 56
 Rail, 246
 Alternating Currents, resistance of rails to, 280
 Tests, 270
 Rail bonds, data, 279
 Tractive, 61
 Air and mechanical components, 10
 Aspinall on, 4 *et seq.*
 Berlin-Zossen tests, 5 *et seq.*
 Camp's *Resumé*, *Note* 6
 Comparison between heavily loaded and light trains, 11
 Curves, Influence on, 11, 13
 Energy required to overcome, 18
 Gradients, Influence on, 13
 Influence of uncontrollable factors, 3, 5, 13
 Internal and external, 63
 Reduction of, 10
 Starting resistance, 4
 Tractive resistance at constant speed, 3

INDEX

- Retardation, Rate during braking, 23
- Rheostatic Losses, *see* Losses
- Rheostats, Metallic and Water—Pneumatic control connections for Valtellina "1904" locomotive, 335
- Rivets, 110, 113
- Rolling Stock,
 - Acceleration, Effect of high rate on, 32
 - Data for various railway coaches, 14
 - Mono Rail Traction Systems, 367
 - Trucks, 430 *et seq.*
 - Valtellina Railway, 343
- Rotary Converters,
 - Central London Railway, 217
 - Comparative Costs, 189
 - Line Loss and regulation, 145
 - Motor Generators *versus*, 173
 - Central London Railway sub-station, 186
 - Phase characteristics, 177
 - Series winding, 186
 - Shunt excited, 184
 - Six-phase, 177
 - Employment, 172
 - Synchronising and switching, 206
 - Starting and synchronising of, 204
 - Three-phase,
 - Connection with compensator, 204
 - Magnetomotive force of armatures, 177
 - Synchronising and switching, 206
- Rubber *versus* Paper Insulation, 159
- SAMUELSON'S three-phase switch, 216
- Saturation of magnetic circuit, 54
- Schedule speed, *see* Speed.
- Schoepf—Weights of continuous current and single-phase motor equipments, 389, 390
- Series parallel control, *see* Control System
- Shawmut Soldered Rail Bonds, 278
- Shunt excitation—Effect of operating the rotary converter with, 184
- Siemens on Contour of Car, *Note 11*
- Siemens Bros., City and South London Gearless Locomotive, 317
- Siemens & Halske,
 - High Speed Zossen Motor Car, 362
 - High Speed 10,000-volt 3-phase locomotive, 354
- Single Phase Commutator Motors, *see* Motors
- Single Phase and Continuous Current System, 95, 360, 386, 419
 - Carter on, 242
 - Comparative capital and operating costs, 425
 - Deterioration of commutator, 97
- Smith, W. M., on Comparison of power absorbed by locomotive and train, *Note 12*
- Soldered rail bonds, 278
- Speed
 - Average speed, 28, *Note 91*
 - Effect of gear ratio on, 82
 - Schedule speed,
 - Continuous current motors, 29
 - Designation, 28, *Note 91*
 - Limitations, 34
 - Steam *versus* Electricity, 88
- Sprague, F. J., on Alternating and continuous current operation, 360
- Sprague, General Electric type of controlling appliances, 296
- Springs,
 - Helical, Formulae for, 115
 - Semi-elliptical, Formulae for, 115
- Steam,
 - Economy—Turbine *versus* reciprocating engines, 113
 - Locomotives, *see* Locomotives.
 - Piping arrangement, 107
 - Railways,
 - Axle-box, type of, 455
 - Motor bogie truck design, 433
 - Turbines, *see* Turbines.
- Steam *versus* electric service, 13, 29, 31, 51, 88, 325
- New York Central Railway Tests, 301
- Valtellina Railway, 344
- Steel
 - Axles, qualities for, 460
 - Brake heads, cast steel for, 450
 - Conductivity of, 247
 - Locomotive frames,
 - Soft cast steel, 441
 - Steel plate for, 432
 - Tower for supporting overhead high tension transmission lines, 171
 - Track rails, 269
 - Tyres, Qualities for, 462
- Stewart, Mr. Cost of Cables, 187
- Stone's bronze alloy 456
- Storage Batteries,
 - Auxiliaries—Battery-booster set, 192
 - Modifications, 195
 - Comparison of price in Germany, England and America, 201
 - New York Central Railway Equipments, 236
- Storer on Series *versus* Parallel Control, 76
- Stresses, Axle, 458
- Sub-stations, 172
 - Accumulators, Use of in, 191
 - Comparative costs of Plant with and without accumulators, 200
 - Capacity of Machinery, 212
 - Central London Railway, 208, 212
 - Rotary Converters *versus* Motor Generators, 186
 - Continuous Current Generators, 173
 - Cost of Plant, 198
 - Description of extensive tramway plant in South America, 188
 - Design, 203
 - Equipment of, for New York Central Locomotive tests, 299
 - Location, 241
 - Metropolitan District Railway, 208, 225
 - Metropolitan Railway, 208, 223
 - New York Central and Hudson River Railroad, 208, 232
 - New York Subway, 208, 238
 - North Eastern Railway, 208, 229
 - Polyphase Transmission systems with rotary converter sub-stations, 190
 - Rotary Converters, 145
 - Transforming apparatus, 172
 - Superheating, Advantages, 108
 - Surface Condenser, 110
- Suspension—Nose *versus* Centre of gravity suspension of motors, 451

INDEX

- Suspension Cables, 259
 Copper Conductors, 260
 Insulators, 260
- Switches,
 Electro-pneumatically controlled unit switches, 411
 Oerlikon overhead high tension, 354
- Switchgear, arrangement of, 203
- Swivelling of Bogie, 413
- Synchronous Motors, *see* Motors
- Synchroscope on District Railway, 227
- Szasz on Efficiency in single-phase commutator motors, 421
- TEICHMULLER'S formulæ for calculating permissible current densities, 119
- Temperature,
 Distribution in Cables, 149
 Rise,
 Cables, 118
 Method of estimating, 82
- Third Rail System, 246
 Baltimore and Ohio 1896 Gearless Locomotive, 309
 Overhead System *versus*, 244
 Paris-Orleans Line, 323
 Shoe of New York Central Locomotive, 297
 Under-contact rail, advantages, 254, 302
- Thomas' Soldered Rail Bonds, 278
- Thompson, Elihu—Repulsion Motor, 393
- Three-phase continuous current system, Substation, 172
- Track, Experimental track for New York Central locomotive tests, 298, 302
- Track Rails, *see* Rails
- Tractive
 Effort,
 Effect of gear ratio on, 82
 Light *versus* heavy trains, 86
 Force, Power and Energy at Axles, 40 *et seq.*
 Resistance, *see* Resistance
- Tramway Plant—Description of extensive plant in South America, 188
- Tramways,
 Conductor, Method of suspending, 258
 Spare Generating Plant, 163
- Transformers,
 Losses, 56
 Motor Generators, 173
 Static, 172
 200 kilovolt ampere air blast, 347
- Transmission System, 140
 Cables, cost, construction, etc., 141
 New York Central Locomotive, special line for tests, 299
 Overhead lines, calculation of, 164
 Rotary Converter sub-stations, 190
 Single-phase system, spare line for, *Note* 426
 Steel tower, 171
- Trolley,
 Oerlikon overhead, 354
 Self-reversing Pantograph type, 414
- Trucks, Bogie, 430 *et seq.*
 Axle,
 Boxes, 453
 Guards, 455
 Baltimore and Ohio Railway, 431
 Brake work, 445 *et seq.*
- Trucks, Bogie, *contd.*
 Brill type, 435, 441
 Built up steel frame, description, 434
 Central London Railway, 438
 Motor and trailer brake blocks, 449
 Marshall's design, 439, 441, 447
 City and South London Railway, 431
 Composition of bearings for coach and wagon journals, 455
 District Railway, 439, 441
 Effect of high accelerating rates, 90
 Electrical contact devices, arrangement of, 453
 Equalising lever, 432
 European and American types, 433
 Frame types, 441
 Hadley's motor truck, 441, 447
 Journals, play in brass, 456
 Lancashire and Yorkshire Railway, 435
 Brake work, 450
 Manhattan Elevated Railway, 437, 447
 Material suitable, 432
 Method of attaching motors to bogie, 451
 New York Central Railway, 432
 North Eastern Railway, 434
 Brake work, 450
 Rivets preferable to bolts, 440, 443
 Springs, 444
 Steel, Employment of, 441
 Swing and rigid bolsters, 434
 Valtellina Motor Cars, 343
- Tube Railways,
 High Tractive Resistance, 8
 [*See also* names of Railways.]
- Turbine,
 Generator for operating New York Central Locomotive, 298
 Plan of 10,000 k.w. power station, 130
 Reciprocating engines *versus*, 101, 103, 113
- Tyres, 461
- UNDER Contact Third Rail System, *see* Third Rail System
- Unit Switches, Electro-pneumatically Controlled, 411
- VALATIN'S data for railway motors, 375
- Valtellina Railway,
 Liquid Starting Resistances, 74
 Locomotives, three-phase gearless, 326
 Motor Cars, 343
 Regenerative features, 338
 Steam *versus* electric traction, 344
- Venturi Water Meter, 118
- Verband Deutscher Elektrotechniker, Formulæ for calculating permissible Current Densities, 149
- Voltage,
 Continuous Current Motors, 386
 Drop in uninsulated conductors, Board of Trade Restrictions, 241
 Effect on cost of cables, 145
 Method of calculating generator voltages, 180
 Transforming apparatus, 172
- WARD-LEONARD System of motor control, 351
- Water-tube boilers, 107

INDEX

- Weight,
Electrical Equipment, 29, 43
Geared *versus* Gearless equipment, 372
Loaded train, 7
Motor on axles, 451
Percentage of passenger and freight weight to total train weight, 12
Railway Motors, 373
Ratio between dead and total weight of car, 13
Westinghouse Company,
Exhibition car, 414
Oil Break High Tension Switches, 230
Overhead Conductor and supports, 263
Standard single-phase railway motor, 405
Weston Bros. Leakage Indicators, 222
Wheel(s),
Attachment to axles, 460
Centres, 461
Diameter, 82
Wheels, *contd.*,
Doyle and Brinckerhoff's keyless wheel, 460, 461
Rotational energy of, 21
Wilkesbarre and Hazelton Railroad, Pennsylvania,
Method of protecting live rails, 253
Position of conductor rails, 255
Wilson, Prof., on Electrical and magnetic properties of track, 281
Wind Resistance, 11
Winter-Eichberg type of single-phase Commutator Motors, 393, 394, 417, 418, 422
Wood, Inferiority of to other insulating materials, 251
Worsdell, W. —Motor bogie design, 431
Brake foundation, 447, 450
Wynne, Tractive Resistance Curves, 87
ZOSSEN-BERLIN, *see* Berlin-Zossen Tests

NORTHEASTERN UNIVERSITY LIBRARIES



3 9358 00883829 1

NORTHEASTERN UNIVERSITY LIBRARIES



3 9358 00883829 1